



Koken[®]
EUROPE
50 years



2024-25
Koken TOOL CO., LTD.





INDEX

Z-SERIES
Z-SERIE
SERIES-Z

P021 - 044



Z-SERIES

HAND SOCKETS
HAND STECKSCHLÜSSEL
DOUILLES À MAIN

P045 - 140



HAND

TITAN-SOCKETS & ACCESSORIES
TITAN STECKSCHLÜSSEL UND ZUBEHÖRTEILE
DOUILLES ET ACCESSOIRES TITAN

P141 - 142



TITANIUM

ACCESSORIES
ZUBEHÖRTEILE
ACCESSOIRES

P143 - 180



ACCESSORIES

SCREWDRIVERS
SCHRAUBENDREHER
TOURNEVIS

P181- 186



SCREWDRIVERS

IMPACT SOCKETS
IMPACT STECKSCHLÜSSEL
DOUILLES IMPACT

P187 - 260



IMPACT

SLEEVE-DRIVE SOCKETS
SLEEVE-DRIVE STECKSCHLÜSSEL
DOUILLES, SLEEVE DRIVE

P261- 267



SLEEVE-DRIVE

SOCKETS WITH TURNABLE PLASTIC PROTECTORS
STECKSCHLÜSSEL MIT DREHBAREN SCHUTZHÜLSEN AUS KUNSTSTOFF
DOUILLES A PROTECTIONS PLASTIFIEES

P271- 276



PROTECTOR

INDUSTRIAL SOCKETS
STECKSCHLÜSSEL, INDUSTRIE-AUSFÜHRUNG
CLÉS À DOUILLES, FINISSAGE INDUSTRIEL

P277 - 282



INDUSTRIAL

AUTOMOTIVE TOOLS
WERKZEUGE FÜR KFZ UND NUTZFAHRZEUGE
OUTILS POUR POIDS LOURDS ET VÉHICULES UTILITAIRES

P283 - 304



AUTOMOTIVE

MOTORCYCLE TOOLS
MOTORRAD WERKZEUGE
OUTILLAGE MOTO

P305 - 308



MOTORCYCLE

TOOLS FOR CONSTRUCTION SITES
WERKZEUGE FÜR DAS BAUGEWERBE
OUTILLAGE POUR L'INDUSTRIE DU BÂTIMENT

P309- 315



CONSTRUCTION

SPARE PART SETS
ERSATZTEILSÄTZE
PIÈCES DE RECHANGE

P317- 321



SPARE PART

Pictograms Socket openings / Bit shape

	FLAT DRIVE® (6-point)		TORX® (E)		TORX® (T)
	FLAT DRIVE® (12-point)		NUT GRIP® / TORX® (E)		Tamper-Resistant TORX® (TH)
	NUT GRIP®		TORXplus® (EP)		TORXplus® (IP)
	NUT GRIP® (3-ball)		Tamper-Resistant TORXplus® (EPR)		Tamper-Resistant TORXplus® (IPR)
	Surface Drive		LH-STIX® (LH-S)		Triple-Square(XZN)
	PATHFINDER®		Bit Holder		Triple-Square with Hole(XZN)
	Flare Nut		Phillips		Ribe-CV
	Square		Slotted		POLYDRIVE
	Double Square		Hexagon		Double-Hexagon
	Stud Bolt Puller		PZ		Socket Set on Rail
	NUTTWISTER®		Square Male		

Pictograms Mechanics / Specification

	S.O.D.H®-System		Thin-Walled(6-point)	$\frac{1}{4}''$ $\frac{1}{4}''$	$\frac{1}{4}''$ (6.35mm) Sq. Dr.
	S.O.D.H®-System (4750 series)		Thin-Walled(12-point)	$\frac{3}{8}''$ $\frac{3}{8}''$	$\frac{3}{8}''$ (9.5mm) Sq. Dr.
	Two-Step Dog		with Magnet	$\frac{1}{2}''$ $\frac{1}{2}''$	$\frac{1}{2}''$ (12.7mm) Sq. Dr.
	Three-Step Dog		20 tooth Gear	$\frac{5}{8}''$ $\frac{5}{8}''$	$\frac{5}{8}''$ (15.9mm) Sq. Dr.
	Quick Release Button		24 tooth Gear	$\frac{3}{4}''$ $\frac{3}{4}''$	$\frac{3}{4}''$ (19.0mm) Sq. Dr.
	Flexible Head		30 tooth Gear	1" 1"	1"(25.4mm) Sq. Dr.
	Swivel Head		36 tooth Gear	$1\frac{1}{2}''$ $1\frac{1}{2}''$	$1\frac{1}{2}''$ (38.1mm) Sq. Dr.
	L/R Marking		44 tooth Gear	$2\frac{1}{2}''$ $2\frac{1}{2}''$	$2\frac{1}{2}''$ (63.5mm) Sq. Dr.
	Oval Shape Shank		45 tooth Gear	$3\frac{1}{2}''$ $3\frac{1}{2}''$	$3\frac{1}{2}''$ (88.9mm) Sq. Dr.
	Wobble-Fix		60 tooth Gear		Caution
			72 tooth Gear		Modification



Reproduction in whole or in part without proper and prior authorization is prohibited.
Der Nachdruck, im ganzen oder auch auszugsweise, bedarf unserer ausdrücklichen, vorherigen Genehmigung.
La reproduction de ce catalogue en tout ou en partie sans autorisation préalable est interdite.

Specifications or designs of any product in this catalogue are subject to change without notice.
Wir behalten uns das Recht vor, jedes in diesem Katalog gezeigte Werkzeug, auch ohne vorherige Ankündigung, in Ausführung und Design ändern zu dürfen.
Nous nous réservons le droit de modifier les modèles et les dimensions des outils présentés dans ce catalogue et ce sans autre notification préalable.



■ TEST AND LABORATORY
 ■ TESTLABOR
 ■ TEST AU LABORATOIRE

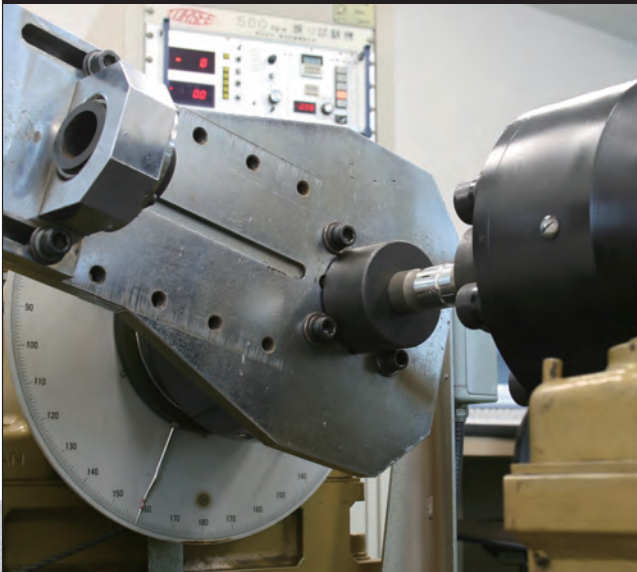

Ko-ken uses a variety of test equipment. Strength is measured by the Static Load Test Machine that can measure torque load up to 5,000Nm. Durability is measured by the Cyclic Test Machine and corrosion resistance testing is done by the Salt Spray Test Machine. The test results are used to improve our standard products and assist with new product design and development.

Wir verfügen über die verschiedensten Testgeräte:
 -Die Festigkeitseigenschaften der Werkzeuge werden mit einer statischen Drehmoment-Testmaschine, die Prüfdrehmomente bis 5.000Nm erzeugen kann, überprüft.
 -Die Dauerbelastbarkeit wird mit einer Testmaschine durchgeführt mit der die Werkzeuge zyklisch in langen Testreihen belastet werden.
 - Der Korrosionsschutz wird regelmäßig mittels Salzsprühnebelprüfung kontrolliert.
 Die gewonnenen Testergebnisse ermöglichen eine stetige Verbesserung der Standardwerkzeuge und helfen bei der Entwicklung neuer Produkte.

Ko-ken utilise plusieurs types de tests. La résistance est mesurée par une installation de test à charge statique d'une capacité de 5.000 Nm. La durée de vie est déterminée par une machine à cycles et la résistance à la corrosion par une installation à projection de sel.
 Les résultats de ces tests sont destinés à améliorer nos produits standards et à assister au développement de nouveaux produits.



■ DESIGN AND DEVELOPMENT
 ■ ENTWICKLUNG UND DESIGN
 ■ DESIGN ET DEVELOPPEMENT

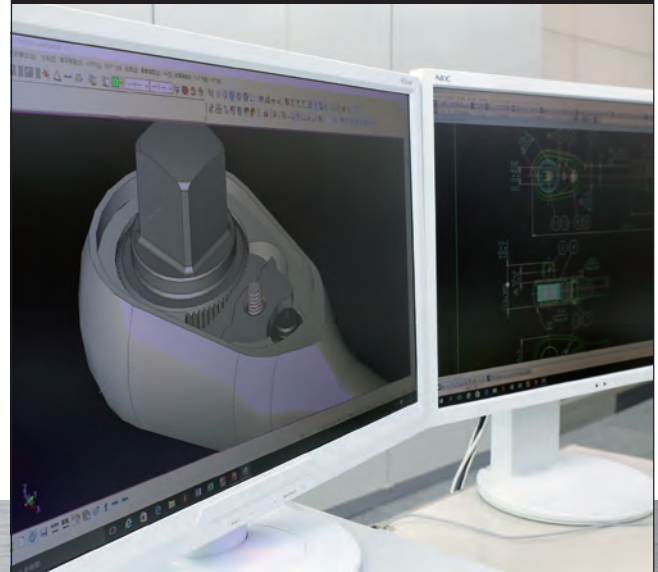

The 3D-CAD is used to improve standard products, designing new products and making customized items for special requirements. Trial products are regularly developed, manufactured and tested to improve the durability, appearance and functionality of all tools produced by Ko-ken.

3D-CAD Programme helfen uns sowohl, bei der Weiterentwicklung unserer Standardwerkzeuge, als auch beim Designen neuer Produkte und beim Entwerfen von Sonderanfertigungen. Um die Zuverlässigkeit und Funktionalität unserer Werkzeuge zu verbessern, werden ständig Versuchswerkzeuge gefertigt.

La technique CAD-3D est utilisée pour l'amélioration des produits standards, le design des nouveaux produits et la réalisation d'outils spéciaux. Des séries d'essai sont régulièrement développées, fabriquées et testées pour améliorer l'apparence et la fonctionnalité de tous les produits Ko-ken.



■ FORGING
 ■ SCHMIEDEN
 ■ FORGEAGE



The Forming machines are used for the forging process. These machines can produce mass quantities of sockets and parts with high accuracy that ordinary drop forging machines can not achieve. On the other hand, ordinary forging machines are also used for small production runs.

Zum Schmieden verwenden wir eigene Umformmaschinen.

Diese Maschinen werden zur Produktion großer Stückzahlen von Steckschlüsseln und Betätigungswerkzeugen verwendet mit einer Genauigkeit, die mit normalen Gesenkschmiede Maschinen nicht gewährleistet werden kann.

Bei kleineren Fertigungsserien werden zur Fertigung auch kleinere Gesenkschmiedemaschinen verwendet.

Des machines de formage à froid sont utilisées. Ces machines peuvent produire en masse les douilles et accessoires avec une précision supérieure à la forge conventionnelle. Toutefois, pour des petites séries, des machines à forger traditionnelles sont également utilisées.

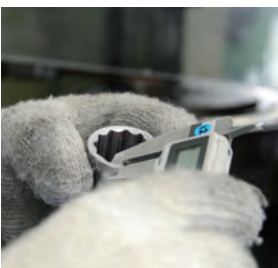

■ TURNING
 ■ DREHEN
 ■ TOURNASAGE



The forged steel is turned into required shapes and dimensions. The MC (Machining Center) operates with extraordinary speed and precision. The article number, size, logo, production number, and MADE IN JAPAN are marked on the products after the turning process has been completed.

Der geschmiedete Stahl wird nun auf die endgültige Form abgedreht.

Unser Maschinenzentrum arbeitet hier mit außergewöhnlicher Geschwindigkeit und Präzision.

Nach dem Drehvorgang wird das Werkzeug mit Artikelnummer, Abmessung, Logo, Produktionsnummer und MADE IN JAPAN markiert.

Après la forge, les pièces sont usinées à la bonne dimension par tournage. Les centres d'usinage travaillent avec une précision et une vitesse extraordinaire.

Le numéro d'article, la dimension, le logo Ko-ken, un numéro de production ainsi que la mention « Made in Japan » sont gravés sur le produit après tournage.



■ HEAT TREATMENT
■ HÄRTEN
■ DURETE



To make the tools stronger and more durable, proper heat treatment is critically important. The temperature and the time of the heat treatment are strictly regulated by a very accurate control device.

Um die optimale Stabilität und Festigkeit der Werkzeuge zu erreichen ist der Härtingsprozess der Werkzeuge von höchster Wichtigkeit.

Die hohe Genauigkeit von Temperatur- und Dauer der Wärmebehandlung werden durch sehr genaue Regeleinrichtungen in den Härteöfen erreicht.

Pour la résistance et la dureté de l'outil, un traitement thermique adapté est indispensable. Les températures et la dureté de traitement sont très précisément contrôlées.



■ INSPECTION
■ MESSEN UND PRÜFEN
■ CONTRÔLE

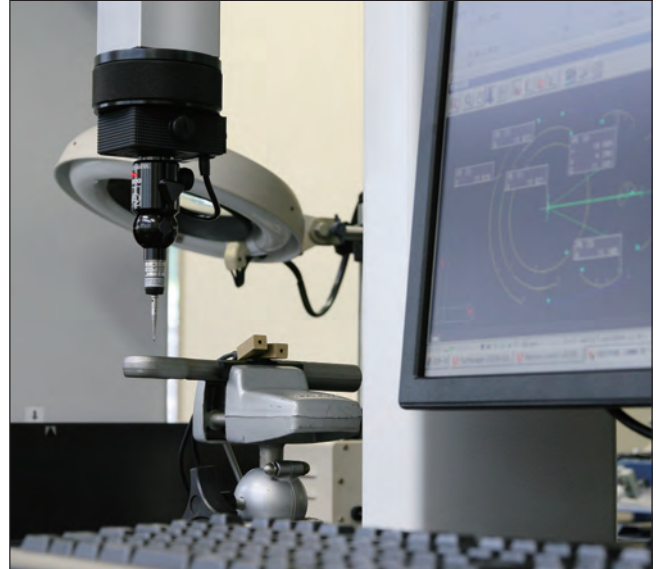

Our products are periodically checked at each production process by inspection devices. Highly accurate 3-D measuring instruments are used to inspect and confirm dimensions.

Unsere Produkte werden periodisch nach jedem Produktionsprozess überprüft. Hierzu verwenden wir sehr genaue 3D Messgeräte.

Nos produits sont contrôlés périodiquement à chaque étape de leur fabrication.

Des instruments de mesure en 3D, très précis sont employés pour la vérification des dimensions.





FLAT DRIVE®

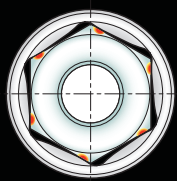

Flat Drive is designed to guarantee a flat surface contact between the socket and the bolt/nut.

The Flat contact reduces wear and allows to transmit a higher torque value.

The Flat Drive System is also used for the square drive end as well as the hexagonal or bi-hexagonal openings of the socket.

Das Flat Drive Design sorgt für die optimale Kraftübertragung zwischen den Flächen des Steckschlüssels und der Schraube. Dies erlaubt eine Übertragung von höheren Drehmomenten. Das Flat Drive System findet ebenfalls bei allen Antriebsvierkanten sowie bei 6-kant und 12-kant Profilen Verwendung.

Le profil Flat Drive garantit un contact optimal entre la douille et l'écrou. Ce contact « à plat » réduit l'usure et permet la transmission d'un couple plus élevé. Ce système Flat Drive est utilisé pour tous les carrés conducteurs ainsi que pour toutes nos douilles 6-pans et 12-pans.

SOCKETS STECKSCHLÜSSEL DOUILLES



NUT GRIP®



Twin balls at the 6-point opening hold bolt/nut tightly for safe and reliable work.

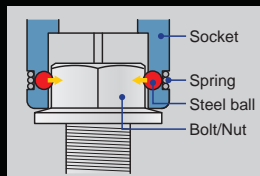

Die zwei Kugeln in der 6-kant Öffnung unserer NUT GRIP Steckschlüssel halten die Schraube sicher im Steckschlüssel. Dies erlaubt ein Arbeiten auch an schwer zugänglichen Stellen.

Les 2 billes dans l'ouverture du 6-pans de la douille retiennent l'écrou de manière sûre et efficace.

SURFACE DRIVE



Surface drive sockets are designed to retain contact with the flat sides of the nut in order to reduce nut wear.

These sockets are ideal for using on polished nuts, aluminum nuts and nuts with worn out points.

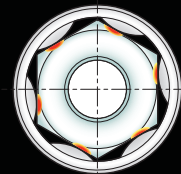

Das Profil unserer Surface-Drive Steckschlüssel greift die Schraube an deren Flächen.

Dies sichert eine höhere Kraftübertragung und verhindert ein Durchrutschen des Steckschlüssels. Diese Steckschlüssel eignen sich besonders für polierte Schrauben, Aluminium Schrauben und Schrauben bei denen die Ecken bereits abgerundet sind.

Notre profil Surface Drive assure le contact entre la douille et les plats de l'écrou. Ceci réduit l'usure et permet la transmission d'un couple plus élevé. C'est une solution idéale pour les écrous polies, celles en aluminium ou arrondies.

PATHFINDER®



The beveled flats of the 6-point opening of the PATHFINDER socket engage the nut almost immediately. PATHFINDER sockets are ideal for using with power tools in automatic assembly processes, as the power tool does not have to be totally stopped for the socket to engage the nut.

Da die Maschine nicht nach jedem Schraubvorgang angehalten werden muss, ergibt sich eine erhöhte Produktivität, die sich bei vollautomatischen Maschinen (Mehrschrauberschrauben) ganz besonders auswirkt.

Les parois en biais du 6-pans des douilles PATHFINDER assurent l'engagement quasi immédiat de l'écrou. Le fait de ne pas devoir arrêter la machine après chaque serrage procure un gain de productivité particulière appréciable dans les chaînes de montage automatiques.

RATCHET HANDLE KNARRENGRIFFE MANCHE À CLIQUET



J-Type
Rubber Grip
Gummigriff
Manche en matière plastique



P-Type
Plain Grip
Glatter Griff
Manche lisse



N-Type
Knurled Grip
Gerändelter Griff
Manche moletée



SODH®-System

Two dogs are located in the ratchet body so that the dogs and springs are held securely in place, allowing the reversing lever and dog to switch smoothly.

The torque load on the gear is transmitted vertically to the dog, and in turn, down the ratchet handle. This mechanism locks gears tightly in place while torque is being applied, thus avoiding any gear slippage.

locks gears tightly in place while torque is being applied, thus avoiding any gear slippage.

Die zwei Sperrklinken sind fest im Knarrenkörper verankert, die Federn sind dadurch fest fixiert.

Die Umschaltung der Knarre erfolgt leicht und sicher.

Die Kraft des Knarrenzahnrad wird vertikal auf die Sperrklinken übertragen, dadurch wird das Überspringen des Knarrenmechanismus sicher vermieden.

Les 2 rochets sont insérés dans le corps du cliquet. De ce fait les ressorts sont également fermement fixés. L'inversion se produit sans à-coups. Ce mécanisme assure aussi une transmission du couple sans risque de ripage.



Two-Step Dog

Two flats hold two teeth of the ratchet gear, thus increasing the maximum torque load of the ratchet compared with a single-step system.

Die Kraft wird über zwei Zähne des Knarrenzahnrades übertragen. Dies erlaubt eine höhere Kraftübertragung gegenüber Knarren mit einem Zahn Mechanismus.

La force est transmise par les deux dents du mécanisme. Ceci permet un couple plus élevé par rapport aux systèmes à une seule dent .



Three-Step Dog

Two dogs are set in the same axis, and the three teeth hold the ratchet gear. The enlarged contact area produces an about 10% higher torque value and the SODH®-System provides smooth and light movements.

Die scharnierartig eingelagerten Sperrklinken haben jetzt jeweils drei Zähne im Eingriff. Die dadurch vergrößerte Greiffläche erhöht das maximale Drehmoment um ca. 10%. Auch diese Knarre besticht durch ihren leichten und geschmeidigen Lauf.

Les deux rochets étant placés sur le même axe, les trois dents de l'engrenage sont engagées en permanence. Ce système assure une augmentation de 10% du couple maximum admissible. Ce cliquet se caractérise également par son fonctionnement souple et sans à-coup.



SHAPE OF HANDLE
FORMGEBUNG DER GRIFFE
MODELE DE POIGNEE



OVAL SHAPE SHANK



Unique designed oval shape shank provides extra strength and durability.

Der einzigartige ovale Schaftquerschnitt in Belastungsrichtung erhöht die Stabilität und Widerstandsfähigkeit.

La section ovale, orientée dans le sens de l'effort, confère à cet outil une résistance et une durée de vie incomparable.

KNURLING

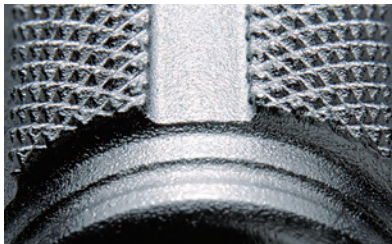

Rotation and general handling of extensions with oily hands is greatly improved with the **Koken** developed 6 point knurling. Also the **Koken** 6 point knurling stops the extensions from rolling around the work area.

Durch die von **Koken** entwickelte 6 fache Rändelung wird die Handhabung deutlich erleichtert.

Außerdem wird das Herumrollen der Verlängerungen wirksam verhindert.

La manipulation des rallonges est grandement facilitée par le profil moleté développé par **Koken**. Ce même profil empêche le roulement intempestif des rallonges sur le plan de travail.



WOBBLE-FIX



TWO WAY USAGE

- a) In a fixed position, as a normal extension bar
- b) In a half-fixed position, as a flexible extension bar providing a 15° angle operation.

Winkelverlängerungen lassen sich in zwei Einstellungen verwenden

- a) voll eingesteckt und starr
- b) halb eingesteckt, mit einem Arbeitswinkel von 15°.

Deux utilisations possibles

- a) comme rallonge normale, dans une position fixe
- b) comme une rallonge angulaire avec une possibilité d'inclinaison jusqu'à 15°

Fix

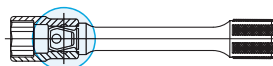

Wobble

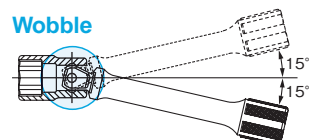

STUD BOLT PULLER / SETTER STEHBOLZENAUSDREHER UND STEHBOLZENSETZER EXTRACTEURS DE GOUJONS



STUD BOLT PULLER STEHBOLZENAUSDREHER DEGOUJONNEUSES



Hexagon body design can lessen the excessive load on cages and rollers inside the pullers.

Der neue Körper mit sechs Walzenmulden verteilt den Druck auf den Käfig und die Walzen weitaus vorteilhafter.

La forme hexagonale du corps améliore les tolérances.

Elle répartit l'effort de façon plus uniforme sur la cage et les rouleaux.



STUD BOLT SETTER STEHBOLZENSETZER MONTE-GOUJONS



A special socket for installing a stud bolt.

Inside steel ball prevent the stud bolt stuck onto the socket. After installing a stud bolt, turn to anti-clockwise to removing the socket.

Spezialwerkzeug zum Setzen von Stehbolzen. Der Bolzen trifft im Werkzeug nur auf die gehärtete Stahlkugel, was die Kontaktfläche verringert. Nach dem Setzen des Stehbolzens kann das Werkzeug im Linkslauf vom Stehbolzen abgezogen werden.

Douilles spéciales pour monter les goujons. Le goujon est en contact avec une bille d'acier pour l'empêcher d'adhérer à la douille. Après avoir posé le goujon, tourner dans le sens antihorlogique pour le retirer

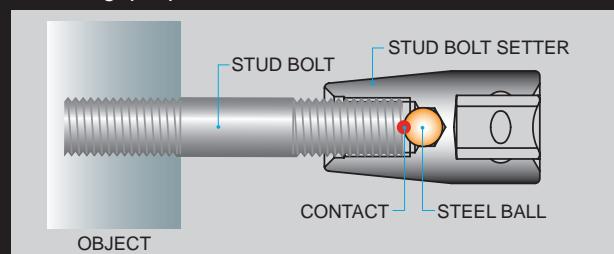



ATTACK DRIVER®

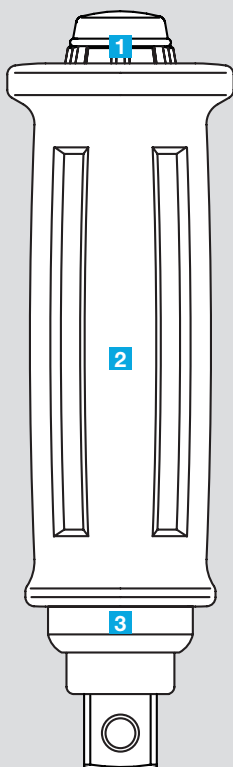

1 Black Finish - Schwarze Schlagplatte - Tête de frappe noire



Black finished head prevents peeling off the chrome plate by striking the head.
 Der Schlagkopf wurde geschwärzt, um das Abblättern von Chrompartikeln zu verhindern.

La finition noire de la tête évite l'écailage du chrome lors de la frappe.



2 Original Body Shape - Einzigartige Formgebung - Forme unique du corps



Original design of the body achieved higher grip.

Die Gestaltung des Handschlagschrauberkörpers erhöht Führung und Griffigkeit des Werkzeuges.

Le dessin original du corps permet une meilleure prise en main de l'outil.

1 3 Heat Treatment - Wärmbehandlung - Traitement thermique

Special heat treatment is applied on the body. Hardness of striking part is slightly softer to prevent cracks.

On the other hand, Cam part converts the striking power to twisted by striking with hammer, therefore, this part is finished with higher hardness to improve anti-wear.

Besondere Aufmerksamkeit wurde der Wärmbehandlung des Körpers gewidmet, indem die Härte des Schlagendes leicht verringert wurde, um ein Reißen durch Hammerschläge zu vermeiden. Dagegen wurde die Härte und somit die Belastbarkeit in dem Teil des Körpers erhöht, wo der Schlag in Drehkraft umgesetzt wird.

Un traitement thermique spécifique est appliqué sur le corps de l'outil. La dureté des parties de frappe est légèrement inférieure pour diminuer le risque de casse. D'un autre côté, le mécanisme qui transforme la force de frappe en rotation est plus dure pour augmenter la résistance à l'usure.

3 Spring - Feder - Ressort

Stronger spring is adapted to convert the striking power efficiently to twisting power.

Eine extrem widerstandsfähige Feder sorgt für die unmittelbare Übertragung der Schlagkraft und ihre Umsetzung in wirksame Drehkraft.

Un ressort très résistant est monté sur l'outil pour convertir la force de frappe en force de torsion très efficace.





FREE-TURN GRIP



SPINNING CROSS WRENCH DREHBARER KREUZSCHLÜSSEL CLE EN CROIX RAPIDE



The shaft of cross wrench turns freely inside the knurled grip. The cross bar is removable for easy storage in a compact space.

Der Schaft des Kreuzschlüssels dreht sich frei in dem kordierten Griff. Die Querstange kann entnommen werden, das erlaubt eine platzsparende Aufbewahrung (z.B. im Fahrzeug)

La tige de la clé tourne librement dans sa poignée gaufrée. La barre transversale est démontable pour le rangement aisé de l'outil.



FLEXIBLE SPEEDER GELENKGRIF-FWINDE VILEBREQUIN RAPIDE

Free-turn grip allows speedy removal or replacement of wheel nuts. It can also be used as a hinge handle to tighten or loosen the nuts.

Der frei laufende Griff ermöglicht eine schnelle Radmontage. Das Werkzeug kann zusätzlich als Gelenkgriff verwendet werden.

La poignée à rotation libre permet l'enlèvement et la pose rapide des écrous de roue. Elle peut également être utilisée comme poignée articulée.



SPINNING SLIDE T-HANDLE FREILAUF T-GRIFF POIGNEE EN T RAPIDE

The knurled grip is attached in the middle of shaft for free turning. Oval shaped cross bar prevents the bar from turning inside the shaft during use.

Der kordierte Freilauf-Griff befindet sich in der Mitte des Schaftes. Der Quergriff mit ovalem Querschnitt verhindert das Verrutschen.

La poignée gaufrée est fixée au milieu de la tige et est à rotation libre. La barre transversale est de forme ovale pour l'empêcher de tourner pendant l'utilisation.



IMPACT WHEEL NUT SOCKET IMPACT RADMUTTERN STECKSCHLÜSSEL DOUILLES POUR ÉCROUS DE ROUE, IMPACT



PLASTIC PROTECTOR KUNSTSTOFF HÜLSE PROTECTION EN PLASTIQUE



A detachable plastic protector is fitted to the socket to prevent damage to the wheel when working in tight areas.

The socket size and Ko-ken Mark printed on the shaft makes it easier to see if the socket is still rotating or stopped.

Zum Schutz empfindlicher Leichtmetallfelgen ist eine drehbare und abnehmbare Kunststoff Hülse an dem Steckschlüssel montiert. Die aufgedruckten Markierungen am Werkzeugschaft zeigen außerdem ob das Werkzeug steht oder rotiert.

La douille est pourvue d'un insert en plastique détachable. Il sert à prévenir tout dommage aux jantes lors de l'utilisation des douilles.

Le marquage sur la tige rend l'identification des douilles très facile.

EXTRA THIN-WALLED EXTRA DÜNNWANDIG PAROIS EXTRA MINCES



Thin-walled shape and 110mm length gives extra reach for nuts recessed deep inside the wheel.

They are ideal for aluminum wheel nuts where access to nut is very tight. Colour coded shafts make size identification easy.

SPARK PLUG SOCKET ZÜNDKERZEN STECKSCHLÜSSEL DOUILLES AVEC RESSORTS RETENUE POUR BOUGIES



CLIP TYPE

This revolutionary new spark plug socket is designed to securely grip a spark plug at its hexagonal part by two stainless spring clips.

An internal brass guide holds the clips in place, which ensures perfect alignment of the spark plug into the threaded plughole of the cylinder head, thus preventing thread damage.

The brass guide also eliminates stress loading and possible damage to the ceramic insulator of the spark plug.

Zwei solide Federn aus rostfreiem Stahl fassen den Sechskant der Zündkerze und drücken ihn an den Anschlag der Messing-Führungsbuchse. Jetzt sitzt die Kerze genau senkrecht zur Achse des Steckschlüssels. Das Einschrauben kann ohne Beschädigung der Gewindegänge im Motorblock und ohne Druck auf den Isolator der Kerze erfolgen.

Deux puissants ressorts en acier inoxydables maintiennent la bougie sur sa partie hexagonale tout en l'appliquant contre la douille de guidage en laiton. L'alignement parfait de la bougie dans l'axe de l'outil permet à l'opérateur de poser celle-ci avec beaucoup de précision en réduisant au maximum les risques d'endommagement au filetage du bloc ainsi qu'à la partie en céramique de la bougie.

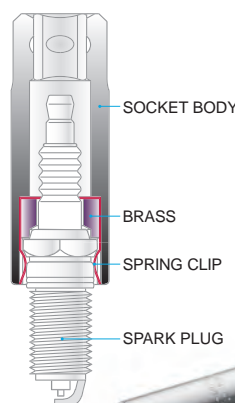

Universal Joint Universal Gelenk Joint universel



Hexahedral engagement achieved with compact design

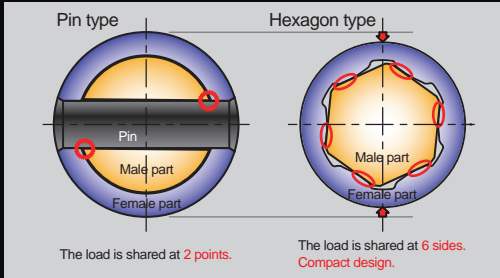

Ball type universal joints use a new structure of joint mechanism without a pin. Being connected by mutually engaged hexahedrons, the load is dispersed across the whole outer circumference. High durability is obtained with this innovative, compact design.

Unsere neuen Kugelgelenke haben einen Gelenkmechanismus ohne Bolzen. Durch die miteinander verbundenen sechs Flächen wird die Last über den gesamten Außenumfang verteilt. Diese innovative kompakte Bauweise erhöht die Lebensdauer des Gelenkes erheblich.

Nos joints articulés utilisent un nouveau mécanisme d'articulation sans boulons. Grâce aux six surfaces interconnectés, la charge est répartie sur toute la circonférence extérieure. Cette conception innovante et compacte augmente considérablement la durée de vie de l'articulation.



Locking Adaptor VERRIEGELUNGSADAPTER L'ADAPTATEUR DE VERROUILLAGE



Impact sockets can be attached or detached on the LOCKING ADAPTOR for safety just by sliding the holder rather than using a pin and an O-ring. It can reduce the time to change a socket, especially when you need to use a variety of socket sizes.

Die Kraftschraubereinsätze werden durch einfaches Verschieben der Hülse am Adapter, ohne Verwendung von Stift und O-Ring, sicher gehalten bzw. entriegelt. Die Zeit für den Wechsel eines Steckschlüssels wird dadurch deutlich verkürzt, insbesondere wenn Sie eine Vielzahl von verschiedenen Abmessungen verwenden müssen.

Vos douilles à chocs peuvent être facilement maintenues et libérées en déplaçant le support de l'adaptateur sans devoir utiliser la goupille et le joint. Le temps nécessaire pour changer une clé à douille est considérablement réduit, surtout si vous devez utiliser une variété de dimensions différentes.

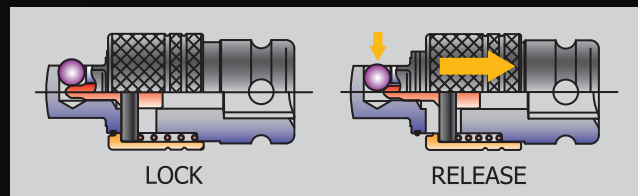



NUTTWISTER®

The NUTTWISTER's six teeth have a special helical structure that tapers inward, locking onto the rounded-off bolt or nut for removal. NUTTWISTER can be applied to any round bolts like stud bolts, cap bolts, provided the correct size is used and the bolt or nut is unbroken.

Die sechs Zähne des NUTTWISTER's haben eine spezielle schraubenförmige Struktur, die sich nach innen verjüngt und sich dadurch mit der abgerundeten Schraube oder Mutter verbeißt.

Der NUTTWISTER kann auf alle Rundbolzen wie Stehbolzen und Zylinderschrauben verwendet werden, unter Voraussetzung dass die richtige Größe verwendet wird und die zu lösende Schraube oder Mutter nicht gebrochen ist.

Les six dents du NUTTWISTER ont une structure hélicoïdale spéciale qui se rétrécit vers l'intérieur et mord avec la vis ou l'écrou arrondi.

Le NUTTWISTER peut être utilisé sur tous les boulons ronds tels que les boulons filetés et les vis à tête cylindrique, à condition que la taille correcte soit utilisée et que la vis ou l'écrou à desserrer ne soit pas cassé.

BOLTTWISTER®



Use the BOLTTWISTER to remove a broken bolt whose head has come off.

After drilling a hole in the center of the broken bolt, insert BOLTTWISTER into the hole and turn it counterclockwise until it sticks. The bolt can be removed by continuing to turn it.

Verwenden Sie unsere BOLTTWISTER um gebrochene Schrauben deren Kopf abgebrochen ist zu lösen.

Nachdem Sie ein Loch in der Mitte des gebrochenen Bolzens gebohrt haben, stecken Sie den BOLTTWISTER in das Loch und drehen ihn gegen den Uhrzeigersinn bis er klemmt.

Der Bolzen kann nun durch weiteres Drehen entfernt werden.

Utilisez notre BOLTTWISTER pour enlever une vis cassée dont la tête est cassée.

Après avoir percé un trou au centre du boulon cassé, insérez le BOLTTWISTER dans le trou et tournez le dans le sens inverse des aiguilles d'une montre jusqu'à ce qu'elle se bloque.

Le boulon peut maintenant être retiré en le tournant davantage.

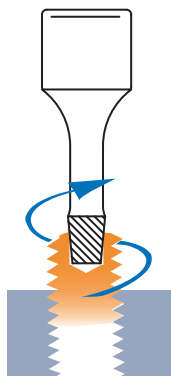

TORX® / TORXplus® & LHSTIX®

TORX® / TORXplus® and **LHSTIX®** are recognized as three of the most efficient fastening systems because of their ability to transfer greater torque, reduce end load and virtually eliminate tool slippage.

Durch die Fähigkeit größere Drehmomente zu übertragen sind **TORX® / TORXplus®** und **LHSTIX®** bekannt als die drei effizientesten Befestigungssysteme.

TORX® / TORXplus® et **LHSTIX®** sont reconnus comme étant trois systèmes de vissage particulièrement efficaces. Ils permettent en effet de transmettre des couples particulièrement élevés.

TORX® & TORX plus®



TORX® is a registered trademark of **CAMCAR Innovations**.
TORX® ist ein registriertes Markenzeichen der Firma **CAMCAR Innovations**.
TORX® est une marque déposée de **CAMCAR Innovations**.

Koken TOOL CO., LTD. holds the official license to use the trademark **TORX®**.
Koken TOOL CO., LTD. hält die offizielle Lizenz um das Markenzeichen **TORX®** benutzen zu dürfen.
Koken TOOL CO., LTD. est officiellement licencié pour l'usage de cette marque **TORX®**.

TORXplus® is a registered trademark of **CAMCAR Innovations**.
TORXplus® ist ein registriertes Markenzeichen der Firma **CAMCAR Innovations**.
TORXplus® est une marque déposée de **CAMCAR Innovations**.

Koken TOOL CO., LTD. holds the official license to use the trademark **TORXplus®**.
Koken TOOL CO., LTD. hält die offizielle Lizenz um das Markenzeichen **TORXplus®** benutzen zu dürfen.
Koken TOOL CO., LTD. est officiellement licencié pour l'usage de cette marque **TORXplus®**.

LHSTIX®

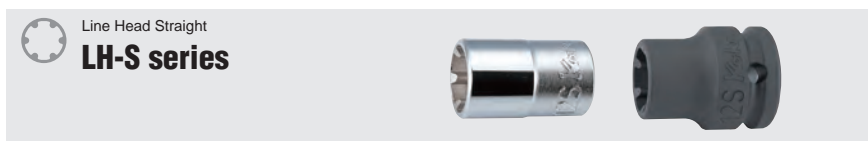

LHSTIX® is a registered trademark of **OSG SYSTEM PRODUCTS CO., LTD.**
LHSTIX® ist ein registriertes Markenzeichen der Firma **OSG SYSTEM PRODUCTS CO., LTD.**
LHSTIX® est une marque déposée de **OSG SYSTEM PRODUCTS CO., LTD.**

Koken TOOL CO., LTD. holds the official license to use the trademark **LHSTIX®**.
Koken TOOL CO., LTD. hält die offizielle Lizenz um das Markenzeichen **LHSTIX®** benutzen zu dürfen.
Koken TOOL CO., LTD. est officiellement licencié pour l'usage de cette marque **LHSTIX®**.

Registered Trademarks / Eingetragene Warenzeichen / Marque déposée

Koken®



Koken TOOL CO., LTD.®

HIGH PERFORMANCE TOOLS OF CONVINCING QUALITY

山下工業研究所®

山下工研®

SODH®-System

Flatdrive®

ATTACK DRIVER®

HANDY-ENDY®

PATHFINDER®

Nut Grip®

LOCK NUT BUSTER®

NUT TWISTER®

BOLT TWISTER®

Ko-ken Factory / Das Ko-ken Werk / L'usine Ko-ken



Warranty / Garantie / Garantie

WARRANTY

The trade mark **Kokon** is your unqualified warranty against any defect in material or workmanship. Each **Kokon** tool is built to more than meet the requirements of its intended use and is carefully checked before leaving the factory. Any **Kokon** tool which fails because of defective material or workmanship will be repaired or replaced through your **Kokon** dealer, to the exclusion of any further liability.

GARANTIE

Kokon TOOL CO.,LTD. Shizuoka, Japan, garantiert Ihnen die einwandfreie Qualität und Ausführung ihrer Produkte. Jedes Werkzeug der Marke **Kokon** ist für Höchstleistungen konstruiert und wird vor Verlassen der Fabrik sorgfältig geprüft. **Kokon** TOOL CO.,LTD. repariert oder ersetzt über ihre Händler unter Ausschluss jeglicher weitergehenden Haftung jedes fehlerhafte **Kokon** Produkt kostenlos.

GARANTIE

La fabrique **Kokon** TOOL CO.,LTD. Shizuoka, Japon, garantit la qualité irréprochable et le traitement absolument impeccable des outils portant la marque **Kokon**. Chaque outil **Kokon** quittant la fabrique est contrôlé soigneusement. La fabrique s'engage à réparer ou remplacer gratuitement tout défaut de matière ou de fabrication par l'intermédiaire de ses distributeurs, à l'exception d'une responsabilité étendue.

ISO9001







SAFETY
ADVISER

SICHERHEITS-
RATGEBER

MESURES
DE SÉCURITÉ

General / Allgemeines / Généralités

- (a) Make sure you use the right type socket, whose opening fit the nut.
Verwenden Sie immer den richtigen Steckschlüssel und überzeugen Sie sich davon, ob er auch auf die Mutter passt.
Utilisez toujours la bonne clé et assurez-vous qu'elle est rigoureusement adaptée à l'écrou.
- (b) For use on electric or air IMPACT Wrenches select IMPACT Sockets only.
Auf elektrischen oder pneumatischen Schlagschraubern dürfen nur hoch belastbare IMPACT-Steckschlüssel und Zubehörteile gesteckt werden.
Sur des vis à fixer par machines à chocs pneumatiques ou électriques n'utilisez que des clés à douille IMPACT et des accessoires IMPACT capables de résister à une haute sollicitation.
- (c) When using nut runners or IMPACT Wrenches wear safety goggles.
Tragen Sie bei der Anwendung von Schraubern stets eine Schutzbrille.
En opérant avec des visseuses et des machines à chocs, portez toujours des lunettes de protection.
- (d) Plastic or rubber handles are not intended to act as insulation.
Plastik-oder Gummigriffe stellen keinen Isolierschutz dar.
Les poignées en plastique ou en caoutchouc ne garantissent aucune isolation électrique.
- (e) Never substitute a HAND Socket for a INDUSTRIAL Socket or an IMPACT Socket, or a INDUSTRIAL Socket for an IMPACT Socket.
Nehmen Sie deshalb niemals anstelle eines INDUSTRIAL-oder IMPACT-Werkzeuges ein HAND-Werkzeug oder anstatt eines IMPACT-Werkzeuges ein INDUSTRIAL-Werkzeug.
Ne vous servez donc jamais d'un outil à main au lieu d'un outil INDUSTRIAL ou IMPACT ou d'un outil INDUSTRIAL au lieu d'un outil IMPACT.
- (f) Items in this catalogue marked  can be loaded to torque values which may cause breakage. In the interest of your own safety always apply load evenly and progressively to avoid breakage and possible injury.
Die mit  gekennzeichneten Artikel können bei Überbelastung zu Bruch gehen. Aus Gründen Ihrer eigenen Sicherheit sollten die betreffenden Werkzeuge nie ruckartig, sondern nach und nach belastet werden, um Bruch, und damit verbundene mögliche Verletzungen zu vermeiden.
Il est possible d'appliquer aux articles marqués  des couples de serrage susceptibles d'occasionner leur rupture. Pour votre propre sécurité, veuillez toujours appliquer la charge d'une manière uniforme et progressive. Ceci pour éviter ruptures et accidents.
- (g) Make sure to lock the impact sockets on driving tools with Pin / O-Ring or C-Ring.
Verwenden Sie Impact Steckschlüssel nie ohne Sicherungsring und Stift oder alternativ mittels unserer C-Ringe.
Ne jamais utiliser de douille à choc sans sécurité. (Anneau et goupille ou crochet en C)

Sockets / Steckschlüssel / Douilles

Sockets showing cracked walls, battered points or other marks of wear are to be replaced.

Steckschlüssel mit Haarrissen, abgestossenen Kanten oder mit anderen Verbraucherscheinungen sind umgehend zu ersetzen.

Les clés qui présentent des fissures capillaires, ou autres signes d'usure doivent être immédiatement changées.

Ratchets/Handles / Knarren/Griffe / Cliquets/Poignées

A ratchet is not a hammer.

Eine Knarre ist kein Hammer.

Un cliquet n'est pas un marteau.

Never use loose pipes or other improvised attachments on handles for increased leverage.

Setzen Sie niemals lose Rohre oder andere Hilfsstücke auf Steckschlüsselgriffe, um dadurch eine höhere Drehkraft zu erzeugen.

Ne mettez jamais de tubes ou autres pièces auxiliaires sur les poignées des clés à douille dans le but d'obtenir un couple de serrage plus élevé.

Extension Bars / Verlängerungen / Rallonges

The combination of several short extensions instead of one correct sized one is to be avoided.

Das Zusammenstecken von mehreren kurzen Verlängerungen als Ersatz für eine in der richtigen Länge ist unbedingt zu vermeiden.

Il faut absolument éviter d'utiliser plusieurs rallonges courtes au lieu d'une seule ayant la bonne longueur.

Adaptors / Verbindungsstücke / Réducteurs

Adaptors are to be used reasonably. Be reminded that high torque potentials are reached when using a "down" adaptor, a bigger sized handle to a smaller drive socket. Always stay within safe limits.

Reduzierstücke sind mit Vernunft einzusetzen. Beachten Sie, dass bei der Verwendung von Reduzierstücken hohe Drehmomentwerte ausgelöst werden nämlich dadurch, dass grössere Griffe auf kleinere Steckschlüssel gesetzt werden. Bleiben Sie jeweils innerhalb der Sicherheitsgrenzen.

Les réducteurs doivent être utilisés avec modération. Il est à considérer qu'avec les réducteurs on obtient un couple de serrage élevé du fait que des poignées plus grandes sont appliquées sur des clés à douille plus petites. Ne dépassez pas les limites de sécurité.

**Z-SERIES
Z-SERIE
SERIES-Z**



Koken Z-series



Z series - Evolution of Automotive service Lineup

Z-series MOVIE

- CONCEPT -

Continued advancements in engine designs and structures are producing engines that are more complex and compact. Work environments are being transformed to cater towards increased demands on auto mechanics.

We at Ko-ken TOOL CO., LTD., specialists in socket wrench manufacturing, have been committed to the development of automotive tools that are more suitable by pouring in our passion for perfecting hand tools and utilizing our experience obtained through over half a century of manufacturing to create the Z series.

“Z” stands for “zeal”. Through their unequalled performance, Z-Series tools are certain to become the mechanic’s new standard for the next generation of automotive tools.

- Konzept -

Der ständige Fortschritt im Motorenbau führt zu immer komplexeren und kompakteren Motoren.

Die Arbeitsmittel für den Automechaniker sollten auf diese neuen Anforderungen ausgerichtet sein.

Wir, Ko-ken TOOL CO., LTD. als Spezialisten in der Herstellung von Steckschlüsseln, fühlen uns im besonderen Masse verpflichtet Werkzeuge zur Verfügung zu stellen, die diesen ständig veränderten Anforderungen gerecht werden.

Unsere langjährige Erfahrung und unser absoluter Wille zur Perfektion halfen uns bei der Entwicklung der neuen Z-Serie.

Das „Z“ steht hier für das englische Wort ZEAL (Begeisterung).

Durch ihre beispiellose Leistung werden die Werkzeuge der Z-Serie zum neuen Standard der nächsten Generation von KFZ-Werkzeugen.

- Concept -

L'évolution continue des moteurs en matière de performance et design fait qu'ils deviennent de plus en plus complexes et compacts.

De ce fait, l'environnement de travail du mécanicien doit être adapté.

Chez Ko-ken TOOL CO., LTD., spécialiste dans la fabrication des clés à douilles, nous nous sommes dévoués à optimiser le travail du mécanicien en lui fournissant le parfait outil. C'est avec l'expérience d'un demi-siècle dans la production de l'adaptation à la demande du marché que nous avons réussi à développer la série „Z“.

„Z“ vient du mot anglais „Zeal“, ce qui signifie enthousiasme. De manière inédite, les douilles de la série „Z“ deviendront le nouveau outil standard pour le mécanicien de demain.

- OVERALL - - Allgemein - - Généralités -



• Designed for best performance

The designs were thoroughly reviewed to produce the Z-series.

All items in this series are now more compact.

Foregoing standards, radical design concepts have been implemented in producing the Z series which enables maximum potential in all professional mechanics.

• Konzipiert für eine bessere Leistung

Das Design der Z-Serie wurde komplett überdacht. Alle Artikel dieser Serie sind im Allgemeinen kompakter als die herkömmlichen Steckschlüssel.

Zukunftsweisende Standards und innovative Designkonzepte sorgen für ein optimiertes Anwendungspotenzial für den professionellen Mechaniker.

• Élaborée pour une meilleure performance

Un nouveau design a été spécialement conçu pour la série Z. Tous les articles sont plus compacts par rapport aux douilles normales.

Un standard futuriste et une conception innovatrice garantissent un usage optimal au mécanicien professionnel.

• Tolerance – Square drive

Movement at the joint between a socket and a ratchet or other drive accessory has been accepted as unavoidable.

To reduce this movement, we thoroughly reviewed dimensional accuracy of all the joint parts of Z-Series, and any movement in the rotating direction has now been minimized through production technologies.

• Toleranz Antriebsvierkante

Das Spiel an den Verbindungsstellen zwischen Steckschlüssel und Knarre oder zwischen anderen Betätigungselementen wurde bisher als unvermeidbar angesehen.

Um dieses Spiel zu verringern wurden die Toleranzen aller möglichen Verbindungsstellen bei der Z-Serie verringert.

Durch besondere Produktionstechniken wurde erreicht, dass es nun kaum noch Spiel in der Rotationsachse der Verbindungen mehr gibt.

• Tolérance – carré entraînant

Depuis toujours le jeu inévitable lors du raccord entre la douille et le cliquet, ou tout autre accessoire, a été déclaré comme inévitable.

Pour réduire ce jeu, nous avons vérifié à fond l'exactitude des dimensions sur les raccords et grâce à notre technologie de production, les rotations possibles ont pu être minimisées pour la série „Z“.

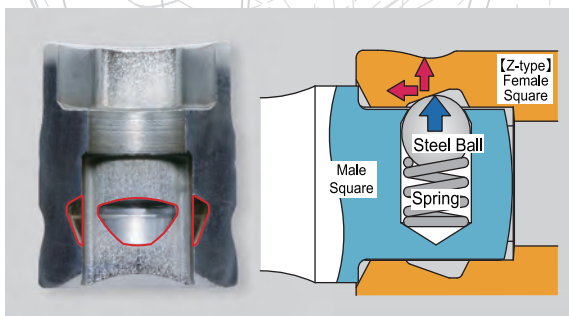
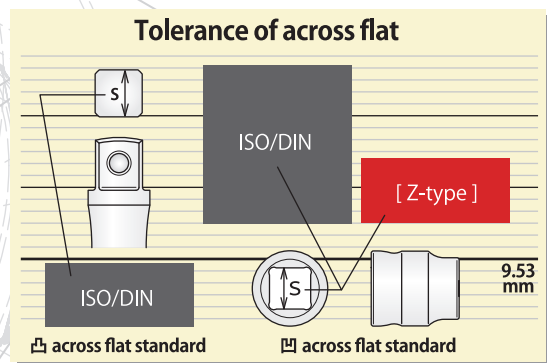

• Ball Holding Groove

The new Ball Holding Groove was installed. Any movement in the connecting direction has been reduced by a mechanism that pulls the parts together.

• Kugelfang

Die Werkzeuge der Z-Serie verfügen über spezielle Kugelfangrillen die eine noch sicherere Verbindung zwischen Betätigungswerkzeug und Steckschlüssel gewährleisten.

• Rainure pour bille

Un nouveau système de rainure pour bille a été installé. Tout mouvement dans le raccordement a été réduit par un mécanisme qui tire sur les parties raccordantes.

- REVERSIBLE RATCHET - - Knarre, verstellbar - - Cliquet, réversible -

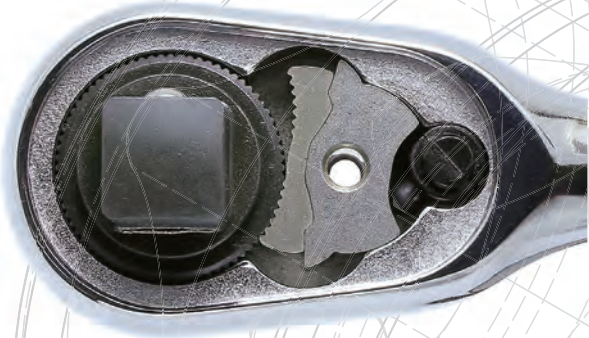

• 72 tooth gear Ratchet Handle - Light Ratchet Movement
This ratchet handle has a new mechanism for enhanced usability. This Ratchet has incredibly light turning torque that enables working on loosely tightened bolts.
With the compact head and balanced design, the Z-Series ratchet has evolved into what can be called the "ideal ratchet handle".

• Leichtgängiger 72 Zahn Knarren Mechanismus
Diese Knarre verfügt über ein neues, sehr leichtgängige Getriebe mit 72 Zähnen. Nach dem Lösen der Schraube genügt meist deren Gewindereibung um den Mechanismus der Knarre auszulösen.
Das ausgeglichene Design und der kompakte Knarrenkopf machen die Knarren der Z-Serie zur idealen Knarre.

• Cliquet à manche à 72 dents – cliquet à mouvement facile
Ce cliquet dispose d'un mécanisme à 72 dents permettant un usage élargi dû au mouvement facile du cliquet.
Pour nous, les cliquets de la série „Z“ avec leurs têtes compactes et le design équilibré, sont les „cliquets à manche idéaux“.

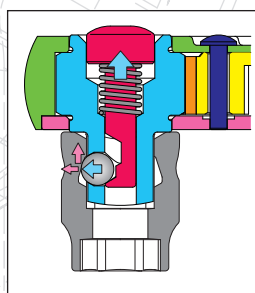
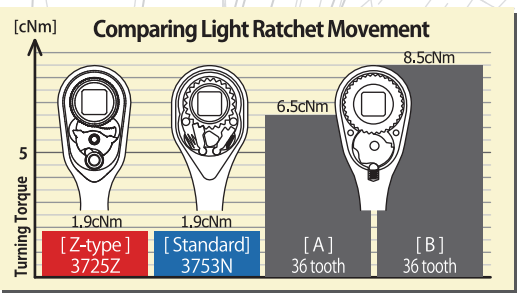

• Push release : Locking type
Innovative new locking mechanism is installed. This new mechanism achieved both of locking a socket and also unique feature of Z-series pulls parts together for tight connection.

• Knarre verstellbar mit Entriegelungsknopf
Der neue Mechanismus sorgt sowohl für einen sicheren Halt, als auch für einen fast spielfreien Sitz des Steckschlüssels auf dem Antriebsvierkant. Dies ist einzigartig bei der Z-Serie.

• Manche du cliquet
Le nouveau mécanisme assure un maintien sûr des douilles ainsi qu'un verrouillage presque sans jeu sur l'entraînement carré, une caractéristique unique de la série Z.

A, B : Other brand



- SOCKETS - - Steckschlüssel - - Douilles -

- Compact**
The length and diameter of sockets have been significantly reduced. Ideal for working in confined and tight areas.
- Kompakt**
Die Gesamtlänge und der Aussendurchmesser der Steckschlüssel wurden stark reduziert, dies erlaubt ein Arbeiten an schwer zugänglichen Stellen.
- Compact**
La longueur intégrale et le diamètre des douilles sont remarquablement réduits, ce qui permet de travailler dans des endroits étroits ou difficilement accessibles.

- Comparison of 10mm Sockets -

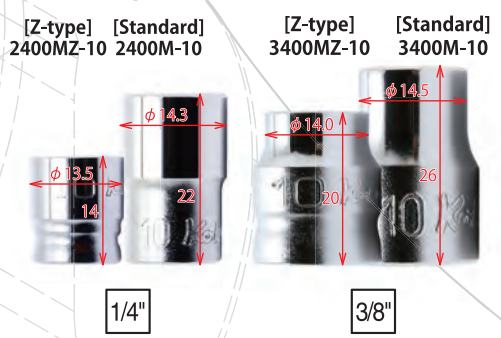

• Tolerance -Hexagon Opening.
Foregoing the ISO and DIN standards, radical design concepts have been implemented in producing the Z series which enables maximum potential in all professional mechanics.

• Toleranzen der 6-kant Öffnungen
Bewährte Standards nach (DIN und ISO) einhaltend und innovative Design Konzepte sorgen für ein optimiertes Anwendungspotenzial für den professionellen Mechaniker.

• Tolérances des ouvertures hexagonales
Un standard préalable (ISO et DIN) et une conception innovante sont implantés dans la production des produits „Z“ pour en sortir un potentiel de travail maximal pour le mécanicien professionnel.

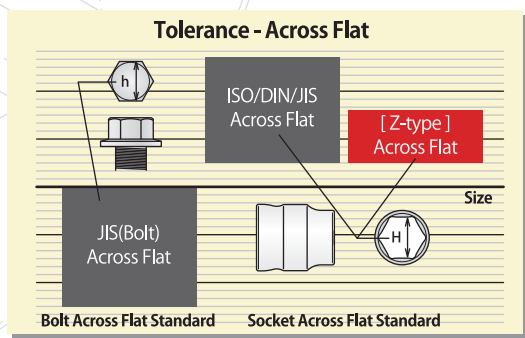

2400MZ



6-point Sockets
6-kant Steckschlüssel
Douilles 6-pans

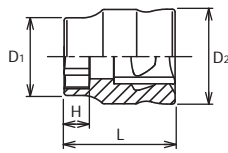

2400MZ (mm)	D ₁ (mm)	D ₂ (mm)	H (mm)	L (mm)	(g)	(pcs.)
4	6.4	11	3	14	6	10
4.5	7	11	3	14	6	10
5	7.6	11	3	14	6	10
5.5	8.2	11	3.5	14	6	10
6	8.8	11	3.5	14	6	10
7	9.9	11	3.5	14	6	10
8	11.1	11.7	4.5	15	7	10
10	13.5	12.5	7	15	8	10
11	14.7	13.2	7	15	9	10
12	15.9	14.4	7	15	11	10
13	17.1	15.6	7	15	14	10
14	18.3	16.8	7	15	16	10

RS2400MZ/12



Socket Set on magnetic Rail
Steckschlüsselsatz auf Magnetschiene
Jeu de douilles sur rail à aimant



RS2400MZ/12	12 Pieces Set/Rail 200mm	(g)
4, 4.5, 5, 5.5, 6, 7, 8, 10, 11, 12, 13, 14		228

2300XZ



6-point Sockets, Semi-Deep
6-kant Steckschlüssel, mittel-lang
Douilles, semi-profondes 6-pans

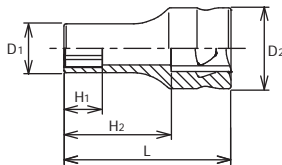

2300XZ (mm)	D ₁ (mm)	D ₂ (mm)	H ₁ (mm)	H ₂ (mm)	L (mm)	(g)	(pcs.)
5.5	8.2	11	6	20	30	10	10
6	8.8	11	7	20	30	10	10
7	9.9	11	8	20	30	11	10
8	11.1	11.7	9	20	30	13	10
10	13.5	12.5	11	20	30	16	10
11	14.7	13.2	12	20	30	19	10
12	15.9	14.4	13	20	30	22	10
13	17.1	15.6	14	20	30	26	10
14	18.3	16.8	14	20	30	30	10

RS2300XZ/9



Socket Set on magnetic Rail
Steckschlüsselsatz auf Magnetschiene
Jeu de douilles sur rail à aimant



RS2300XZ/9	9 Pieces Set/Rail 200mm	(g)
5.5, 6, 7, 8, 10, 11, 12, 13, 14		290

2300MZ



6-point Deep Sockets
6-kant-Steckschlüssel, lang
Douilles longues 6-pans

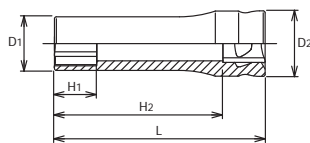

2300MZ (mm)	D ₁ (mm)	D ₂ (mm)	H ₁ (mm)	H ₂ (mm)	L (mm)	(g)	(pcs.)
4	6.4	11	5	41	50	14	10
4.5	7	11	5.5	41	50	16	10
5	7.6	11	6	41	50	16	10
5.5	8.2	11	6.5	41	50	16	10
6	8.8	11	7	41	50	17	10
7	9.9	11	8	41	50	20	10
8	11.1	11.7	9	41	50	22	10
10	13.5	12.5	11	41	50	29	10
11	14.7	13.2	12	41	50	33	10
12	15.9	14.4	13	41	50	40	10
13	17.1	15.6	14	41	50	45	10
14	18.3	16.8	16	41	50	51	10

RS2300MZ/12



Socket Set on magnetic Rail
Steckschlüsselsatz auf Magnetschiene
Jeu de douilles sur rail à aimant



RS2300MZ/12	12 Pieces Set/Rail 200mm	(g)
4, 4.5, 5, 5.5, 6, 7, 8, 10, 11, 12, 13, 14		445

	2441MZ (mm)	D ₁ (mm)	D ₂ (mm)	H (mm)	L (mm)	(g)	(pcs.)
New	8	12.3	11.7	4.5	30.5	18	10
New	10	14.3	11.7	4.5	30.5	20	10
New	12	16.8	11.7	5.5	31.5	25	10
New	13	18	11.7	5.5	31.5	27	10
New	14	20	11.7	7	33	31	10



2441MZ  Nut Grip Universal Sockets **Nut Grip®**
Gelenk-Einsätze mit zweifacher Kugelhalterung
Douilles articulées à billes de retenue

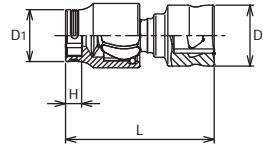

	2000Z-28 (PH)	D (mm)	H (mm)	L (mm)	(g)	(pcs.)
	1	11.2	12	28	9	10
	2	11.2	12	28	10	10
	3	11.2	12	28	10	10

	2000Z-50 (PH)	D (mm)	d (mm)	H (mm)	L (mm)	(g)	(pcs.)
	1	11.2	4	34	50	11	10
	2	11.2	5	34	50	13	10
	3	11.2	-	34	50	16	10

2000Z-28 / -50  PH Bit Sockets
Steckschlüssel für Kreuzschlitzschrauben, PH
Douilles tournevis pour vis à empreinte PH

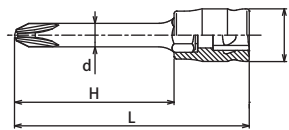

	2005Z-25	T x W (mm)	D (mm)	H (mm)	L (mm)	(g)	(pcs.)
	5	1.0 x 5.5	11.2	9	25	9	10
	6	1.2 x 6.5	11.2	9	25	10	10

2005Z-25  Bit Sockets for Slotted Head
Steckschlüssel für Schlitzschrauben
Douilles tournevis pour vis à fente

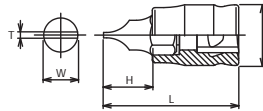

	2010MZ-25 (mm)	D (mm)	H (mm)	L (mm)	(g)	(pcs.)
	3	11.2	9	25	9	10
	4	11.2	9	25	9	10
	5	11.2	9	25	10	10
	6	11.2	9	25	10	10

2010MZ-25 / -50  Inhex Bit Sockets
Steckschlüssel für Innensechskant-Schrauben
Douilles tournevis pour vis 6-pans creux

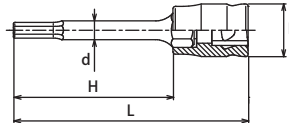

	2010MZ-50 (mm)	D (mm)	d (mm)	H (mm)	L (mm)	(g)	(pcs.)
	3	11.2	4	34	50	11	10
	4	11.2	5	34	50	13	10
	5	11.2	6	34	50	15	10
	6	11.2	-	34	50	17	10

RS20XXZ/9		9 Pieces Set/Rail 200mm	(g)
2000Z.28		1, 2, 3	213
2005Z.25		5, 6	
2010MZ.25		3, 4, 5, 6	

RS20XXZ/9 

Socket Set on magnetic Rail
Steckschlüsselsatz auf Magnetschiene
Jeu de douilles sur rail à aimant



Z-SERIES
HAND
TITANIUM
SCREWDRIVERS
ACCESSORIES
IMPACT
SLEEVE-DRIVE
PROTECTOR
INDUSTRIAL
AUTOMOTIVE
MOTORCYCLE
CONSTRUCTION
SPARE PART

2025Z-28 / -50



TORX® Bit Sockets
TORX® Bit-Steckschlüssel
Douilles tournevis, TORX®

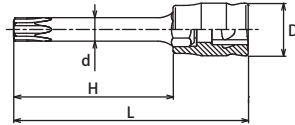

2025Z-28 (T)	D (mm)	H (mm)	L (mm)	(g)	(pcs.)
T10	11.2	12	28	9	10
T15	11.2	12	28	9	10
T20	11.2	12	28	9	10
T25	11.2	12	28	10	10
T27	11.2	12	28	10	10
T30	11.2	12	28	10	10
T40	11.2	12	28	11	10

2025Z-50 (T)	D (mm)	d (mm)	H (mm)	L (mm)	(g)	(pcs.)
T10	11.2	4	34	50	11	10
T15	11.2	4	34	50	11	10
T20	11.2	4.5	34	50	12	10
T25	11.2	5	34	50	13	10
T27	11.2	5	34	50	13	10
T30	11.2	5.6	34	50	15	10
T40	11.2	-	34	50	17	10

RS2025Z/7-L28 RS2025Z/7-L50



Socket Set on magnetic Rail
Steckschlüsselsatz auf Magnetschiene
Jeu de douilles sur rail à aimant



RS2025Z/7-L28	7 Pieces Set/Rail 200mm	(g)
T10, T15, T20, T25, T27, T30, T40		195

RS2025Z/7-L50	7 Pieces Set/Rail 200mm	(g)
T10, T15, T20, T25, T27, T30, T40		220

2725Z

Reversible Ratchet
Knarre, verstellbar
Cliquet, réversible

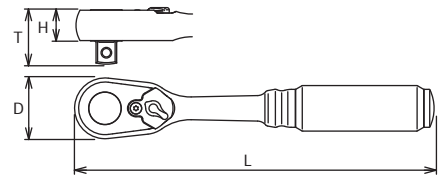

2725Z	D (mm)	T (mm)	H (mm)	L (mm)	(g)	(pce.)
	20.5	17.1	9.5	114	79	1

* Renewal Kits → 2725RK-2 → P320

2725Z-160

Reversible Ratchet
Knarre, verstellbar
Cliquet, réversible

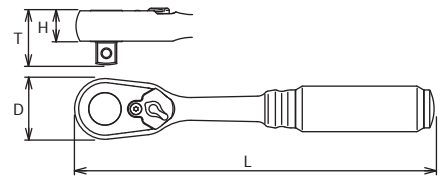

2725Z-160	D (mm)	T (mm)	H (mm)	L (mm)	(g)	(pce.)
	20.5	17.1	9.5	160	115	1

* Renewal Kits → 2725RK-2 → P320

⚠ 2725Z-160 have longer handle than standard, and can be loaded to excessive torque value. In the interest of your own safety always apply load evenly and progressively to avoid breakage and possible injury.

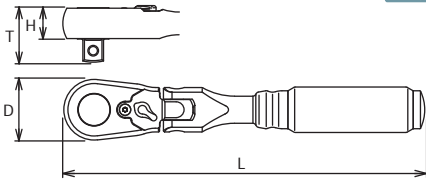

	D (mm)	T (mm)	H (mm)	L (mm)	(g)	(pce.)
2726Z	20.5	17.1	9.5	114	103	1

* Renewal Kits → 2725RK-2 → P320

2726Z Flexible Ratchet, Reversible (Short)
Gelenk-Knarre kurz, verstellbar
Cliquet articulé court, réversible

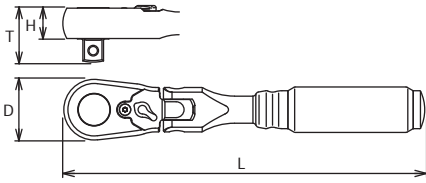

	D (mm)	T (mm)	H (mm)	L (mm)	(g)	(pce.)
2726Z-160	20.5	17.1	9.5	160	125	1

* Renewal Kits → 2725RK-2 → P320

2726Z-160 Flexible Ratchet, Reversible (long) ⚠
Gelenk-Knarre lang, verstellbar
Cliquet articulé long, réversible



⚠ 2726Z-160 have longer handle than standard, and can be loaded to excessive torque value. In the interest of your own safety always apply load evenly and progressively to avoid breakage and possible injury.



2760Z

Extension Bars
Verlängerungen
Rallonges

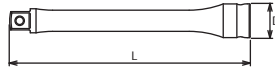

	D (mm)	L (mm)	(g)	(pcs.)
2760Z-50	11.5	50	21	10
2760Z-100	11.5	100	39	10
2760Z-150	11.5	150	58	10

2771Z

Universal Joint
Gelenk-Einsatz
Joint articulé



UNIVERSAL JOINT

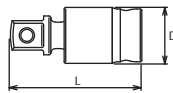

	D (mm)	L (mm)	(g)	(pcs.)
2771Z	11.7	29.9	15	10

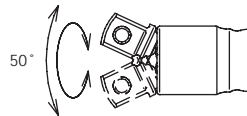

2772Z

Universal Double Joint
Doppelgelenk-Einsatz
Joint articulé double

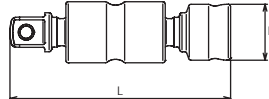

	D (mm)	L (mm)	(g)	(pcs.)
2772Z	11.7	46	26	10

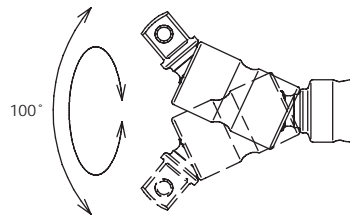

2756Z

Quick Spinner
Rändel-Drehscheibe
Lanceur



	D (mm)	L (mm)	(g)	(pcs.)
2756Z	20.3	18	15	10

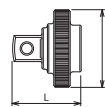

2756Z-3/8

2756Z-1/2

Quick Spinner, Adaptor
Rändel-Drehscheibe als Adaptor
Lanceur, adaptateur



2756Z-3/8

2756Z-1/2



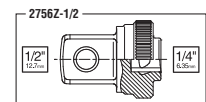
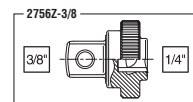
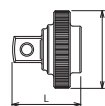





	D (mm)	L (mm)	(g)	(pcs.)
2756Z-3/8	20.3	21.5	24	10
2756Z-1/2	20.3	26	35	10



1/4"







Z-series
Z-serie
Series-Z

Z-SERIES
HAND
TITANIUM
ACCESSORIES
SCREWDRIVERS
IMPACT
SLEEVE-DRIVE
PROTECTOR
INDUSTRIAL
AUTOMOTIVE
MOTORCYCLE
CONSTRUCTION
SPARE PART

P2285Z		26 Pieces Set/△=660g	
PLASTIC CASE:W245xH120xT45			
Sockets	Accessories		
 2400MZ 6-pt. Sockets 4, 4.5, 5, 5.5, 6, 7, 8, 10, 11, 12, 13, 14	 2725Z	 2756Z	 2771Z
 2000Z.28 1, 2, 3	 2760Z-50		
 2005Z.25 5, 6	 2760Z-150		
 2010MZ.25 3, 4, 5, 6			



P2285Z Set in PE-foam tray
Steckschlüsselsatz in Weichschaumeinlage
Set disposé dans boîte de rangement en mousse souple



2286Z		17 Pieces Set/△=780g	
BLACK METAL CASE:W240xH100xT32mm			
Sockets	Accessories		
 2400MZ 6-pt. Sockets 4, 5, 5.5, 6, 7, 8, 10, 11, 12, 13, 14	 2725Z	 2756Z	 2771Z
	 2760Z-50		
	 2760Z-100		
	 2760Z-150		

2286Z Set in PE-foam tray
Steckschlüsselsatz in Weichschaumeinlage
Set disposé dans boîte de rangement en mousse souple



2285ZE		10 Pieces Set/△=300g	
Rail 200mm/PLASTIC BAG			
Sockets	Accessories		
 2400MZ 6-pt. Sockets 5.5, 6, 7, 8, 10, 12, 13, 14	 2725Z		
	 2756Z		

2285ZE Socket Sets
Steckschlüssel Sätze
Jeu de clés à douilles



3400MZ

6-point Sockets
6-kant Steckschlüssel
Douilles 6-pans

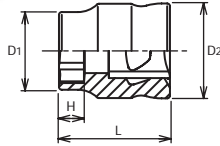

3400MZ (mm)	D ₁ (mm)	D ₂ (mm)	H (mm)	L (mm)	(g)	(pcs.)
5.5	8.5	17	3.5	19	16	10
6	9.1	17	3.5	19	17	10
7	10.3	17	3.5	19	17	10
8	11.5	17	4.5	20	17	10
10	14	17	4.5	20	18	10
11	15.3	17	5.5	21	18	10
12	16.5	17	5.5	21	19	10
13	17.8	17	8.5	21	19	10
14	19	17	8.5	21	20	10
15	20.2	18.2	8.5	21	24	10
16	21.3	19.3	8.5	21	28	10
17	22.5	20.5	8.5	21	32	10
18	23.6	21.6	9.5	22	38	10
19	24.8	22.8	9.5	22	41	10
21	27	25	10.5	23	51	10
22	28.3	26.3	10.5	23	58	10

3400MZ is designed 5-9mm shorter than standard 3400M.
Ideal for working in confined and tight areas.

RS3400MZ/8 RS3400MZ/12

Socket Set on magnetic Rail
Steckschlüsselsatz auf Magnetschiene
Jeu de douilles sur rail à aimant



RS3400MZ/8	8 Pieces Set/Rail 200mm	(g)
8, 10, 11, 12, 13, 14, 17, 19		320

RS3400MZ/12	12 Pieces Set/Rail 300mm	(g)
7, 8, 10, 11, 12, 13, 14, 15, 16, 17, 18, 19		490

3300XZ

6-point Sockets, Semi-Deep
6-kant Steckschlüssel, mittel-lang
Douilles, semi-profondes 6-pans

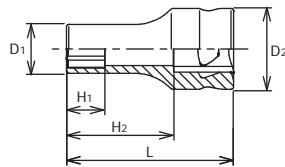

3300XZ (mm)	D ₁ (mm)	D ₂ (mm)	H ₁ (mm)	H ₂ (mm)	L (mm)	(g)	(pcs.)
7	10.3	17	8	23	35	23	10
8	11.5	17	9	23	35	24	10
10	14	17	11	23	35	26	10
11	15.3	17	12	23	35	28	10
12	16.5	17	13	23	35	29	10
13	17.8	17	14	23	35	32	10
14	19	17	16	23	35	34	10
15	20.2	18.2	16	23	35	40	10
16	21.3	19.3	16.5	23	35	45	10
17	22.5	20.5	16.5	23	35	50	10
18	23.6	21.6	16.5	23	35	56	10
19	24.8	22.8	18	23	35	60	10

RS3300XZ/8 RS3300XZ/12

Socket Set on magnetic Rail
Steckschlüsselsatz auf Magnetschiene
Jeu de douilles sur rail à aimant



RS3300XZ/8	8 Pieces Set/Rail 200mm	(g)
8, 10, 11, 12, 13, 14, 17, 19		420

RS3300XZ/12	12 Pieces Set/Rail 300mm	(g)
7, 8, 10, 11, 12, 13, 14, 15, 16, 17, 18, 19		630

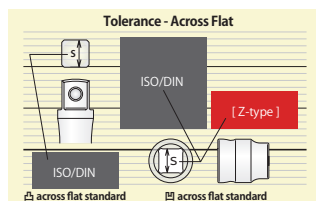
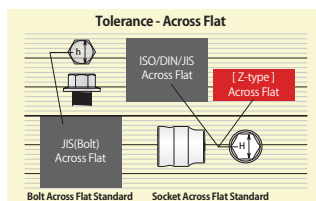

Manufacturing tolerance is precisely controlled to achieve a secure fitting.

BALL HOLDING GROOVE

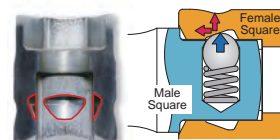

The inventive Ball Holding system of the Z-series allows a secure connection between Socket and Handle.

Die Werkzeuge der Z-Serie verfügen über spezielle Kugelfangrillen, die eine noch sicherere Verbindung zwischen Betätigungswerkzeug und Steckschlüssel gewährleisten.

La série Z dispose d'une rainure de fixation pour bille spéciale, qui améliore nettement la fixation entre douille et cliquet.

3300MZ (mm)	D ₁ (mm)	D ₂ (mm)	H ₁ (mm)	H ₂ (mm)	L (mm)	(g)	(pcs.)
7	10.3	17	8	41.5	55	29	10
8	11.5	17	9	41.5	55	34	10
10	14	17	11	41.5	55	43	10
11	15.3	17	12	41.5	55	45	10
12	16.5	17	13	41.5	55	49	10
13	17.8	17	14	41.5	55	52	10
14	19	17	16	41.5	55	55	10
15	20.2	18.2	16	40.5	55	65	10
16	21.3	19.3	17	40.5	55	74	10
17	22.5	20.5	18	40.5	55	83	10
18	23.6	21.6	19	39.5	55	90	10
19	24.8	22.8	20	39.5	55	95	10



3300MZ 6-point Deep Sockets
6-kant-Steckschlüssel, lang
Douilles longues 6-pans

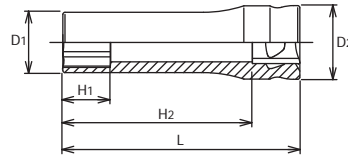

RS3300MZ/8	8 Pieces Set/Rail 200mm	(g)
8, 10, 11, 12, 13, 14, 17, 19		600

RS3300MZ/12	12 Pieces Set/Rail 300mm	(g)
7, 8, 10, 11, 12, 13, 14, 15, 16, 17, 18, 19		900

RS3300MZ/8 Socket Set on magnetic Rail
Steckschlüsselsatz auf Magnetschiene
Jeu de douilles sur rail à aimant

RS3300MZ/12



RS3X00MZ/12	12 Pieces Set/Rail 300mm	(g)
3400MZ	8, 10, 11, 12, 13, 14, 17, 19	550
3300MZ	8, 10, 12, 14	

RS3X00MZ/12 Socket Set on magnetic Rail
Steckschlüsselsatz auf Magnetschiene
Jeu de douilles sur rail à aimant



3300CZ (mm)	D (mm)	H ₁ (mm)	H ₂ (mm)	L (mm)	(g)	(pcs.)
14	18.4	11	17	70	67	10
16	20.5	13	17	70	71	10
18	22.9	12	17	70	75	10
20.8	26.3	13.5	17	70	105	10

Slim & light weight body with smaller outside diameter for work in tight spaces.

Spring clip type spark plug sockets caused deforming the clip if it would be used with shallow engagement.



3300CZ Spark Plug Sockets with Spring Clips
Zündkerzen-Schlüssel mit Haltefeder
Douilles avec ressorts de retenues pour bougies

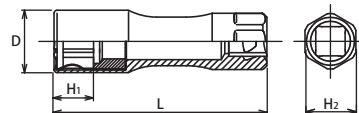

3305PZ (mm)	D (mm)	H ₁ (mm)	H ₂ (mm)	L (mm)	(g)	(pcs.)
14	17.9	8	17	70	56	10
16	20	8	17	70	55	10

Spark Plug Socket with Magnet, 12-pt. opening: size 14mm



The magnet could be broken with any impacts. Please handle with care.

3305PZ Spark Plug Socket with Magnet, 12-pt. opening
Zündkerzensteckschlüssel mit Magnet, 12-kant
Douille pour bougies, avec aimant, 12-pans

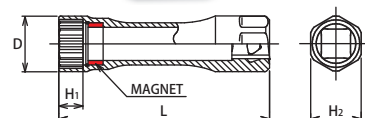

Z-SERIES
HAND
TITANIUM
SCREWDRIVERS
ACCESSORIES
IMPACT
SLEEVE-DRIVE
PROTECTOR
INDUSTRIAL
AUTOMOTIVE
MOTORCYCLE
CONSTRUCTION
SPARE PART

3441MZ



Nut Grip Universal Sockets **Nut Grip®**
Gelenk-Einsätze mit zweifacher Kugelhalterung
Douilles articulées à billes de retenue

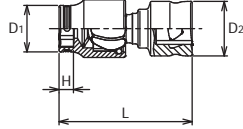

	3441MZ (mm)	D ₁ (mm)	D ₂ (mm)	H (mm)	L (mm)	(g)	(pcs.)
New	8	12	17	4.5	41.5	45	10
New	10	14.5	17	4.5	41.5	47	10
New	12	16.8	17	5.5	42.5	50	10
New	13	17.8	17	5.5	42.5	53	10
New	14	19.5	17	7	44	55	10
New	17	23.4	17	8.5	45.5	66	10

3010MZ-50 / -75



Inhex Bit Sockets
Steckschlüssel für Innensechskant-Schrauben
Douilles tournevis pour vis 6-pans creux

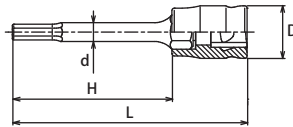

	3010MZ-50 (mm)	D (mm)	d (mm)	H (mm)	L (mm)	(g)	(pcs.)
	3	17	4	23.5	50	28	10
	4	17	5	23.5	50	29	10
	5	17	6	23.5	50	30	10
	6	17	7	23.5	50	35	10
	7	17	-	23.5	50	38	10
	8	17	-	23.5	50	40	10
	10	17	-	23.5	50	50	10
	12	19	-	23.5	50	70	10

	3010MZ-75 (mm)	D (mm)	d (mm)	H (mm)	L (mm)	(g)	(pcs.)
	3	17	6	48.5	75	33	10
	4	17	6	48.5	75	35	10
	5	17	6	48.5	75	36	10
	6	17	7	48.5	75	41	10
	7	17	7.9	48.5	75	45	10
	8	17	-	48.5	75	48	10
	10	17	-	48.5	75	65	10
	12	19	-	48.5	75	90	10

RS3010MZ/8-L50 RS3010MZ/8-L75



Socket Set on magnetic Rail
Steckschlüsselsatz auf Magnetschiene
Jeu de douilles sur rail à aimant



RS3010MZ/8-L50	8 Pieces Set/Rail 200mm	(g)
3, 4, 5, 6, 7, 8, 10, 12		460

RS3010MZ/8-L75	8 Pieces Set/Rail 200mm	(g)
3, 4, 5, 6, 7, 8, 10, 12		530

3025Z-50 / -75



TORX® Bit Sockets
TORX® Bit-Steckschlüssel
Douilles tournevis, TORX®

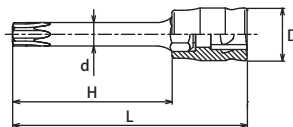

	3025Z-50 (T)	D (mm)	d (mm)	H (mm)	L (mm)	(g)	(pcs.)
	T10	17	3	23.5	50	27	10
	T15	17	3.5	23.5	50	28	10
	T20	17	3.9	23.5	50	28	10
	T25	17	4.5	23.5	50	29	10
	T27	17	5	23.5	50	30	10
	T30	17	5.6	23.5	50	31	10
	T40	17	6.7	23.5	50	35	10
	T45	17	7.83	23.5	50	38	10
	T50	17	8.90	23.5	50	48	10
	T55	19	11.3	23.5	50	70	10

	3025Z-75 (T)	D (mm)	d (mm)	H (mm)	L (mm)	(g)	(pcs.)
	T20	17	4.5	48.5	75	32	10
	T25	17	5	48.5	75	33	10
	T27	17	5	48.5	75	33	10
	T30	17	5.6	48.5	75	35	10
	T40	17	6.7	48.5	75	41	10
	T45	17	7.9	48.5	75	45	10
	T50	17	8.9	48.5	75	55	10
	T55	19	11.3	48.5	75	80	10

RS3025Z/8-L50 RS3025Z/8-L75



Socket Set on magnetic Rail
Steckschlüsselsatz auf Magnetschiene
Jeu de douilles sur rail à aimant



RS3025Z/8-L50	8 Pieces Set/Rail 200mm	(g)
T20, T25, T27, T30, T40, T45, T50, T55		450

RS3025Z/8-L75	8 Pieces Set/Rail 200mm	(g)
T20, T25, T27, T30, T40, T45, T50, T55		480

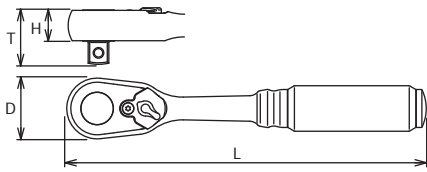

72

	D (mm)	T (mm)	H (mm)	L (mm)	(g)	(pce.)
2725Z-3/8	20.5	20.5	9.5	114	83	1

* Renewal Kits → 2725RK-2(3/8) → P320

2725Z-3/8

Reversible Ratchet Short
Knarre kurz, verstellbar
Cliquet court, réversible

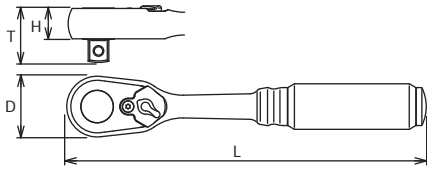

72

	D (mm)	T (mm)	H (mm)	L (mm)	(g)	(pce.)
2725Z-3/8 (L160)	20.5	20.5	9.5	160	120	1

* Renewal Kits → 2725RK-2(3/8) → P320

⚠ 2725Z-3/8 (L160) have longer handle than standard, and can be loaded to excessive torque value. In the interest of your own safety always apply load evenly and progressively to avoid breakage and possible injury.

2725Z-3/8 (L160)

Reversible Ratchet (long)
Knarre lang, verstellbar
Cliquet long, réversible ⚠

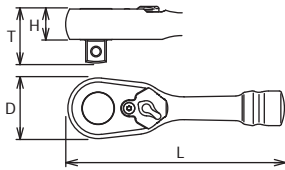

72

	D (mm)	T (mm)	H (mm)	L (mm)	(g)	(pce.)
3725ZS	28	24.5	13.7	100	157	1

* Renewal Kits → 3725RK-2 → P320

3725ZS

Reversible Ratchet Short
Knarre kurz, verstellbar
Cliquet court, réversible

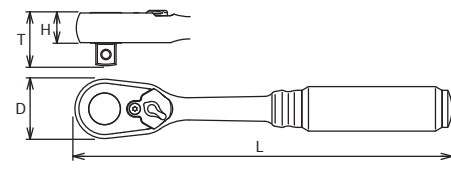

72

	D (mm)	T (mm)	H (mm)	L (mm)	(g)	(pce.)
3725Z	28	24.5	13.7	178	236	1

* Renewal Kits → 3725RK-2 → P320

3725Z

Reversible Ratchet
Knarre, verstellbar
Cliquet, réversible



72



3725Z-280

Reversible Ratchet (long)
Knarre lang, verstellbar
Cliquet long, réversible ⚠

	D (mm)	T (mm)	H (mm)	L (mm)	(g)	(pce.)
3725Z-280	28	24.5	13.7	280	360	1

* Renewal Kits → 3725RK-2 → P320

⚠ 3725Z-280 have longer handle than standard, and can be loaded to excessive torque value. In the interest of your own safety always apply load evenly and progressively to avoid breakage and possible injury.

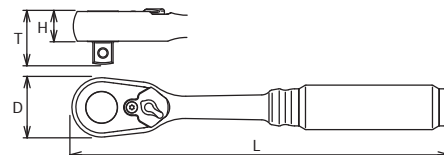

2725ZB-3/8

Reversible Ratchet with Quick Release Button
Knarre, verstellbar mit Entriegelungsknopf
Cliquet, réversible avec bouton de débrayage



	D (mm)	T (mm)	H (mm)	L (mm)	(g)	(pce.)
New 2725ZB-3/8	20.5	20.5	9.5	114	83	1

* Renewal Kits → 2725BRK-1(3/8) → P320

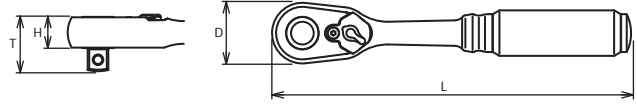

2725ZB-3/8 (L160)

Reversible Ratchet Long with Quick Release Button
Knarre lang, verstellbar mit Entriegelungsknopf
Cliquet long, réversible, avec bouton de déverrouillage



	D (mm)	T (mm)	H (mm)	L (mm)	(g)	(pce.)
New 2725ZB-3/8 (L160)	20.5	20.5	9.5	160	120	1

* Renewal Kits → 2725BRK-1(3/8) → P320

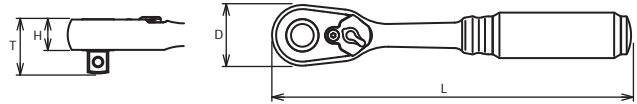

⚠ 2725ZB-3/8(L160) have longer handle than standard, and can be loaded to excessive torque value. In the interest of your own safety always apply load evenly and progressively to avoid breakage and possible injury.

3725ZSB

Reversible Ratchet Short with Quick Release Button
Knarre, verstellbar mit Entriegelungsknopf
Cliquet, réversible avec bouton de débrayage



	D (mm)	T (mm)	H (mm)	L (mm)	(g)	(pce.)
New 3725ZSB	28	24.5	13.7	100	157	1

* Renewal Kits → 3725BRK-1 → P320

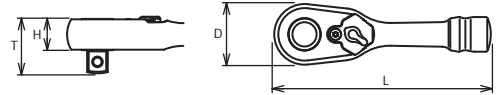

3725ZB

Reversible Ratchet with Quick Release Button
Knarre, verstellbar mit Entriegelungsknopf
Cliquet, réversible avec bouton de débrayage



	D (mm)	T (mm)	H (mm)	L (mm)	(g)	(pce.)
New 3725ZB	28	24.5	13.7	178	236	1

* Renewal Kits → 3725BRK-1 → P320

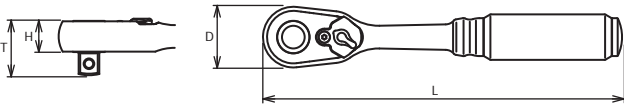

3725ZB-280

Reversible Ratchet Long with Quick Release Button
Knarre lang, verstellbar mit Entriegelungsknopf
Cliquet long, réversible, avec bouton de déverrouillage



	D (mm)	T (mm)	H (mm)	L (mm)	(g)	(pce.)
New 3725ZB-280	28	24.5	13.7	280	360	1

* Renewal Kits → 3725BRK-1 → P320

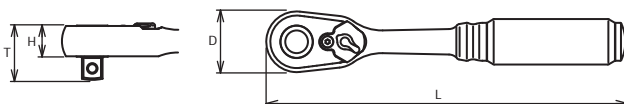

⚠ 3725ZB-280 have longer handle than standard, and can be loaded to excessive torque value. In the interest of your own safety always apply load evenly and progressively to avoid breakage and possible injury.

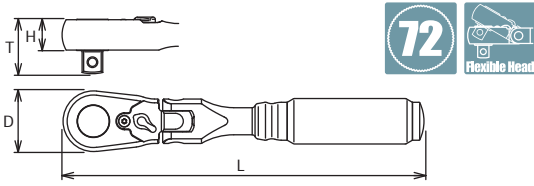

	D (mm)	T (mm)	H (mm)	L (mm)	(g)	(pce.)
2726Z-3/8	20.5	20.5	9.5	114	107	1

* Renewal Kits → 2725RK-2(3/8) → P320

2726Z-3/8

Flexible Ratchet, Reversible (Short)
Gelenk-Knarre kurz, verstellbar
Cliquet articulé court, réversible

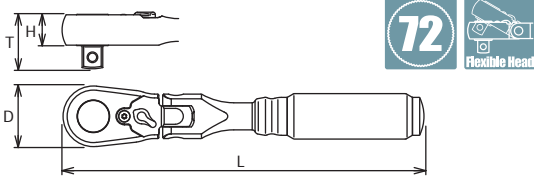

	D (mm)	T (mm)	H (mm)	L (mm)	(g)	(pce.)
2726Z-3/8 (L160)	20.5	20.5	9.5	160	130	1

* Renewal Kits → 2725RK-2(3/8) → P320

2726Z-3/8 (L160)

Flexible Ratchet long, Reversible
Gelenk-Knarre lang, verstellbar
Cliquet articulé long, réversible



2726Z-3/8 (L160) have longer handle than standard, and can be loaded to excessive torque value. In the interest of your own safety always apply load evenly and progressively to avoid breakage and possible injury.

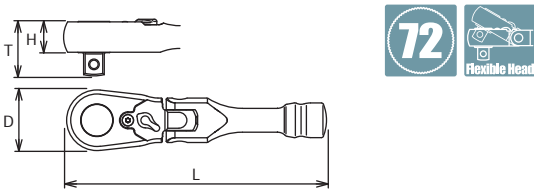

	D (mm)	T (mm)	H (mm)	L (mm)	(g)	(pce.)
3726ZS	28	24.5	13.7	120	196	1

* Renewal Kits → 3725RK-2 → P320

3726ZS

Flexible Ratchet, Reversible (Short)
Gelenk-Knarre kurz, verstellbar
Cliquet articulé court, réversible

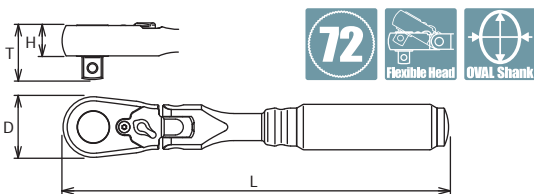

	D (mm)	T (mm)	H (mm)	L (mm)	(g)	(pce.)
3726Z	28	24.5	13.7	178	317	1

* Renewal Kits → 3725RK-2 → P320

3726Z

Flexible Ratchet, Reversible
Gelenk-Knarre, verstellbar
Cliquet articulé, réversible



	D (mm)	T (mm)	H (mm)	L (mm)	(g)	(pce.)
3726Z-280	28	24.5	13.7	280	420	1

* Renewal Kits → 3725RK-2 → P320

3726Z-280 have longer handle than standard, and can be loaded to excessive torque value. In the interest of your own safety always apply load evenly and progressively to avoid breakage and possible injury.

3726Z-280

Flexible Ratchet long, Reversible
Gelenk-Knarre lang, verstellbar
Cliquet articulé long, réversible

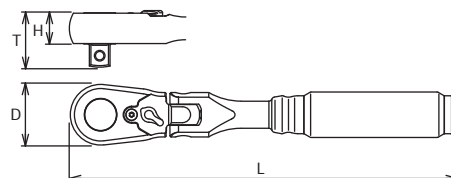

2726ZB-3/8

Flexible Ratchet, Reversible with Quick Release Button (Short)
Gelenk-Knarre, verstellbar mit Entriegelungsknopf
Cliquet, articulée, réversible avec bouton de débrayage



	D (mm)	T (mm)	H (mm)	L (mm)	(g)	(pce.)
New 2726ZB-3/8	20.5	20.5	9.5	114	107	1

* Renewal Kits → 2725BRK-1(3/8) → P320

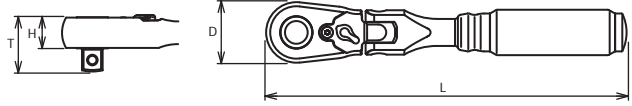

2726ZB-3/8 (L160)

Flexible Ratchet long, Reversible with Quick Release Button
Gelenk-Knarre lang, verstellbar mit Entriegelungsknopf
Cliquet long articulé, réversible avec bouton de débrayage



	D (mm)	T (mm)	H (mm)	L (mm)	(g)	(pce.)
New 2726ZB-3/8 (L160)	20.5	20.5	9.5	160	130	1

* Renewal Kits → 2725BRK-1(3/8) → P320

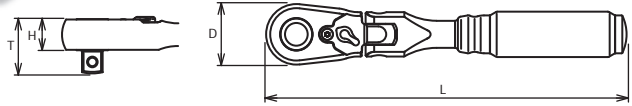

⚠ 2726ZB-3/8(L160) has longer handle than standard, and can be loaded to excessive torque value. In the interest of your own safety always apply load evenly and progressively to avoid breakage and possible injury.

3726ZSB

Flexible Ratchet, Reversible with Quick Release Button (Short)
Gelenk-Knarre, verstellbar mit Entriegelungsknopf
Cliquet, articulée, réversible avec bouton de débrayage



	D (mm)	T (mm)	H (mm)	L (mm)	(g)	(pce.)
New 3726ZSB	28	24.5	13.7	120	196	1

* Renewal Kits → 3725BRK-1 → P320

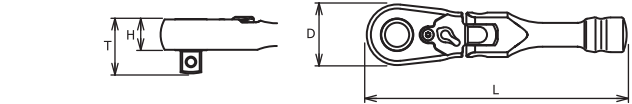

3726ZB

Flexible Ratchet, Reversible with Quick Release Button
Gelenk-Knarre lang, verstellbar mit Entriegelungsknopf
Cliquet, articulée, réversible avec bouton de débrayage

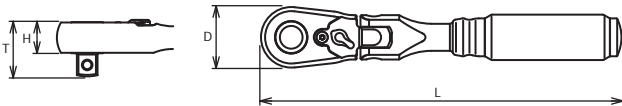

	D (mm)	T (mm)	H (mm)	L (mm)	(g)	(pce.)
New 3726ZB	28	24.5	13.7	178	317	1

* Renewal Kits → 3725BRK-1 → P320

3726ZB-280

Flexible Ratchet long, Reversible with Quick Release Button
Gelenk-Knarre lang, verstellbar mit Entriegelungsknopf
Cliquet long articulé, réversible avec bouton de débrayage

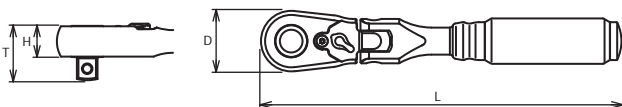

	D (mm)	T (mm)	H (mm)	L (mm)	(g)	(pce.)
New 3726ZB-280	28	24.5	13.7	280	420	1

* Renewal Kits → 3725BRK-1 → P320

⚠ 3726ZB-280 have longer handle than standard, and can be loaded to excessive torque value. In the interest of your own safety always apply load evenly and progressively to avoid breakage and possible injury.



3768Z-250 3768Z-400

Hinge Handle
Gelenkgriff
Poignée articulée



	D (mm)	L (mm)	(g)	(pcs.)
3768Z-250	20.5	250	309	5
3768Z-400	20.5	400	500	2

* Renewal Kits → 3768ZRK → P321

3768Z-400 have longer handle than standard, and can be loaded to excessive torque value. In the interest of your own safety always apply load evenly and progressively to avoid breakage and possible injury.

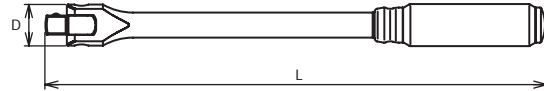

3760Z

Extension Bars
Verlängerungen
Rallonges



	D (mm)	L (mm)	(g)	(pcs.)
3760Z-75	17.5	75	66	10
3760Z-125	17.5	125	103	10
3760Z-250	17.5	250	195	5

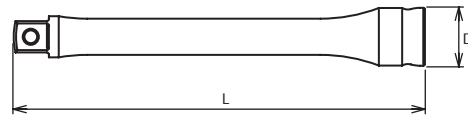

3760LZ

Locking Extension Bars
Verriegelbare Verlängerungen
Barres d'extension verrouillables

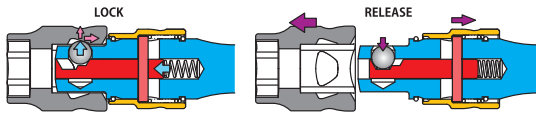

	D ₁ (mm)	D ₂ (mm)	L (mm)	(g)	(pcs.)
New 3760LZ-75	17.5	16.5	75	75	10
New 3760LZ-125	17.5	16.5	125	105	10
New 3760LZ-250	17.5	16.5	250	185	5

You may not hold the sliding part while moving to avoid heating up by friction and reduction by wear.

Bitte das gleitende Teil während der Bewegung nicht festhalten, um eine Erhitzung durch Reibung und durch Verschleiß zu vermeiden.

Veuillez ne pas tenir la pièce coulissante pendant le mouvement, afin d'éviter un échauffement dû à la friction et à l'usure.

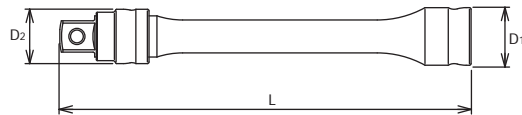

	D (mm)	L (mm)	(g)	(pcs.)
3771Z	18	42.5	44	10



3771Z

Universal Joint
Gelenk-Einsatz
Joint articulé

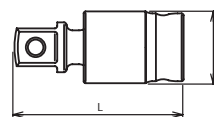
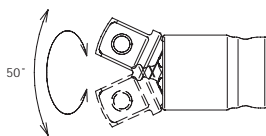

	D (mm)	L (mm)	(g)	(pcs.)
3772Z	17	65	76	10

3772Z

Universal Double Joint
Doppelgelenk-Einsatz
Joint articulé double

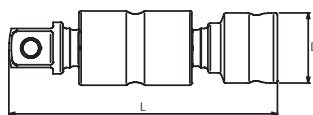
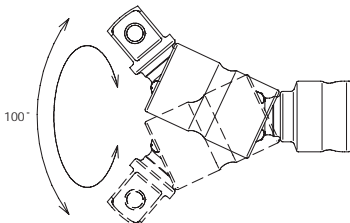

Z-series
Z-serie
Series-Z

3/8"

Z-SERIES
HAND
TITANIUM
SCREWDRIVERS
ACCESSORIES
IMPACT
SLEEVE-DRIVE
PROTECTOR
INDUSTRIAL
AUTOMOTIVE
CONSTRUCTION
MOTORCYCLE
SPARE PART

3756Z Quick Spinner
Rändel-Drehscheibe
Lanceur



	D (mm)	L (mm)	(g)	(pcs.)
3756Z	28	25	40	10

Outside diameter is smaller compared to standard 3756.
Ideal for working in combination with 3725Z.



3756ZS Quick Spinner
Rändel-Drehscheibe
Lanceur



	D (mm)	L (mm)	(g)	(pcs.)
3756ZS	20.3	25	26	10

Ideal for working in combination with 2725Z-3/8 and 2726Z-3/8.

3756Z-1/2 Quick Spinner, Adaptor
Rändel-Drehscheibe als Adaptor
Lanceur, adapteur



	D (mm)	L (mm)	(g)	(pcs.)
3756Z-1/2	28	29	52	10

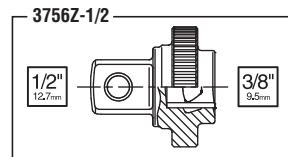

3322AZ-75 Extension Adaptor
Verlängerungsadapter
Reduction adapteur-rallonge



	D (mm)	L (mm)	(g)	(pcs.)
3322AZ-75	17.5	75	42	10

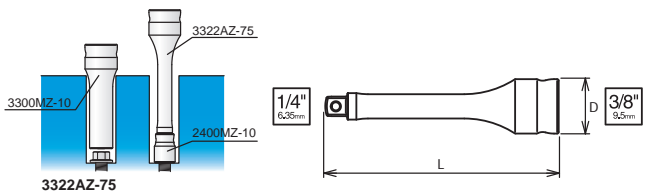



3285Z		26 Pieces Set/△=2,100g	
PLASTIC TRAY:W390xT180xH25			
Sockets		Accessories	
	3400MZ 6-pt. Sockets 5.5, 6, 7, 8, 10, 12, 13, 14, 17, 19, 21, 22		3725Z
	3300MZ 6-pt. Deep Sockets 8, 10, 12, 14		3756Z
	3300CZ Spark Plug Sockets 14, 16, 20.8		3771Z
			3768Z-250
			3760Z-75
			3760Z-125
			3760Z-250

3285Z Set in PE-foam tray
Steckschlüsselsatz in Weichschaumeinlage
Set disposé dans boîte de rangement en mousse souple



3285ZA		15 Pieces Set/△=750g	
PLASTIC TRAY:W300xT90xH25			
Sockets		Accessories	
	3400MZ 6-pt. Sockets 5.5, 6, 7, 8, 10, 12, 13, 14, 17, 19, 21, 22		3725Z
			3756Z
			3771Z

3285ZA Set in PE-foam tray
Steckschlüsselsatz in Weichschaumeinlage
Set disposé dans boîte de rangement en mousse souple



3286Z		21 Pieces Set/△=2,600g	
BLACK METAL CASE:W415xH120xT50mm			
Sockets		Accessories	
	3400MZ 6-pt. Sockets 7, 8, 10, 11, 12, 13, 14, 15, 16, 17, 18, 19, 21, 22		3725Z
			3756Z
			3771Z
			3768Z-250
			3760Z-75
			3760Z-125
			3760Z-250

3286Z Set in PE-foam tray
Steckschlüsselsatz in Weichschaumeinlage
Set disposé dans boîte de rangement en mousse souple



3285ZE		9 Pieces Set/△=600g	
Rail 200mm/PLASTIC BAG			
Sockets		Accessories	
	3400MZ 6-pt. Sockets 8, 10, 12, 13, 14, 17, 19		3725Z
			3756Z

3285ZE Socket Sets
Steckschlüssel Sätze
Jeu de clés à douilles



4400MZ



6-point Sockets
6-kant Steckschlüssel
Douilles 6-pans

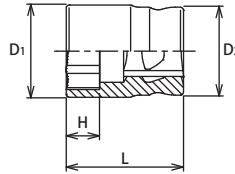

4400MZ (mm)	D ₁ (mm)	D ₂ (mm)	H (mm)	L (mm)	(g)	(pcs.)
8	12.9	20.6	4.5	26	30	10
10	15	20.6	4.5	26	31	10
12	17	20.6	5.5	27	32	10
13	18.3	21.5	6.5	28	40	10
14	19.5	21.5	6.5	28	40	10
16	22	21.5	7.5	29	43	10
17	23	22.5	7.5	29	49	10
18	24.1	23.7	7.5	29	56	10
19	25.3	24.4	9.5	29	62	10
21	27.6	26.3	10.5	29	76	10
22	28.8	27.5	11	29	83	10
24	31.1	29.2	12	29	96	5
27	34.6	32.2	13.5	30	124	5
30	38.1	35.2	14.5	31	156	5
32	40.4	36.8	15.5	32	178	5

RS4400MZ/10



Socket Set on magnetic Rail
Steckschlüsselsatz auf Magnetschiene
Jeu de douilles sur rail à aimant



RS4400MZ/10	10 Pieces Set/Rail 300mm	(g)
10, 12, 13, 14, 17, 19, 21, 22, 24, 27		830

4725Z

Reversible Ratchet
Knarre, verstellbar
Cliquet, réversible

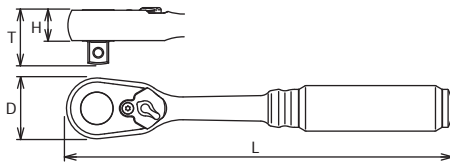

72

	D (mm)	T (mm)	H (mm)	L (mm)	(g)	(pcs.)
4725Z	36.5	32.8	18.2	253	590	1

* Renewal Kits → 4725BRK-2 → P320

4725ZB

Reversible Ratchet with Quick Release Button
Knarre, verstellbar mit Entriegelungsknopf
Cliquet, réversible avec bouton de débrayage

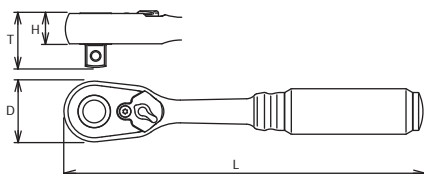

72



	D (mm)	T (mm)	H (mm)	L (mm)	(g)	(pcs.)
4725ZB	36.5	32.8	18.2	253	595	1

* Renewal Kits → 4725BRK-1 → P320

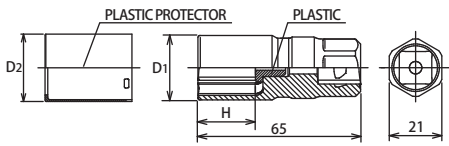

4300PMZ-65

Wheel Nut Socket with Plastic Protector
Radmuttern Steckschlüssel mit Kunststoff Hülse
Douilles pour écrous de roue avec protection en plastique



4300PMZ-65 (mm)	D ₁ (mm)	D ₂ (mm)	H (mm)	Shaft Colour	(g)	(pcs.)
17	23.7	25.2	21	Blue	135	10
19	25.7	27.2	23	Red	150	10
21	27.5	29	25	Yellow	155	10
New 22	29	30.5	26	White	165	10

⚠ Please note that thin walled design is only for wheel nut work and Torque rating is limited.



FREE-TURN
CROSS WRENCH

4711XZ

Spinning Cross Wrench
T-Griff für die Radmuttermontage
Poignée coulissante pour montage des écrous à roue

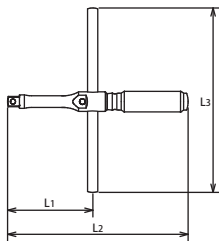

	L1 (mm)	L2 (mm)	L3 (mm)	(g)	(pce.)
4711XZ	133	264	350	915	1



RENEWAL KIT FOR
HINGE HANDLE

OVAL SHAPE
SHANK

4768Z-430

Hinge Handle
Gelenkgriff
Poignée articulée



	D (mm)	L (mm)	(g)	(pce.)
4768Z-430	28	430	720	2

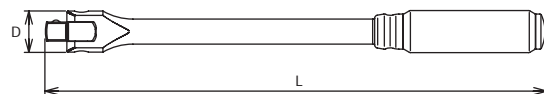

* Renewal Kits → 4768ZRK → P321

⚠ 4768Z-430 have longer handle than standard, and can be loaded to excessive torque value. In the interest of your own safety always apply load evenly and progressively to avoid breakage and possible injury.

Z-SERIES
HAND
TITANIUM
SCREWDRIVERS
ACCESSORIES
IMPACT
SLEEVE-DRIVE
PROTECTOR
INDUSTRIAL
AUTOMOTIVE
MOTORCYCLE
CONSTRUCTION
SPARE PART

4760Z

Extension Bars
Verlängerungen
Rallonges

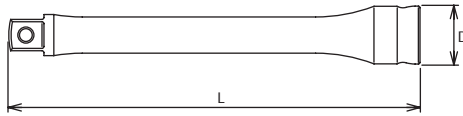

	D (mm)	L (mm)	(g)	(pcs.)
4760Z-125	23	125	180	5
4760Z-250	23	250	340	5

4760LZ

Locking Extension Bars
Verriegelbare Verlängerungen
Barres d'extension verrouillables

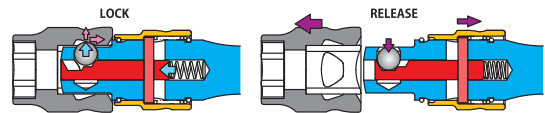
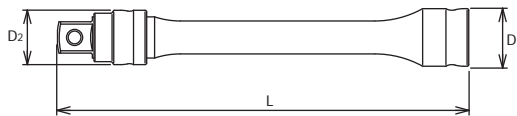

	D ₁ (mm)	D ₂ (mm)	L (mm)	(g)	(pcs.)
4760LZ-125	23	20.5	125	186	5
4760LZ-250	23	20.5	250	346	5

! You may not hold the sliding part while moving to avoid heating up by friction and reduction by wear.

Bitte das gleitende Teil während der Bewegung nicht festhalten, um eine Erhitzung durch Reibung und durch Verschleiß zu vermeiden.

Veuillez ne pas tenir la pièce coulissante pendant le mouvement, afin d'éviter un échauffement dû à la friction et à l'usure.

4771Z

Universal Joint
Gelenk-Einsatz
Joint articulé



UNIVERSAL JOINT

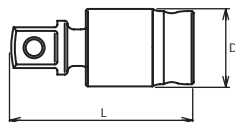
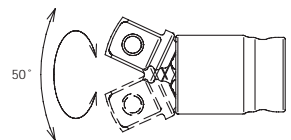

	D (mm)	L (mm)	(g)	(pcs.)
4771Z	23.7	55.8	100	10

1/2"

Z-series
Z-serie
Series-Z

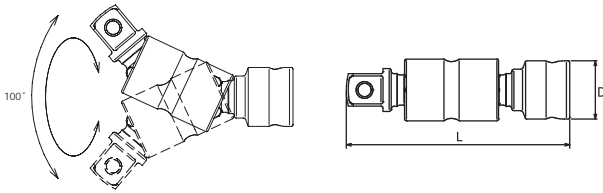

	D (mm)	L (mm)	(g)	(pcs.)
4772Z	23.7	87.2	170	5

4772Z Universal Double Joint
Doppelgelenk-Einsatz
Joint articulé double



RSX772Z/3	3 Pieces Set/Rail 200mm	(g)
New	2772Z, 3772Z, 4772Z	290

1/4" + 3/8" + 1/2"

RSX772Z/3

Universal Joints 1/4", 3/8", 1/2" 3 pcs set on rail
Doppelgelenk-Einsätze 1/4", 3/8", 1/2" 3teiliger Satz auf Schiene
Douilles à double articulation 1/4", 3/8", 1/2" Jeu de 3 pièces sur rail



	D (mm)	L (mm)	(g)	(pcs.)
4756Z	36.3	33.5	84	10

4756Z Quick Spinner
Rändel-Drehscheibe
Lanceur

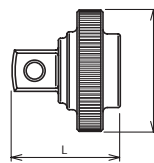





Z-SERIES
HAND
TITANIUM
ACCESSORIES
SCREWDRIVERS
IMPACT
SLEEVE-DRIVE
PROTECTOR
INDUSTRIAL
AUTOMOTIVE
MOTORCYCLE
CONSTRUCTION
SPARE PART

4285Z Set in Foam tray
Steckschlüsselsatz in Weichschaumeinlage
Set disposé dans boîte de rangement en mousse souple



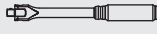
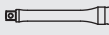
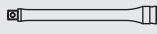

4285Z 21 Pieces Set/△=4,800g
METAL CASE:W445xT190xH50

Sockets	Accessories
 4400MZ 6-pt. Sockets 8, 10, 12, 13, 14, 16, 17, 18, 19, 21, 22, 24, 27, 30, 32	 4725Z  4756Z  4771Z  4768Z-430  4760Z-125  4760Z-250

4285ZE Socket Sets
Steckschlüssel Sätze
Jeu de clés à douilles









4285ZE 11 Pieces Set/△=1,380g
Rail 300mm/PLASTIC BAG

Sockets	Accessories
 4400MZ 6-pt. Sockets 10, 12, 13, 14, 17, 19, 21,22, 24	 4725Z  4756Z

RSAL200  Magnetic Rail with retaining clips
RSAL300 Magnetschiene mit Halteklammern
Rail à aimant avec clips de maintien







RSAL200		RAIL (mm)	CLIP (pcs.)	 (g)	 (pce.)
1/4x12	1/4"	200	12	125	1
3/8x8	3/8"	200	8	130	1

RSAL300		RAIL (mm)	CLIP (pcs.)	 (g)	 (pce.)
3/8x12	3/8"	300	12	180	1
1/2x10	1/2"	300	10	190	1

RSAL Magnetic Rails and retaining Clips, bulk
CLIP.P/5 Magnetschiene und Halteklammern, lose
Rail à aimant avec clips de maintien, en vrac



RAIL	RAIL (mm)	 (g)	 (pce.)
RSAL200	200	110	1
RSAL300	300	145	1
RSAL400	400	210	1

CLIP	CLIP.P/5		 (g)	 (pce.)
	1/4	1/4"	10	5
	3/8	3/8"	13	5
	1/2	1/2"	20	5

HAND

SOCKETS
STECKSCHLÜSSEL
DOUILLES À MAIN

1/4"

3/8"









1/2"





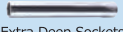
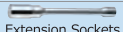





3/4"

1"

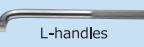

Hand Sockets
Hand Steckschlüssel
Douilles à main

Hand Sockets	Square Drive														
	1/4"(6.35mm)SQ.			3/8"(9.5mm)SQ.			1/2"(12.7mm)SQ.			3/4"(19mm)SQ.			1"(25.4mm)SQ.		
	No.		Page	No.		Page	No.		Page	No.		Page	No.		Page
Standard Sockets		6-point	2400M mm 48	3400M mm 68	4401M/4400M mm 102	6400M mm 130	8400M mm 136								
			2400A inch 48	3400A inch 68	4400A inch 103	6400A inch 130	8400A inch 136								
			2400W BA 49	3400W BSW 69	4400W BSW 104										
		12-point	2405M mm 48	3405M mm 68	4406M/4405M mm 102	6405M mm 130	8405M mm 136								
			2405A inch 48	3405A inch 68	4405A inch 103	6405A inch 130	8405A inch 136								
			AS2405A inch 48	3405W BSW 69	4405W BSW 104										
		Surface	2410M mm 49	3410M mm 69	4410M mm 104										
		NUT GRIP®	2450MS mm 50	3450M mm 71	4450M mm 106										
			2450AS inch 50	3450A inch 71											
				3450MH mm 71											
		NUT GRIP® (3-ball)	2455AS inch 50												
TORX® (E)		2425 TORX® 51	3425 TORX® 70	4425 TORX® 105	6425 TORX® 130										
				4425-N TORX® 104											
TORX®(E) (NUT GRIP®)			3425(2B) TORX® 71												
TORXplus® (EP)				4425-EPL TORXplus® 105											
TORXplus® (EPR)				4425-EPRL TORXplus® 105											
Semi Deep Sockets		LH-S		3400LH LH-STIX® 70	4400LH LH-STIX® 106										
		Double Square	2415M mm 49	3415M mm 70											
			2415A inch 49	3415A inch 70											
Deep Sockets		6-point	2300X mm 51	3300X mm 72											
				3300XA mm 72											
				3305X mm 72											
Extra Deep Sockets		NUT GRIP®	2350X mm 51	3350X mm 72											
		6-point	2300M mm 52	3300M mm 73	4300M mm 107	6300M mm 131									
			2300A inch 52	3300A inch 73	4300A inch 107	6300A inch 131									
			2300W BA 53	3300W BSW 74											
		12-point	2305M mm 52	3305M mm 73	4305M mm 107	6305M mm 131									
			2305A inch 52	3305A inch 73	4305A inch 107	6305A inch 131									
			AS2305A inch 52	3305W BSW 74											
Extension Sockets		Surface	2310M mm 53	3310M mm 74	4310M mm 108										
		NUT GRIP®	2350M mm 53	3350M mm 75											
		TORX® (E)	2325 TORX® 53	3325 TORX® 75	4325 TORX® 108										
		Flare Nut		3300FN mm 75											
		6-point		3300M(L120) mm 76	4300M(L120) mm 109										
Universal Sockets		12-point		3305M(L120) mm 76											
		NUT GRIP®		3350M(L120) mm 76											
				3350A(L120) inch 76											
				3350A(L120) inch 76											
Universal Deep Sockets		TORX® (E) (NUT GRIP®)			4325(L140) TORX® 109										
		12-point		3117M mm 79	4117M mm 109										
Bit Sockets		6-point	2440M mm 54	3440M mm 77	4440M mm 110										
			2440A inch 54	3440A inch 77	4440A inch 110										
		12-point	2445M mm 54	3445M mm 77	4445M mm 110										
			2445A inch 54	3445A inch 77	4445A mm 110										
			AS2445A inch 54	3445W BSW 77	4445A inch 110										
		NUT GRIP®	2441M mm 54	3441M mm 78											
		TORX® (E)	2440T TORX® 54	3440T TORX® 77	4440T TORX® 110										
		6-point		3340M mm 78											
		PH	2000 PH 55	3000 PH 80	4000 PH 110										
		PZ	2000(PZ) PZ 55	3000(PZ) PZ 80	4000(PZ) PZ 110										
		Universal Bit Sockets		Slotted	2005 Slotted 55	3005 Slotted 80	4005 Slotted 110								
Hexagon	2010M mm 56			3010M mm 81	4010M mm 111	6012M mm 131									
	2010A inch 56			3010A inch 81	4010A inch 111	8012M mm 137									
				3012M mm 82	4012M mm 112										
				3012A inch 82	4012A inch 113										
Hexagon (Grip Ring)				3015M mm 83											
Hexagon (Ball Point)	2011M mm 56			3011M mm 83											
XZN (Triple Square)	2020 XZN 56			3020 XZN 84	4020 XZN 114										
TORX® (T)	2025(T) TORX® 57			3025(T) TORX® 85	4025(T) TORX® 115										
TORX® (TH)	2025(TH) TORX® 57			3025(TH) TORX® 86											
TORXplus® (IP)	2025(IP) TORXplus® 58	3025(IP) TORXplus® 87	4025(IP) TORXplus® 116												
TORXplus® (IPR)	2025(IPR) TORXplus® 58	3025(IPR) TORXplus® 88													
Ribe CV		3027 Ribe CV 88	4027 Ribe CV 116												
Hexagon	2430M mm 55	3430M mm 79													
TORX® (T)	2430T TORX® 55														

Handles/Accessories		Square Drive									
		1/4"(6.35mm)SQ.		3/8"(9.5mm)SQ.		1/2"(12.7mm)SQ.		3/4"(19mm)SQ.		1"(25.4mm)SQ.	
		No.	Page	No.	Page	No.	Page	No.	Page	No.	Page
 Ratchet Handles	Standard	2753 series	59-60	3753 series 3752 series	91-92 91	4753 series 4750 series 4752 series	120 119 118	6749 6752	132 132	8749	138
	Short	2753PS	59	3749S series	90						
	Long	2753P-160	59	3753P-250	91	4749-380 series 4753P-410	121 121	6749-1000	132	8749-1000	138
	Compact			2749-3/8 series	90	3749S-1/2 series	118				
	Others			3753SM series 3757	90 95						
 Flexible Ratchet Handles	Standard	2774 series	61	3774 series	93-94	4774 series	121-122				
	Short	2774PS 2774JS	60 60	3774PS	92						
	Long					4774P-450	121				
	Compact			2774-3/8 series	92						
	Swivel Head			3776 series	94						
	Speeder			3774P-SR	94						
 Hinge Handles	Standard	2768 series	62	3768-250 series	97	4768-380 series	122	6768	133	8768	138
	Long					4768-450 series	122	6768-600	133	8768-1000	138
	Extra Long			3768P-380	97	4768-600 series	122	6768-1000	133		
 T-type Slide Handles	Standard	2785	64	3785	98	4785	124	6785	134	8785	138
	Long									8785-700	138
 Spin Type Handles	Standard	2769N	63	3769N	97						
	Wobble-Fix	2769NWF	63	3769NWF	97						
	Others	2769H	63	3769H	97						
 L-handles						4788 4747	125 125	6788	134	8788	138
 Speed Handles	Standard	2780	64	3780	98	4780-400	124				
	Flexible					4781N-450	124				
 Extension Bars	Standard	2760	62	3760	96	4760	123	6760	133	8760	137
	Wobble-Fix	2763	62	3763	96	4763	123				
	Flexible	2762	61	3762	95						
 Universal Joints		2770 2771	64 64	3770 3771	98 98	4770 4771	124 124	6770	134	8770	137
 Adaptors		2233A	64	3322A 3344A	98 98	4433A 4466A	125 125	6644A 6688A	134 134	8866A	137
 Ratchet Adaptors		2755	61	3755	95	4755	122	6755	133		
 Quick Spinners		2756	61	3756	95	4756	122				

Z-SERIES
HAND
TITANIUM
ACCESSORIES
SCREWDRIVERS
IMPACT
SLEEVE-DRIVE
PROTECTOR
INDUSTRIAL
AUTOMOTIVE
MOTORCYCLE
CONSTRUCTION
SPARE PART

Hand Sockets
Hand Steckschlüssel
Douilles à main

1/4"

Z-SERIES

HAND

TITANIUM

SCREWDRIVERS ACCESSORIES

IMPACT

SLEEVE-DRIVE

PROTECTOR

INDUSTRIAL

AUTOMOTIVE

MOTORCYCLE

CONSTRUCTION

SPARE PART

2400M / 2400A

6-point Sockets
6-kant Steckschlüssel
Douilles 6-pans

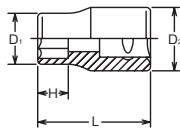

2400M 2405M (mm)	D ₁ (mm)	D ₂ (mm)	H (mm)	L (mm)	(g)	(pcs.)
3	5.5	11.2	2.6	22	7	10
3.5	6.1	11.2	3	22	7	10
4	6.7	11.2	3.5	22	8	10
4.5	7.3	11.2	4	22	8	10
5	8	11.2	5	22	8	10
5.5	8.5	11.2	5.5	22	9	10
6	9.2	11.2	5.5	22	9	10
7	10.3	11.2	6	22	9	10
8	11.2	11.7	6.9	22	11	10
9	13	12	7.3	22	12	10
10	14.3	12.9	7.7	22	15	10
11	15.5	14.3	9.3	22	18	10
12	16.8	15.5	9.3	22	23	10
13	18	16.4	9.8	22	23	10
14	19.3	17.9	11	24	30	10

2405M / 2405A

12-point Sockets
12-kant Steckschlüssel
Douilles 12-pans

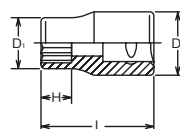

2400A 2405A (inch)	D ₁ (mm)	D ₂ (mm)	H (mm)	L (mm)	(g)	(pcs.)
1/8	5.7	11.2	2.7	22	7	10
5/32	6.7	11.2	3.5	22	8	10
3/16	7.8	11.2	5	22	8	10
7/32	8.5	11.2	5.5	22	9	10
1/4	9.6	11.2	5.8	22	9	10
9/32	10.3	11.2	6	22	9	10
5/16	11.2	11.7	6.9	22	11	10
11/32	12.5	11.7	7.3	22	12	10
3/8	13.7	12.5	7.7	22	15	10
7/16	15.5	14.3	9.3	22	18	10
1/2	18	16.4	9.8	22	23	10
9/16	19.3	17.9	11	24	30	10

RS2400M/12

Socket Set on Rail
Steckschlüsselsatz auf Schiene
Jeu de douilles sur rail



RS2400M/12	12 Pieces Set/Rail 200mm	(g)
4, 5, 5.5, 6, 7, 8, 9, 10, 11, 12, 13, 14		200

RS2405M/12	12 Pieces Set/Rail 200mm	(g)
4, 5, 5.5, 6, 7, 8, 9, 10, 11, 12, 13, 14		200

RS2400A/9

Socket Set on Rail
Steckschlüsselsatz auf Schiene
Jeu de douilles sur rail



RS2400A/9	9 Pieces Set/Rail 150mm	(g)
3/16, 7/32, 1/4, 9/32, 5/16, 11/32, 3/8, 7/16, 1/2		162

RS2405A/9	9 Pieces Set/Rail 150mm	(g)
3/16, 7/32, 1/4, 9/32, 5/16, 11/32, 3/8, 7/16, 1/2		162

AS2405A

12-point Sockets, AS954
12-kant Steckschlüssel, AS954
Douilles 12-pans, AS954

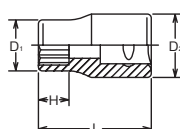

AS2405A (inch)	D ₁ (mm)	D ₂ (mm)	H (mm)	L (mm)	(g)	(pcs.)
3/16	7.7	10.9	5.1	22	8	10
7/32	8.5	10.9	5.5	22	8	10
1/4	9.4	10.9	5.9	22	8	10
9/32	10.2	10.9	6.1	22	8	10
5/16	11.3	11.7	7.3	22	10	10
11/32	12.5	12	7.5	22	10	10
3/8	13.7	12.9	8.2	22	13	10
7/16	15.6	14.3	9.4	22	17	10
1/2	17.2	16.4	10.3	22	20	10
9/16	18.8	17.9	11	24	27	10

Aerospace Standard SAE AS954

RSAS2405A/10

Socket Set on Rail
Steckschlüsselsatz auf Schiene
Jeu de douilles sur rail



RSAS2405A/10	10 Pieces Set/Rail 150mm	(g)
3/16, 7/32, 1/4, 9/32, 5/16, 11/32, 3/8, 7/16, 1/2, 9/16		160

1/4" Hand Sockets Hand Steckschlüssel Douilles à main

2410M (mm)	D ₁ (mm)	D ₂ (mm)	H (mm)	L (mm)	(g)	(pcs.)
4	6.7	11.2	3.5	22	8	10
4.5	7.3	11.2	4	22	8	10
5	8	11.2	5	22	8	10
5.5	8.5	11.2	5.5	22	9	10
6	9.2	11.2	5.5	22	9	10
7	10.3	11.2	6	22	9	10
8	11.2	11.7	6.9	22	11	10
9	13	12	7.3	22	12	10
10	14.3	12.9	7.7	22	15	10
11	15.5	14.3	9.3	22	18	10
12	16.8	15.5	9.3	22	23	10
13	18	16.4	9.8	22	23	10
14	19.3	17.9	11	24	30	10



2410M Surface Drive Sockets
Surface Drive Steckschlüssel
Douilles, Surface Drive

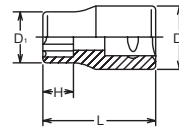

RS2410M/12	12 Pieces Set/Rail 200mm	(g)
4, 5, 5.5, 6, 7, 8, 9, 10, 11, 12, 13, 14		222

RS2410M/12 Socket Set on Rail
Steckschlüsselsatz auf Schiene
Jeu de douilles sur rail



2400W (BA)	D ₁ (mm)	D ₂ (mm)	H (mm)	L (mm)	(g)	(pcs.)
8	6.1	11.2	3	22	7	10
7	7.3	11.2	4	22	8	10
6	8	11.2	5	22	8	10
5	8.5	11.2	5.5	22	9	10
4	9.6	11.2	5.8	22	9	10
3	10.3	11.2	6	22	9	10
2	11.2	11.7	6.9	22	11	10
1	13	12	7.3	22	12	10
0	14.9	13.6	8	22	16	10

2400W-BA 6-point Sockets
6-kant Steckschlüssel
Douilles 6-pans

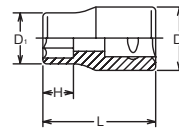

RS2400W/9-BA	9 Pieces Set/Rail 150mm	(g)
8, 7, 6, 5, 4, 3, 2, 1, 0		120

RS2400W/9-BA Socket Set on Rail
Steckschlüsselsatz auf Schiene
Jeu de douilles sur rail



BA



BA	8BA	7BA	6BA	5BA	4BA	3BA	2BA	1BA	0BA	
S	(ref. mm)	3.86	4.37	4.90	5.59	6.30	7.16	8.23	9.27	10.49
	(ref. inch)	0.152	0.172	0.193	0.220	0.248	0.282	0.324	0.365	0.413

2415M (mm)	D ₁ (mm)	D ₂ (mm)	H (mm)	L (mm)	(g)	(pcs.)
5.5	10.3	11.2	5.4	22	10	10
6	11	11.7	5.4	22	13	10
7	12.5	11.7	6.1	22	13	10
8	14.3	12.9	6.8	22	17	10
10	17.4	16	8.2	22	27	10

2415M / 2415A Double 4-point Sockets
Doppelvierkant Steckschlüssel
Douilles mâles 4-pans doubles

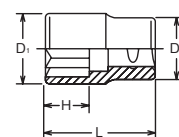

2415A (inch)	D ₁ (mm)	D ₂ (mm)	H (mm)	L (mm)	(g)	(pcs.)
1/4	11	11.7	5.4	22	14	10
5/16	14.3	12.9	6.8	22	17	10
11/32	15.9	14.3	7.5	22	21	10
3/8	17.4	16	8.2	22	26	10

Hand Sockets Hand Steckschlüssel Douilles à main

1/4"

Z-SERIES
HAND
TITANIUM
SCREWDRIVERS ACCESSORIES
IMPACT
SLEEVE-DRIVE
PROTECTOR
INDUSTRIAL
AUTOMOTIVE
MOTORCYCLE
CONSTRUCTION
SPARE PART

2450MS / 2450AS

 Nut Grip Sockets **Nut Grip®**
Steckschlüssel mit 2-facher Kugelhalterung
Douilles à billes de retenue

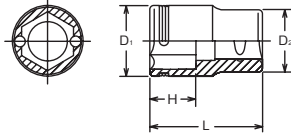

	2450MS (mm)	D ₁ (mm)	D ₂ (mm)	H (mm)	L (mm)	(g)	(pcs.)
New	5	9.2	11.2	3.5	17	6	10
New	5.5	9.8	11.2	3.5	17	7	10
New	6	10.2	11.2	3.5	17	8	10
	7	11.5	11.2	4	18	8	10
	8	12.3	11.7	5	18	9	10
New	9	13.3	12	5.5	19	12	10
	10	14.3	12.9	6	19	13	10
New	11	15.8	14.3	6.5	20	15	10
	12	16.8	16	7	20	22	10
	13	18	17	8	21	22	10
	14	20	18	8.5	22	31	10

	2450AS (inch)	D ₁ (mm)	D ₂ (mm)	H (mm)	L (mm)	(g)	(pcs.)
New	1/4	10.7	11.2	3.5	17	8	10
New	5/16	12.3	11.7	5	18	9	10
New	3/8	14.3	12.9	6	19	14	10
New	7/16	16	14.3	6.5	20	17	10
New	1/2	18	16.4	8	21	23	10
New	9/16	20	18	8.5	22	31	10

RS2450MS/11

 Socket Set on Rail
Steckschlüsselsatz auf Schiene
Jeu de douilles sur rail



	RS2450MS/11	11 Pieces Set/Rail 200mm	(g)
New		5, 5.5, 6, 7, 8, 9, 10, 11, 12, 13, 14	194

RS2450AS/6

 Socket Set on Rail
Steckschlüsselsatz auf Schiene
Jeu de douilles sur rail



	RS2450AS/6	6 Pieces Set/Rail 150mm	(g)
New		1/4, 5/16, 3/8, 7/16, 1/2, 9/16	120

2455AS

 12-point **Nut Grip®** Sockets with 3 Ball retaining
12-kant Steckschlüsseleinsätze mit 3fach Kugelsicherung
Douilles pour écrous à 12 points avec 3 retenues de billes

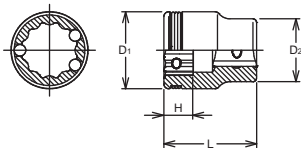

	2455AS (inch)	D ₁ (mm)	D ₂ (mm)	H (mm)	L (mm)	(g)	(pcs.)
New	7/32	10.2	11.2	3.5	17	8	10
New	1/4	11.8	11.2	3.5	17	9	10
New	9/32	12.5	11.2	4	17	10	10
New	5/16	13.5	11.7	5	18	12	10
New	11/32	14.1	12	5.5	19	14	10
New	3/8	15.4	12.9	6	19	16	10
New	7/16	17	15	6.5	20	21	10
New	1/2	18.9	17	8	21	26	10
New	9/16	20.7	18.7	8.5	22.5	34	10

RS2455AS/6

 Socket Set on Rail
Steckschlüsselsatz auf Schiene
Jeu de douilles sur rail



	RS2455AS/6	6 Pieces Set/Rail 150mm	(g)
New		1/4, 5/16, 3/8, 7/16, 1/2, 9/16	138

1/4"

Hand Sockets
Hand Steckschlüssel
Douilles à main

2425 (E)	D ₁ (mm)	D ₂ (mm)	H (mm)	L (mm)	(g)	(pcs.)
E 4	5.4	11.2	4.6	22	7	10
E 5	6.7	11.2	5.2	22	8	10
E 6	7.7	11.2	5.4	22	8	10
E 7	8.3	11.2	6.6	22	9	10
E 8	9.6	11.2	7	22	9	10
E10	11.3	12	8.2	22	10	10
E11	12.9	12	8.7	22	13	10
E12	14.3	12.9	9.3	23	17	10

2425 TORX® Sockets
TORX® Steckschlüssel
Douilles TORX®

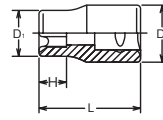

RS2425/6	6 Pieces Set/Rail 150mm	(g)
E4, E5, E6, E7, E8, E10		85

RS2425/6 Socket Set on Rail
Steckschlüsselsatz auf Schiene
Jeu de douilles sur rail



TORX®
(E)

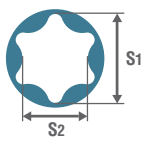

E	E4	E5	E6	E7	E8	E10	E11	E12	E14	E16	E18	E20	E22	E24	E26	E28	E30	E32
S ₁ (ref. mm)	3.7	4.6	5.6	6.1	7.4	9.3	9.9	11.0	12.8	14.6	16.5	18.3	20.1	22.0	23.7	25.5	27.3	29.0
S ₂ (ref. mm)	2.7	3.3	4.0	4.3	5.3	6.8	7.1	7.9	9.2	10.5	11.9	13.2	14.8	15.7	17.5	18.3	20.0	21.3

2300X (mm)	D ₁ (mm)	D ₂ (mm)	H ₁ (mm)	H ₂ (mm)	L (mm)	(g)	(pcs.)
4	6.7	11.2	4	22	32	10	10
5	8	11.2	5.5	22	32	11	10
5.5	8.5	11.2	6	22	32	12	10
6	9.2	11.2	7	22	32	12	10
7	10.5	11.2	8	22	32	13	10
8	11.8	11.2	9	22	32	16	10
9	13	12	10	22	32	18	10
10	14.3	12.9	11	21	32	23	10
11	15.5	14.3	12	21	32	27	10
12	16.8	15.5	13	21	32	29	10
13	18	16.4	14	21	32	32	10
14	19.3	17.9	16	20	32	37	10

2300X 6-point Sockets, Semi-Deep
6-kant Steckschlüssel, mittel-lang
Douilles, semi-profondes 6-pan

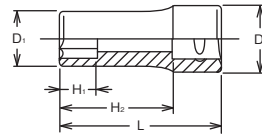

RS2300X/12	12 Pieces Set/Rail 200mm	(g)
4, 5, 5.5, 6, 7, 8, 9, 10, 11, 12, 13, 14		270

RS2300X/12 Socket Set on Rail
Steckschlüsselsatz auf Schiene
Jeu de douilles sur rail



2350X (mm)	D ₁ (mm)	D ₂ (mm)	H ₁ (mm)	H ₂ (mm)	L (mm)	(g)	(pcs.)
8	12.3	11.7	5	21.5	32	17	10
10	14.3	12.9	6	21.5	32	22	10
12	16.8	16	7	21.5	32	34	10
13	18	17	8	21.5	32	40	10
14	20	18	8.5	21.5	32	43	10

2350X Nut Grip Socket, Semi-Deep **Nut Grip®**
Steckschlüssel mit 2-facher Kugelhalterung, mittel-lang
Douilles à billes de retenue, semi-profondes

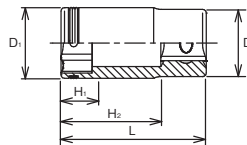

RS2350X/4	4 Pieces Set/Rail 150mm	(g)
8, 10, 12, 14		140

RS2350X/4 Socket Set on Rail
Steckschlüsselsatz auf Schiene
Jeu de douilles sur rail



Hand Sockets Hand Steckschlüssel 1/4" Douilles à main

Z-SERIES

HAND

TITANIUM

SCREWDRIVERS ACCESSORIES

IMPACT

SLEEVE-DRIVE

PROTECTOR

INDUSTRIAL

AUTOMOTIVE

MOTORCYCLE

CONSTRUCTION

SPARE PART

2300M / 2300A 6-point Deep Sockets 6-kant-Steckschlüssel, lang Douilles longues 6-pans

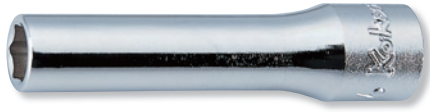

FLAT DRIVE®

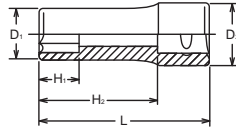

2300M 2305M (mm)	D ₁ (mm)	D ₂ (mm)	H ₁ (mm)	H ₂ (mm)	L (mm)	(g)	(pcs.)
3	5.5	11.2	3	40	50	15	10
4	6.7	11.2	4	40	50	15	10
4.5	7.3	11.2	4.5	40	50	15	10
5	8	11.2	5.5	40	50	17	10
5.5	8.5	11.2	6	40	50	17	10
6	9.2	11.2	7	40	50	20	10
7	10.5	11.2	8	40	50	25	10
8	11.8	11.2	9	40	50	25	10
9	13	12	10	40	50	30	10
10	14.3	12.9	11	39	50	34	10
11	15.5	14.3	12	39	50	43	10
12	16.8	15.5	13	39	50	50	10
13	18	16.4	14	39	50	52	10
14	19.3	17.9	16	38	50	57	10

2305M / 2305A 12-point Deep Sockets 12-kant Steckschlüssel, lang Douilles longues, 12-pans

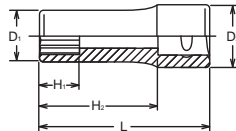

2300A 2305A (inch)	D ₁ (mm)	D ₂ (mm)	H ₁ (mm)	H ₂ (mm)	L (mm)	(g)	(pcs.)
1/8	5.7	11.2	3.5	40	50	15	10
5/32	6.7	11.2	4	40	50	15	10
3/16	7.8	11.2	5.5	40	50	17	10
7/32	8.5	11.2	6	40	50	17	10
1/4	9.8	11.2	7	40	50	25	10
9/32	10.5	11.2	8	40	50	25	10
5/16	11.8	11.2	9	40	50	25	10
11/32	12.5	11.7	10	40	50	30	10
3/8	13.7	12.5	11	40	50	34	10
7/16	15.5	14.3	12	39	50	43	10
1/2	18	16.4	14	39	50	52	10
9/16	19.3	17.9	16	38	50	57	10

RS2300M/12 Socket Set on Rail Steckschlüsselsatz auf Schiene Jeu de douilles sur rail



RS2300M/12	12 Pieces Set/Rail 200mm	(g)
4, 5, 5.5, 6, 7, 8, 9, 10, 11, 12, 13, 14		400

RS2305M/12	12 Pieces Set/Rail 200mm	(g)
4, 5, 5.5, 6, 7, 8, 9, 10, 11, 12, 13, 14		400

RS2300A/9 Socket Set on Rail Steckschlüsselsatz auf Schiene Jeu de douilles sur rail



RS2300A/9	9 Pieces Set/Rail 150mm	(g)
3/16, 7/32, 1/4, 9/32, 5/16, 11/32, 3/8, 7/16, 1/2		296

RS2305A/9	9 Pieces Set/Rail 150mm	(g)
3/16, 7/32, 1/4, 9/32, 5/16, 11/32, 3/8, 7/16, 1/2		296

AS2305A 12-point Deep Sockets, AS954 12-kant Steckschlüssel, lang, AS954 Douilles longues 12-pans, AS954

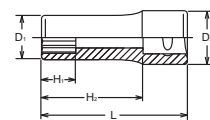

AS2305A (inch)	D ₁ (mm)	D ₂ (mm)	H ₁ (mm)	H ₂ (mm)	L (mm)	(g)	(pcs.)
3/16	7.7	10.9	6	40	50	17	10
7/32	8.5	10.9	6.5	40	50	17	10
1/4	9.4	10.9	7	40	50	19	10
9/32	10.2	10.9	8	40	50	18	10
5/16	11.3	11.7	9	40	50	23	10
11/32	12.5	12	10	40	50	24	10
3/8	13.7	12.8	11	39	50	31	10
7/16	15.6	14.2	12	39	50	38	10
1/2	17.2	16.2	14	39	50	42	10
9/16	18.8	17.1	16	38	50	47	10

Aerospace Standard SAE AS954

RSAS2305A/10	10 Pieces set/Rail 150mm	(g)
3/16, 7/32, 1/4, 9/32, 5/16, 11/32, 3/8, 7/16, 1/2, 9/16		307

RSAS2305A/10 Socket Set on Rail Steckschlüsselsatz auf Schiene Jeu de douilles sur rail



2310M (mm)	D ₁ (mm)	D ₂ (mm)	H ₁ (mm)	H ₂ (mm)	L (mm)	(g)	(pcs.)
3	5.5	11.2	3	40	50	15	10
4	6.7	11.2	4	40	50	15	10
4.5	7.3	11.2	4.5	40	50	15	10
5	8	11.2	5.5	40	50	17	10
5.5	8.5	11.2	6	40	50	17	10
6	9.2	11.2	7	40	50	20	10
7	10.5	11.2	8	40	50	25	10
8	11.8	11.2	9	40	50	25	10
9	13	12	10	40	50	30	10
10	14.3	12.9	11	39	50	34	10
11	15.5	14.3	12	39	50	43	10
12	16.8	15.5	13	39	50	50	10
13	18	16.4	14	39	50	52	10
14	19.3	17.9	16	38	50	57	10



2310M Surface Drive Deep Sockets
Surface Drive Steckschlüssel, lang
Douilles longues, Surface Drive

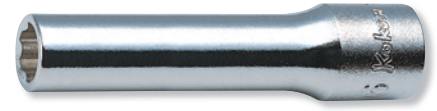
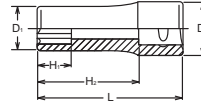

RS2310M/12	12 Pieces set/Rail 200mm	(g)
4, 5, 5.5, 6, 7, 8, 9, 10, 11, 12, 13, 14		400

RS2310M/12 Socket Set on Rail
Steckschlüsselsatz auf Schiene
Jeu de douilles sur rail



2300W (BA)	D ₁ (mm)	D ₂ (mm)	H ₁ (mm)	H ₂ (mm)	L (mm)	(g)	(pcs.)
4	9.8	11.2	7	40	50	22	10
3	10.5	11.2	8	40	50	25	10
2	11.8	11.2	9	40	50	25	10
1	13	12	10	40	50	30	10
0	14.9	13.6	12	39	50	38	10

2300W-BA 6-point Deep Sockets
6-kant-Steckschlüssel, lang
Douilles longues 6-pans

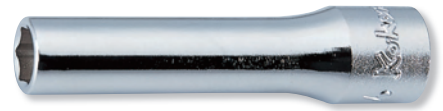
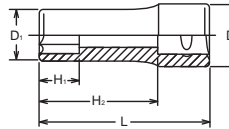

BA



	BA	8BA	7BA	6BA	5BA	4BA	3BA	2BA	1BA	0BA
S	(ref. mm)	3.86	4.37	4.90	5.59	6.30	7.16	8.23	9.27	10.49
	(ref. inch)	0.152	0.172	0.193	0.220	0.248	0.282	0.324	0.365	0.413

2325 (E)	D ₁ (mm)	D ₂ (mm)	H ₁ (mm)	H ₂ (mm)	L (mm)	(g)	(pcs.)
E 4	5.4	12	4.6	40	50	17	10
E 5	6.8	12	5.2	40	50	20	10
E 6	8	12	5.4	40	50	20	10
E 7	8.3	12	6.6	40	50	22	10
E 8	9.8	12	7	40	50	25	10
E10	11.6	12	8.2	40	50	29	10

2325 TORX® Deep Sockets
TORX® Steckschlüssel, lang
Douilles longues TORX®

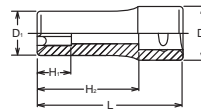

TORX®
(E)

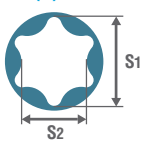

E	E4	E5	E6	E7	E8	E10	E11	E12	E14	E16	E18	E20	E22	E24	E26	E28	E30	E32
S ₁ (ref. mm)	3.7	4.6	5.6	6.1	7.4	9.3	9.9	11.0	12.8	14.6	16.5	18.3	20.1	22.0	23.7	25.5	27.3	29.0
S ₂ (ref. mm)	2.7	3.3	4.0	4.3	5.3	6.8	7.1	7.9	9.2	10.5	11.9	13.2	14.8	15.7	17.5	18.3	20.0	21.3

2350M (mm)	D ₁ (mm)	D ₂ (mm)	H ₁ (mm)	H ₂ (mm)	L (mm)	(g)	(pcs.)
8	12.3	11.7	5	39.5	50	30	10
10	14.3	12.9	6	39.5	50	35	10
12	16.8	16	7	39.5	50	55	10
13	18	17	8	39.5	50	65	10
14	20	18	8.5	39.5	50	70	10



2350M Nut Grip Deep Sockets **Nut Grip®**
Steckschlüssel mit 2-facher Kugelhalterung, lang
Douilles longues à billes de retenue

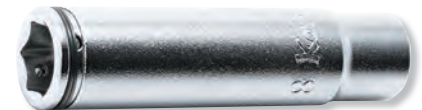
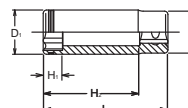

RS2350M/4 Socket Set on Rail
Steckschlüsselsatz auf Schiene
Jeu de douilles sur rail



RS2350M/4	4 Pieces Set/Rail 150mm	(g)
8, 10, 12, 14		220

Hand Sockets Hand Steckschlüssel 1/4" Douilles à main

Z-SERIES
HAND
TITANIUM
SCREWDRIVERS ACCESSORIES
IMPACT
SLEEVE-DRIVE
PROTECTOR
INDUSTRIAL
AUTOMOTIVE
MOTORCYCLE
CONSTRUCTION
SPARE PART

2440M / 2440A

6-point Universal Sockets
6-kant Gelenk-Einsätze
Douilles articulées, 6-pans

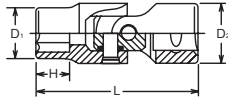

2445M / 2445A

12-point Universal Sockets
12-kant Gelenk-Einsätze
Douilles articulées, 12-pans

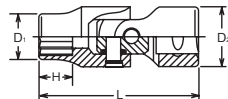

RS2445A/9

Socket Set on Rail
Steckschlüsselsatz auf Schiene
Jeu de douilles sur rail



AS2445A

12-point Universal Sockets
12-kant Gelenk-Einsätze
Douilles articulées, 12-pans

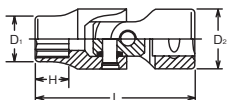

2440T

TORX® Universal Sockets
TORX® Gelenk-Einsätze
Douilles articulées TORX®

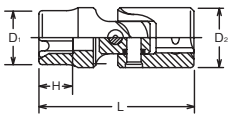

2441M

Nut Grip Universal Sockets **Nut Grip®**
Gelenk-Einsätze mit zweifacher Kugelhalterung
Douilles articulées à billes de retenue

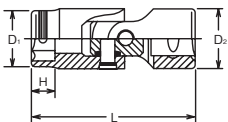
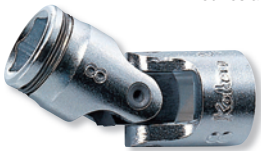

RS2441M/11

Socket Set on Rail
Steckschlüsselsatz auf Schiene
Jeu de douilles sur rail



2440M 2445M (mm)	D ₁ (mm)	D ₂ (mm)	H (mm)	L (mm)	(g)	(pcs.)
4	6.7	13	4.8	31.5	17	10
5	8	13	5.3	32	17	10
6	9.2	13	6.1	33	18	10
7	10.5	13	6.5	33	19	10
8	11.7	13	7	34	19	10
9	13	13	7	34	20	10
10	14.2	13	8.3	35	20	10
11	15.5	13	9.5	36	21	10
12	16.7	13	10	37	21	10
13	18	13	10.5	37	26	10
14	19.2	13	10.5	37	28	10

2440A (inch)	D ₁ (mm)	D ₂ (mm)	H (mm)	L (mm)	(g)	(pcs.)
1/4	9.8	13	6.5	33	18	10
5/16	11.7	13	7	34	19	10
3/8	13.7	13	8.3	35	20	10
7/16	15.5	13	9.5	36	21	10
1/2	18	13	10.5	37	26	10
9/16	19.2	13	10.5	37	28	10

2445A (inch)	D ₁ (mm)	D ₂ (mm)	H (mm)	L (mm)	(g)	(pcs.)
3/16	8	13	5.3	32	18	10
1/4	9.8	13	6.5	33	18	10
9/32	10.5	13	6.5	33	19	10
5/16	11.7	13	7	34	19	10
11/32	13	13	7	34	20	10
3/8	13.7	13	8.3	35	20	10
7/16	15.5	13	9.5	36	21	10
1/2	18	13	10.5	37	26	10
9/16	19.2	13	10.5	37	28	10

RS2445A/9	9 Pieces set/Rail 150mm	(g)
3/16, 1/4, 9/32, 5/16, 11/32, 3/8, 7/16, 1/2, 9/16		220

AS2445A (inch)	D ₁ (mm)	D ₂ (mm)	H (mm)	L (mm)	(g)	(pcs.)
1/4	9.6	12.9	5.7	31.8	18	10
5/16	11.7	12.9	7	34.6	21	10
3/8	13.5	12.9	8.3	35.1	21	10
7/16	15.5	12.9	9.5	39.1	25	10
1/2	17.2	12.9	10.5	40.1	27	10

2440T (E)	D ₁ (mm)	D ₂ (mm)	H (mm)	L (mm)	(g)	(pcs.)
E 6	8	13	5.4	31.9	20	10
E 8	9.8	13	7	33.1	20	10
E10	11.7	13	8.2	33.6	21	10
E12	14.2	13	9.3	35.1	24	10

2441M (mm)	D ₁ (mm)	D ₂ (mm)	H (mm)	L (mm)	(g)	(pcs.)
New 5	9.2	13	3.5	31.5	20	10
New 5.5	9.8	13	3.5	31.5	20	10
6	10.2	13	3.5	31.5	19	10
7	11.3	13	4	31.5	20	10
8	12.3	13	5	32	20	10
10	14.5	13	6	32.5	21	10
New 11	15.5	13	6.5	33.5	21	10
12	16.8	13	7	34	24	10
13	18	13	8	35	25	10
14	20	13	8.5	35.5	30	10
New 15	21	13	9	36	32	10

RS2441M/11	11 Pieces Set/Rail 200mm	(g)
New 5, 5.5, 6, 7, 8, 10, 11, 12, 13, 14, 15		280

2430M (mm)	D (mm)	H (mm)	L (mm)	(g)	(pcs.)
3	13	5.5	40	18	10
4	13	5.5	40	18	10
5	13	6.5	40	20	10
6	13	7.5	40	21	10

2430M Universal Hex Sockets Gelenk-Einsätze für Schrauben mit Innensechskant Douilles articulées, 6-pans mâles

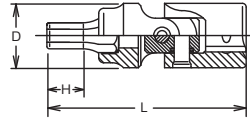

2430T (T)	D (mm)	L (mm)	(g)	(pcs.)
T 8	13	42	22	10
T 9	13	42	22	10
T10	13	42	22	10
T15	13	42	22	10
T20	13	42	22	10
T25	13	42	22	10
T27	13	42	22	10
T30	13	42	22	10

2430T TORX® Universal Sockets TORX® Gelenk-Einsätze Douilles articulées TORX®

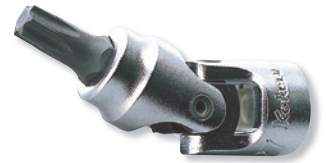
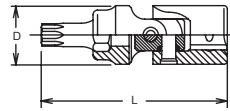

2000-28 (PH)	D (mm)	H (mm)	L (mm)	(g)	(pcs.)
1	11.9	12	28	10	10
2	11.9	12	28	11	10
3	11.9	12	28	12	10
4	13.1	11	28	14	10

2000-28 (PH) PH Bit Sockets Steckschlüssel für Kreuzschlitzschrauben, PH Douilles tournevis pour vis à empreinte PH

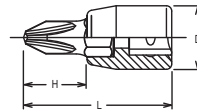

2000-28 (PZ)	D (mm)	H (mm)	L (mm)	(g)	(pcs.)
PZ1	11.9	12	28	10	10
PZ2	11.9	12	28	11	10
PZ3	11.9	12	28	12	10

2000-28 (PZ) PZ Bit Sockets Steckschlüssel für Kreuzschlitzschrauben, PZ Douilles tournevis pour vis à empreinte PZ

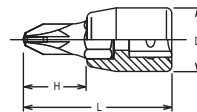

2005-25	TxW (mm)	D (mm)	H (mm)	L (mm)	(g)	(pcs.)
3	0.5x 3	11.9	9	25	9	10
4	0.8x 4	11.9	9	25	10	10
5	1.0x 5.5	11.9	9	25	10	10
6	1.2x 6.5	13.1	9	25	11	10
8	1.2x 8	13.1	9	25	12	10
9	1.6x 8	13.1	9	25	12	10
10	1.6x10	14.3	9	25	13	10

2005-25 Bit Sockets for Slotted Head Steckschlüssel für Schlitzschrauben Douilles tournevis pour vis à fente

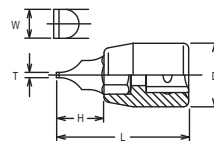

Hand Sockets Hand Steckschlüssel 1/4" Douilles à main

Z-SERIES
HAND
TITANIUM
SCREWDRIVERS ACCESSORIES
IMPACT
SLEEVE-DRIVE
PROTECTOR
INDUSTRIAL
AUTOMOTIVE
MOTORCYCLE
CONSTRUCTION
SPARE PART

2010M-25 / -100 2010A-25 / -100

 Inhex Bit Sockets
Steckschlüssel für Innensechskant-Schrauben
Douilles tournevis pour vis 6-pans creux

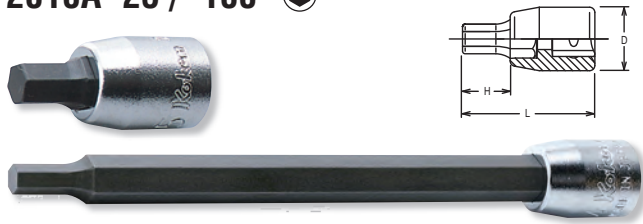

2010A-25 (inch)	D (mm)	H (mm)	L (mm)	(g)	(pcs.)
1/8	11.9	9	25	9	10
5/32	11.9	9	25	9	10
3/16	11.9	9	25	10	10
7/32	11.9	9	25	11	10
1/4	11.9	9	25	12	10
9/32	13.1	8	25	12	10
5/16	13.1	8	25	14	10
3/8	14.3	8	25	17	10
7/16	18.1	8	25	35	10

2010A-100 (inch)	D (mm)	H (mm)	L (mm)	(g)	(pcs.)
New 1/8	11.9	84	100	29	10
New 5/32	11.9	84	100	30	10
New 3/16	13.1	83	100	45	10
New 7/32	13.1	83	100	46	10
New 1/4	13.1	83	100	46	10
New 9/32	13.1	83	100	47	10
New 5/16	13.1	83	100	49	10
New 3/8	14.3	83	100	75	10

2010M-25 (mm)	D (mm)	H (mm)	L (mm)	(g)	(pcs.)
1.5	11.9	9	25	9	10
2	11.9	9	25	9	10
2.5	11.9	9	25	9	10
3	11.9	9	25	9	10
4	11.9	9	25	9	10
5	11.9	9	25	10	10
6	11.9	9	25	12	10
7	13.1	8	25	12	10
8	13.1	8	25	14	10
10	14.3	8	25	17	10
12	16.4	8	25	36	10

2010M-100 (mm)	D (mm)	H (mm)	L (mm)	(g)	(pcs.)
2	11.9	84	100	30	10
2.5	11.9	84	100	30	10
3	11.9	84	100	30	10
4	11.9	84	100	30	10
5	13.1	83	100	30	10
6	13.1	83	100	35	10
7	13.1	83	100	35	10
8	13.1	83	100	38	10
10	14.3	83	100	45	10
12	16.4	83	100	107	10

RS2010M/7-L25 RS2010A/8-L25

 Socket Set on Rail
Steckschlüsselsatz auf Schiene
Jeu de douilles sur rail



RS2010M/7-L25	7 Pieces set/Rail 150mm	(g)
3, 4, 5, 6, 7, 8, 10		115
RS2010A/8-L25	8 Pieces set/Rail 150mm	(g)
1/8, 5/32, 3/16, 7/32, 1/4, 9/32, 5/16, 3/8		130

2011M-50

 Ballpoint Inhex Sockets
Steckschlüssel mit Kugelkopf, für Innensechskant-Schrauben
Douilles tournevis avec tête sphérique pour vis 6-pans creux



 Ball point bit sockets have less strength due to the special design. Make sure to use them correctly.

Kugelkopf-Biteinsätze haben aufgrund der speziellen Form eine geringere Festigkeit. Achten Sie darauf, sie richtig zu verwenden.

Les douilles pour embouts à tête sphérique sont moins résistantes en raison de leur conception spéciale. Veuillez les utiliser correctement.

2020-28 / -50

 XZN Bit Sockets
Steckschlüssel für XZN Schrauben
Douilles tournevis pour empreinte XZN



2020-28 (XZN)	D (mm)	H (mm)	L (mm)	(g)	(pcs.)
M4	11.9	12	28	12	10
M5	11.9	12	28	12	10
M6	11.9	12	28	13	10
M8	13.1	11	28	14	10

2020-50 (XZN)	D (mm)	H (mm)	L (mm)	(g)	(pcs.)
M4	11.9	34	50	20	10
M5	11.9	34	50	20	10
M6	11.9	34	50	22	10
M8	13.1	33	50	24	10

XZN

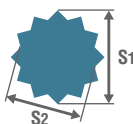

XZN		M4	M5	M6	M8	M10	M12	M14	M16	M18
S ₁	(ref. mm)	3.6	4.8	6.1	7.3	9.7	11.5	13.3	15.7	16.9
S ₂	(ref. mm)	3.1	4.1	5.1	6.1	8.1	9.7	11.2	13.2	14.2

2025-28 (T)	D (mm)	H (mm)	L (mm)	(g)	(pcs.)
T 8	11.9	12	28	10	10
T 9	11.9	12	28	10	10
T10	11.9	12	28	10	10
T15	11.9	12	28	10	10
T20	11.9	12	28	11	10
T25	11.9	12	28	11	10
T27	11.9	12	28	12	10
T30	11.9	12	28	12	10
T40	11.9	12	28	13	10

2025-80 (T)	D (mm)	H (mm)	L (mm)	(g)	(pcs.)
T10	11.9	64	80	40	10
T15	11.9	64	80	40	10
T20	11.9	64	80	42	10
T25	11.9	64	80	42	10
T27	11.9	64	80	45	10
T30	11.9	64	80	45	10
T40	11.9	64	80	50	10

RS2025/7-L28	7 Pieces set/Rail 150mm	(g)
T10, T15, T20, T25, T27, T30, T40		119

2025-28 / -80 (T)

TORX® Bit Sockets
TORX® Bit-Steckschlüssel
Douilles tournevis, TORX®

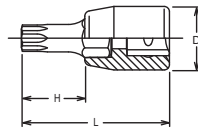

RS2025/7-L28

Socket Set on Rail
Steckschlüsselsatz auf Schiene
Jeu de douilles sur rail



TORX® (T)

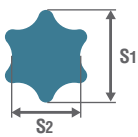

T	T8	T9	T10	T15	T20	T25	T27	T30	T40	T45	T50	T55	T60	T70	T80	T90	T100
S ₁ (ref. mm)	2.3	2.5	2.7	3.3	3.9	4.5	5.0	5.6	6.7	7.9	8.9	11.3	13.3	15.6	17.6	20.0	22.2
S ₂ (ref. mm)	1.7	1.8	2.0	2.3	2.8	3.2	3.6	4.0	4.8	5.6	6.2	8.0	9.5	11.1	12.7	14.2	15.8

2025-28 (TH)	D (mm)	H (mm)	L (mm)	(g)	(pcs.)
T10H	11.9	12	28	10	10
T15H	11.9	12	28	10	10
T20H	11.9	12	28	11	10
T25H	11.9	12	28	11	10
T27H	11.9	12	28	12	10
T30H	11.9	12	28	12	10
T40H	11.9	12	28	13	10

2025-28 (TH)

Tamper-Resistant TORX® Bit Sockets
Tamper-Resistant TORX® Bit-Steckschlüssel
Douilles tournevis, Tamper-Resistant TORX®

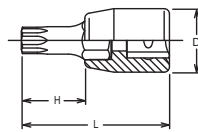

RS2025/7-HOLE	7 Pieces set/Rail 150mm	(g)
T10H, T15H, T20H, T25H, T27H, T30H, T40H		119



RS2025/7-HOLE

Socket Set on Rail
Steckschlüsselsatz auf Schiene
Jeu de douilles sur rail



⚠ Tamper Resistant TORX® Bit Sockets have less strength due to special design. Make sure to use it correctly.

Die manipulationssicheren TORX®-Bit-Einsätze haben aufgrund ihres speziellen Designs eine geringere Festigkeit. Achten Sie darauf, sie richtig zu verwenden.

Les douilles à embouts TORX® à l'abri des manipulations ont une résistance moindre en raison de leur conception spéciale. Veuillez les utiliser correctement.

Hand Sockets Hand Steckschlüssel Douilles à main

1/4"

Z-SERIES
HAND
TITANIUM
SCREWDRIVERS ACCESSORIES
IMPACT
SLEEVE-DRIVE
PROTECTOR
INDUSTRIAL
AUTOMOTIVE
CONSTRUCTION MOTORCYCLE
SPARE PART

2025-28 (IP)



TORXPLUS® Bit Sockets
TORXPLUS® Bit-Steckschlüssel
Douilles tournevis, TORXPLUS®

TORXplus®

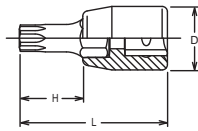

RS2025/7-IP



Socket Set on Rail
Steckschlüsselsatz auf Schiene
Jeu de douilles sur rail



2025-28 (IP)	D (mm)	H (mm)	L (mm)	(g)	(pcs.)
8IP	11.9	12	28	10	10
9IP	11.9	12	28	10	10
10IP	11.9	12	28	10	10
15IP	11.9	12	28	10	10
20IP	11.9	12	28	11	10
25IP	11.9	12	28	11	10
27IP	11.9	12	28	12	10
30IP	11.9	12	28	12	10
40IP	11.9	12	28	13	10

RS2025/7-IP	7 Pieces set/Rail 150mm	(g)
10IP, 15IP, 20IP, 25IP, 27IP, 30IP, 40IP		119

TORXPLUS® (IP)

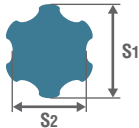

IP	8IP	9IP	10IP	15IP	20IP	25IP	27IP	30IP	40IP	45IP	50IP	55IP	60IP	70IP
S ₁ (ref. mm)	2.3	2.5	2.7	3.3	3.9	4.5	5.0	5.6	6.7	7.9	8.9	11.3	13.3	15.6
S ₂ (ref. mm)	1.8	1.9	2.1	2.5	3.0	3.4	3.9	4.3	5.2	6.2	6.9	9.0	10.4	12.3

2025-28 (IPR)



Tamper-Resistance TORXPLUS® Bit Sockets
Tamper-Resistance TORXPLUS® Bit-Steckschlüssel
Douilles tournevis TORXPLUS® avec trou

TORXplus®

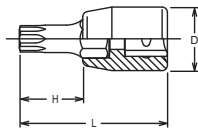

RS2025/7-IPR



Socket Set on Rail
Steckschlüsselsatz auf Schiene
Jeu de douilles sur rail



2025-28 (IPR)	D (mm)	H (mm)	L (mm)	(g)	(pcs.)
8IPR	11.9	12	28	10	10
9IPR	11.9	12	28	10	10
10IPR	11.9	12	28	10	10
15IPR	11.9	12	28	10	10
20IPR	11.9	12	28	11	10
25IPR	11.9	12	28	11	10
27IPR	11.9	12	28	12	10
30IPR	11.9	12	28	12	10
40IPR	13.1	12	28	13	10

RS2025/7-IPR	7 Pieces set/Rail 150mm	(g)
10IPR, 15IPR, 20IPR, 25IPR, 27IPR, 30IPR, 40IPR		119

TORXPLUS® (IPR)

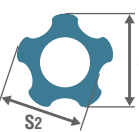

IPR	8IPR	9IPR	10IPR	15IPR	20IPR	25IPR	27IPR	30IPR	40IPR	45IPR	50IPR	55IPR
S ₁ (ref. mm)	2.2	2.4	2.6	3.1	3.6	4.1	4.7	5.2	6.3	7.4	8.4	10.6
S ₂ (ref. mm)	2.0	2.2	2.4	2.8	3.3	3.8	4.3	4.8	5.7	6.7	7.6	9.7

2137



Bit Holder
Klingenhalter
Porte-embouts

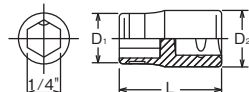

	D ₁ (mm)	D ₂ (mm)	L (mm)	(g)	(pcs.)
2137	12	12	22.5	13	10

For DIN3126 C6.3 Bits
Für DIN3126 C6.3 Bits
Pour DIN3126 C6.3 Embouts

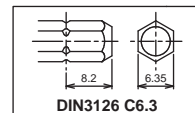

2138



Bit Holder
Klingenhalter
Porte-embouts

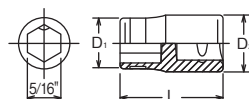

	D ₁ (mm)	D ₂ (mm)	L (mm)	(g)	(pcs.)
2138	16	16	26	32	10

For DIN3126 C8 Bits
Für DIN3126 C8 Bits
Pour DIN3126 C8 Embouts

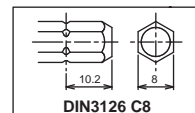

1/4" Hand Sockets Hand Steckschlüssel Douilles à main



* Renewal Kits → 2753RK → P318



2753PS Reversible Ratchet (Short)
Knarre kurz, verstellbar
Cliquet courte, réversible



	D (mm)	T (mm)	H (mm)	L (mm)	(g)	(pcs.)
2753PS	22	18.7	11.4	75	55	5

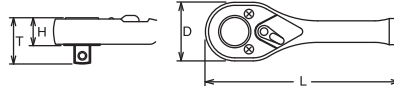

* Renewal Kits → 2753RK → P318

2753J Reversible Ratchet
Knarre, verstellbar
Cliquet, réversible



* Renewal Kits → 2753RK → P318

2753P Reversible Ratchet
Knarre, verstellbar
Cliquet, réversible



* Renewal Kits → 2753RK → P318

2753N Reversible Ratchet
Knarre, verstellbar
Cliquet, réversible



	D (mm)	T (mm)	H (mm)	L (mm)	(g)	(pcs.)
2753J	22	18.7	11.4	115	77	1
2753P	22	18.7	11.4	115	87	1
2753N	22	18.7	11.4	115	90	1

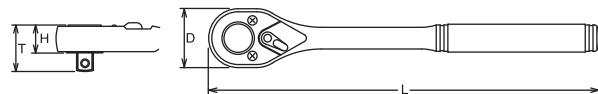

* Renewal Kits → 2753RK → P318

2753P-160 Reversible Ratchet (Long)
Verstellbare Knarre, lang
Cliquet réversible, longue



	D (mm)	T (mm)	H (mm)	L (mm)	(g)	(pcs.)
2753P-160	22	18.7	11.4	160	107	1

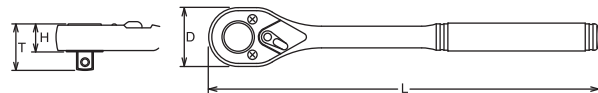

⚠ 2753P-160 have longer handle than standard, and can be loaded to excessive torque value. In the interest of your own safety always apply load evenly and progressively to avoid breakage and possible injury.

Z-SERIES
HAND
TITANIUM
ACCESSORIES
SCREWDRIVERS
IMPACT
SLEEVE-DRIVE
PROTECTOR
INDUSTRIAL
AUTOMOTIVE
MOTORCYCLE
CONSTRUCTION
SPARE PART

Hand Sockets Hand Steckschlüssel Douilles à main

1/4"

Z-SERIES
HAND
TITANIUM
SCREWDRIVERS ACCESSORIES
IMPACT
SLEEVE-DRIVE
PROTECTOR
INDUSTRIAL
AUTOMOTIVE
MOTORCYCLE
CONSTRUCTION
SPARE PART

2753JB Reversible Ratchet with quick release button
Knarre, verstellbar mit Entriegelungsknopf
Cliquet, réversible avec bouton de débrayage



* Renewal Kits → 2753BRK → P318

2753PB Reversible Ratchet with quick release button
Knarre, verstellbar mit Entriegelungsknopf
Cliquet, réversible avec bouton de débrayage



* Renewal Kits → 2753BRK → P318

2753NB Reversible Ratchet with quick release button
Knarre, verstellbar mit Entriegelungsknopf
Cliquet, réversible avec bouton de débrayage



* Renewal Kits → 2753BRK → P318

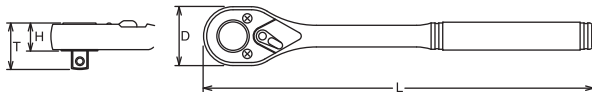

	D (mm)	T (mm)	H (mm)	L (mm)	(g)	(pce.)
2753JB	22	18.7	11.4	115	77	1
2753PB	22	18.7	11.4	115	87	1
2753NB	22	18.7	11.4	115	90	1

Reversible Ratchet with Quick Release Button :
Sockets and accessories are safely locked. By pushing the button the sockets or extension bars are released from the ratchet.

Umstellbare Knarre mit Entriegelungsknopf :
Steckschlüssel und Zubehörteile werden sicher und fest gehalten. Bei Drücken des Knopfes lösen sich die Teile.

Cliquet réversible à verrouillage :
Les douilles et accessoires ne peuvent plus tomber. Une pression du pouce sur le bouton suffit pour les libérer.

2774JS Flexible Ratchet, reversible
Gelenk-Knarre, verstellbar
Cliquet articulé, réversible



* Renewal Kits → 2753BRK → P318

2774PS Flexible Ratchet, reversible
Gelenk-Knarre, verstellbar
Cliquet articulé, réversible



* Renewal Kits → 2753BRK → P318

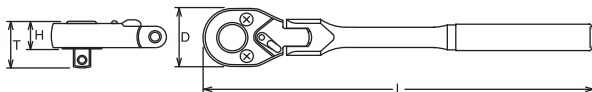

	D (mm)	T (mm)	H (mm)	L (mm)	(g)	(pce.)
2774JS	22	18.7	11.4	116	113	1
2774PS	22	18.7	11.4	116	110	1

1/4" Hand Sockets Hand Steckschlüssel Douilles à main



2774J Flexible Ratchet, reversible
Gelenk-Knarre, verstellbar
Cliquet articulé, réversible

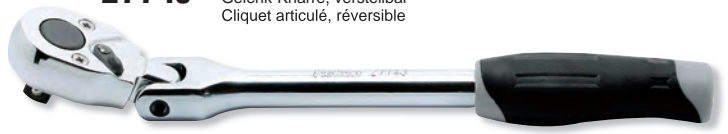

2774P Flexible Ratchet, reversible
Gelenk-Knarre, verstellbar
Cliquet articulé, réversible



2774N Flexible Ratchet, reversible
Gelenk-Knarre, verstellbar
Cliquet articulé, réversible

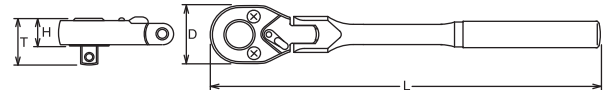

	D (mm)	T (mm)	H (mm)	L (mm)	(g)	(pcs.)
2774J	22	18.7	11.4	161	130	1
2774P	22	18.7	11.4	161	126	1
2774N	22	18.7	11.4	161	130	1



* Renewal Kits -> 2755RK -> P319

2755 Ratchet Adaptor
Aufsteckknarre
Cliquet adaptable

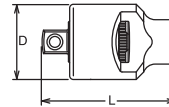

	D (mm)	L (mm)	(g)	(pcs.)
2755	26	40	80	10

2756 Quick Spinner
Rändel-Drehscheibe
Lanceur

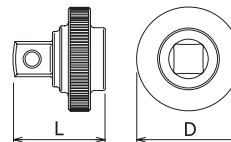

	D (mm)	L (mm)	(g)	(pcs.)
2756	22	20	19	10

2762 Flexible Extension Bar
Biegsame Verlängerung
Rallonge flexible

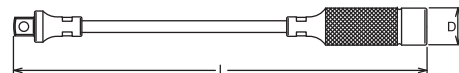

	D (mm)	L (mm)	(g)	(pcs.)
2762	13	300	90	2

2120 Magnetic Head
Magnetkopf
Tête aimantée

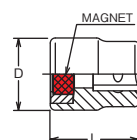

	D (mm)	L (mm)	(g)	(pcs.)
2120	14.3	17.5	21	10

Z-SERIES
HAND
TITANIUM
ACCESSORIES
SCREWDRIVERS
IMPACT
SLEEVE-DRIVE
PROTECTOR
INDUSTRIAL
AUTOMOTIVE
MOTORCYCLE
CONSTRUCTION
SPARE PART

Hand Sockets Hand Steckschlüssel Douilles à main

1/4"

Z-SERIES
HAND
TITANIUM
SCREWDRIVERS
ACCESSORIES
IMPACT
SLEEVE-DRIVE
PROTECTOR
INDUSTRIAL
AUTOMOTIVE
MOTORCYCLE
CONSTRUCTION
SPARE PART

2760 Extension Bars Verlängerungen Rallonges

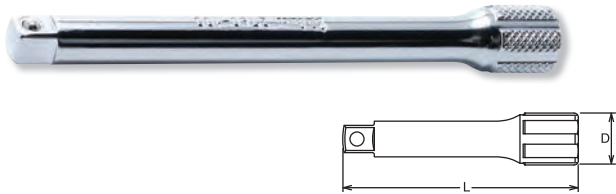

	D (mm)	L (mm)	(g)	(pcs.)
2760-28	12.3	28	14	10
2760-50	12.3	50	23	10
2760-75	12.3	75	35	10
2760-100	12.3	100	44	10
2760-150	12.3	150	63	10
2760-200	12.3	200	83	10
2760-250	12.3	250	103	10
2760-300	12.3	300	122	2
2760-350	12.3	350	145	2
2760-400	12.3	400	160	2
2760-600	12.3	600	240	2

PK2760/6 Extension Set in Plastic Box Verlängerungen in Kunststoffkassette Jeu de rallonges en boîte plastique



PK2760/6	6 Pieces Set/△=430g
PLASTIC TRAY	
Extension Bars	
2760 Extension Bars 28, 50, 100, 150, 200, 250	

Rotation and general handling of extensions with oily hands is greatly improved with the **Koken** developed 6 point knurling. Also the **Koken** 6 point knurling stops the extensions from rolling around the work area.

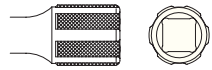

Durch die von **Koken** entwickelte 6 fache Rändelung wird die Handhabung deutlich erleichtert. Außerdem wird das Herumrollen der Verlängerungen wirksam verhindert.

La manipulation des rallonges est grandement facilitée par le profil moleté développé par **Koken**. Ce même profil empêche le roulement intempesitif des rallonges sur le plan de travail.

2763 Wobble-Fix Extension Bars Winkel-Verlängerungen Rallonges angulaires

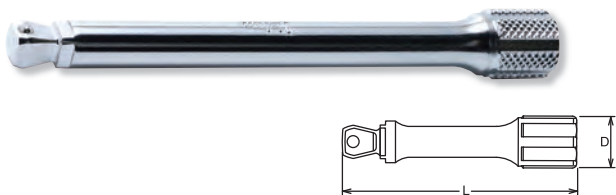

	D (mm)	L (mm)	(g)	(pcs.)
2763-28	12.3	28	14	10
2763-50	12.3	50	23	10
2763-75	12.3	75	33	10
2763-100	12.3	100	43	10
2763-150	12.3	150	62	10
2763-200	12.3	200	80	10
2763-250	12.3	250	100	10

PK2763/6 Wobble-Fix Extension Bars in Plastic Box Winkel-Verlängerungen in Kunststoffkassette Jeu de rallonges angulaires en boîte plastique



PK2763/6	6 Pieces Set/△=420g
PLASTIC TRAY	
Extension Bars	
2763 Wobble-Fix Extension Bars 28, 50, 100, 150, 200, 250	

Wobble-Fix Extension Bar

Two way usage

- In a fixed position, as a normal extension bar
- In a half-fixed position, as a flexible extension bar providing a 15° angle operation

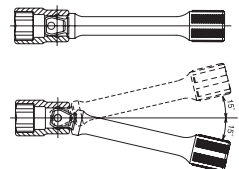

Winkel-Verlängerungen

Winkelverlängerungen lassen sich in zwei Einstellungen verwenden

- voll eingesteckt und starr,
- halb eingesteckt, mit einem Arbeitswinkel von 15°.

Rallonges angulaires

Deux utilisations possibles

- comme rallonge normale, dans une position fixe
- comme une rallonge angulaire avec une possibilité d'inclinaison jusqu'à 15°

⚠ The Wobble-Fix Extension Bar has less strength than normal extension bar due to its specific design with a reduced square drive. Make sure to use it correctly.

Die Wobble-Fix Verlängerungen haben aufgrund ihrer speziellen Konstruktion mit einem reduzierten Vierkantantrieb eine geringere Festigkeit als eine normale Verlängerung. Achten Sie darauf, sie richtig zu verwenden.

La barre d'extension wobble-fix est moins résistante qu'une barre d'extension normale en raison de sa conception spécifique avec un carré d'entraînement réduit. Veuillez à l'utiliser correctement.

2768J Hinge Handle Gelenkgriff Poignée articulée



2768P Hinge Handle Gelenkgriff Poignée articulée

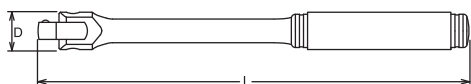

* Renewal Kits → 2768RK → P321

* Renewal Kits → 2768RK → P321

	D (mm)	L (mm)	(g)	(pcs.)
2768J	14	130	73	5
2768P	14	130	70	10

1/4"

Hand Sockets
Hand Steckschlüssel
Douilles à main

2769N	H (mm)	L (mm)	(g)	(pcs.)
150	50	150	73	2
220	120	220	100	2



Plastic or rubber handles are not intended to act as insulation.

Plastik-oder Gummigriffe stellen keinen Isolierschutz dar.

Les poignées en plastique ou en caoutchouc ne garantissent aucune isolation électrique.

2769N-150 / -220

Spin Type Handle
Drehgriff
Poignée emmanchée

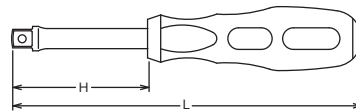

WOBBLE-FIX
EXTENSION BAR



2769NWF	H (mm)	L (mm)	(g)	(pcs.)
150	50	150	73	2
220	120	220	100	2

2769NWF-150 / -220

Spin Type Handle(Wobble-Fix)
Drehgriff, Wobble-Fix
Poignée emmanchée, angulaire

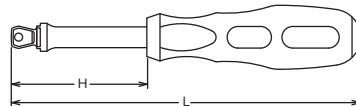

Wobble-Fix Extension Bar

Two way usage:

One for as a flexible extension bar to provide at 15° angle operation, the other for use as a normal extension bar.

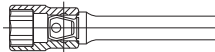

Woble-Fix Verlängerung

Zwei Verwendungsmöglichkeiten:
zum einen als flexible Verlängerung für den Betrieb in einem Winkel von 15°, zum anderen als normale Verlängerung.

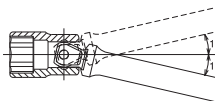

Barre d'extension Woble-Fix

Utilisation double:

l'une comme barre d'extension flexible pour fournir un angle de 15°, l'autre comme barre d'extension normale.

2769H	L (mm)	(g)	(pcs.)
2769H	160	180	5

2769H

Folding Socket Driver
Klapp-Drehgriff
Poignée tournevis articulée

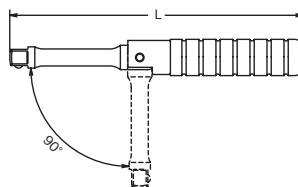
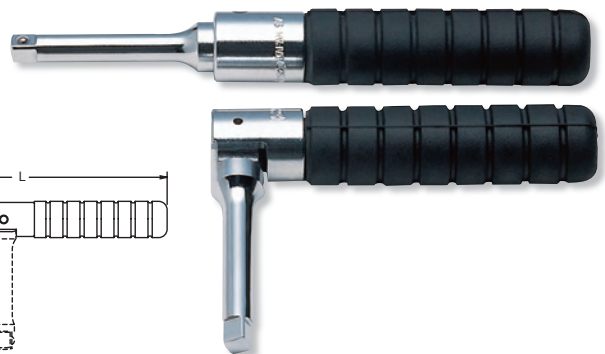

Z-SERIES
HAND
TITANIUM
ACCESSORIES
SCREWDRIVERS
IMPACT
SLEEVE-DRIVE
PROTECTOR
INDUSTRIAL
AUTOMOTIVE
MOTORCYCLE
CONSTRUCTION
SPARE PART

Z-SERIES
HAND
TITANIUM
SCREWDRIVERS ACCESSORIES
IMPACT
SLEEVE-DRIVE
PROTECTOR
INDUSTRIAL
AUTOMOTIVE
MOTORCYCLE
CONSTRUCTION
SPARE PART

2770 Universal Joint
Gelenk-Einsatz
Cardan universel



	L (mm)	(g)	(pcs.)
2770	33	20	10

2771 Universal Joint
Gelenk-Einsatz
Joint articulé



	L (mm)	(g)	(pcs.)
2771	31	20	10



2780 Speed Handle
Winde
Vilebrequin

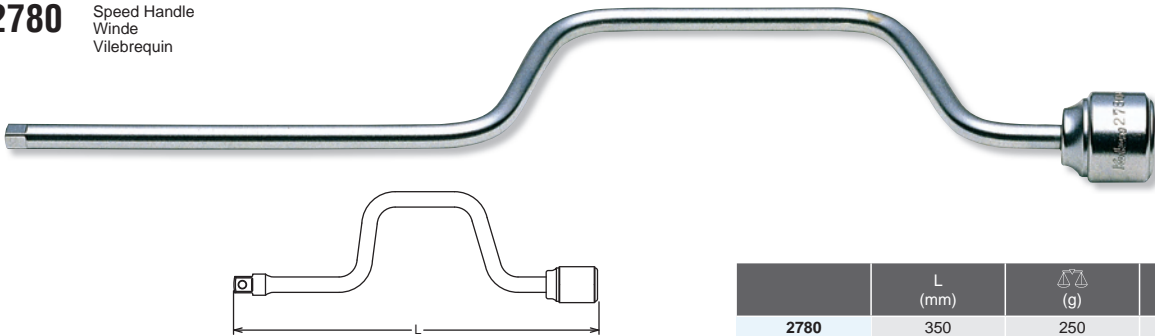

	L (mm)	(g)	(pcs.)
2780	350	250	1

2785 T-Handle
T-Griff
Poignée coulissante

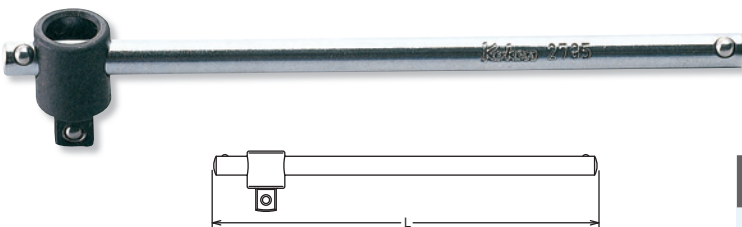

	L (mm)	(g)	(pcs.)
2785	115	36	10

2233A Adaptor
Verbindungsstück
Augmentateur



	(sq.)	(sq.)	L (mm)	(g)	(pcs.)
2233A	1/4"	3/8"	22	16	10

ESH2001 16 Pieces Set/△△=630g	
METAL CASE:W160xH100xT28mm	
Sockets	Accessories
2410M Surface Drive Sockets 4, 5, 5.5, 6, 7, 8, 9, 10, 11, 12, 13	2753J 2763-50 2760-150 2770 2785

ESH2001 Socket Set
Steckschlüssel Satz
Jeu de clés à douille



ENH2003 26 Pieces Set/△△=980g	
METAL CASE:W310xH86xT40mm	
Sockets	Accessories
2400M 6-pt. Sockets 5.5, 6, 7, 8, 9, 10, 11, 12, 13, 14 108P PH Bits 1, 2 108S Slotted Bits 4, 6, 8 108H Hex Bits 3, 4, 5, 6	2753J 2760-50 2760-150 2769N-150 2770 2785 2137

ENH2003 Socket Set
Steckschlüssel Satz
Jeu de clés à douille



2251M 17 Pieces Set/△△=725g	
METAL CASE:W192xH122xT30mm	
Sockets	Accessories
2400M 6-pt. Sockets 4, 4.5, 5, 5.5, 6, 7, 8, 9, 10, 11, 13	2753J 2760-50 2760-150 2768J 2770 2785

2251M / 2251A Socket Set
Steckschlüssel Satz
Jeu de clés à douille



2251A 15 Pieces Set/△△=700g	
METAL CASE:W192xH122xT30mm	
Sockets	Accessories
2400A 6-pt. Sockets 3/16, 7/32, 1/4, 9/32, 5/16, 11/32, 3/8, 7/16, 1/2	2753J 2760-50 2760-150 2768J 2770 2785

2258M Socket Set
Steckschlüssel Satz
Jeu de clés à douille

2258M 31 Pieces Set/△△=965g	
METAL CASE:W240xH100xT32mm	
Sockets	Accessories
2400M 6-pt. Sockets 4, 4.5, 5, 5.5, 6, 7, 8, 9, 10, 11, 13 2000.28 Bit Sockets 1, 2, 3 2005.25 Bit Sockets 4, 6 2010M.25 Bit Sockets 3, 4, 5, 6, 8 2025.28 Bit Sockets T10, T15, T20, T25, T30	2753J 2760-100 2769N-150 2770 2785



Hand Sockets Hand Steckschlüssel Douilles à main

1/4"

Z-SERIES

HAND

TITANIUM

SCREWDRIVERS ACCESSORIES

IMPACT

SLEEVE-DRIVE

PROTECTOR

INDUSTRIAL

AUTOMOTIVE

MOTORCYCLE

CONSTRUCTION

SPARE PART

2259M

Socket Set
Steckschlüssel Satz
Jeu de clés à douille



2263A

Socket Set
Steckschlüssel Satz
Jeu de clés à douille



2275

Socket Set
Steckschlüssel Satz
Jeu de clés à douille



2276

Socket Set with Bits and Accessories
Bit Satz mit Zubehör
Jeu d'embouts et avec accessoires



2277

Socket Set
Steckschlüssel Satz
Jeu de clés à douille



2259M		31 Pieces Set/△=991g	
METAL CASE:W240xH100xT32mm			
Sockets		Accessories	
	2400M 6-pt. Sockets 4, 4.5, 5, 5.5, 6, 7, 8, 9, 10, 11, 13		2774JS
	2000.28 Bit Sockets 1, 2, 3		2760-100
	2005.25 Bit Sockets 4, 6		2769N-150
	2010M.25 Bit Sockets 3, 4, 5, 6, 8		2770
	2025.28 Bit Sockets T10, T15, T20, T25, T30		2785

2263A		29 Pieces Set/△=940g	
METAL CASE:W240xH100xT32mm			
Sockets		Accessories	
	2400A 6-pt. Sockets 1/8, 5/32, 3/16, 7/32, 1/4, 9/32, 5/16, 11/32, 3/8, 7/16, 1/2		2753N
	2000.28 Bit Sockets 1, 2, 3		2760-100
	2010A.25 Bit Sockets 1/8, 5/32, 3/16, 7/32, 1/4, 9/32, 5/16		2769N-150
	2025.28 Bit Sockets T10, T15, T20, T25, T30		2770
			2785

2275		19 Pieces Set/△=880g	
METAL CASE:W192xH122xT30mm			
Sockets		Accessories	
	2400M 6-pt. Sockets 5.5, 6, 7, 8, 10, 12, 13		2753J
	2000.28 Bit Sockets 1, 2, 3		2763-50
	2005.25 Bit Sockets 6, 8		2769N-150
	2010M.25 Bit Sockets 3, 4, 5, 6		





2276		19 Pieces Set/△=640g	
METAL CASE:W192xH122xT30mm			
Bits		Accessories	
	108P PH Bits 1, 2, 3		2753PS
	108S Slotted Bits 4, 5, 6		2769N-150
	108H Hex Bits 3, 4, 5, 6		2137
	108T TORX® Bits T10, T15, T20, T25, T27, T30		

2277		21 Pieces Set/△=1,240g	
METAL CASE:W310xH86xT50mm			
Sockets		Accessories	
	2400M 6-pt. Sockets 5.5, 6, 7, 8, 9, 10, 11, 12, 13		2753J
	2300M 6-pt. Deep Sockets 5.5, 6, 7, 8, 9, 10, 11, 12, 13		2763-75
			2769N-150

1/4"

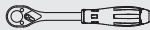

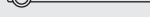

Hand Sockets
Hand Steckschlüssel
Douilles à main

Z-SERIES
HAND
TITANIUM
ACCESSORIES
SCREWDRIVERS
IMPACT
SLEEVE-DRIVE
PROTECTOR
INDUSTRIAL
AUTOMOTIVE
MOTORCYCLE
CONSTRUCTION
SPARE PART

P2201AM		25 Pieces Set/△=800g	
PLASTIC CASE:W245xH120xT45mm			
Sockets	Accessories		
<p>2400M 6-pt. Sockets 4, 5, 5.5, 6, 7, 8, 9, 10, 11, 12, 13</p> <p>2400A 6-pt. Sockets 3/16, 7/32, 1/4, 9/32, 5/16, 11/32, 3/8, 7/16, 1/2</p>		<p>2753J</p>	
		<p>2760-100</p>	
		<p>2769N-150</p>	
		<p>2770</p>	
		<p>2785</p>	



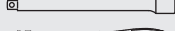
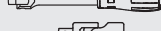

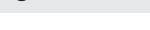
P2201AM Socket Set
Steckschlüssel Satz
Jeu de clés à douille



P2251M		18 Pieces Set/△=770g	
PLASTIC CASE:W245xH120xT45mm			
Sockets	Accessories		
<p>2400M 6-pt. Sockets 4, 4.5, 5, 5.5, 6, 7, 8, 9, 10, 11, 12, 13</p>		<p>2753J</p>	
		<p>2760-50</p>	
		<p>2760-150</p>	
		<p>2768J</p>	
		<p>2770</p>	
		<p>2785</p>	

P2251M Socket Set
Steckschlüssel Satz
Jeu de clés à douille

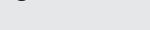

P2258M		31 Pieces Set/△=860g	
PLASTIC CASE:W245xH120xT45mm			
Sockets	Accessories		
<p>2400M 6-pt. Sockets 4, 5, 5.5, 6, 7, 8, 9, 10, 11, 12, 13</p>		<p>2753J</p>	
<p>2000.28 Bit Sockets 1, 2, 3</p>		<p>2760-100</p>	
<p>2005.25 Bit Sockets 4, 6</p>		<p>2769N-150</p>	
<p>2010M.25 Bit Sockets 3, 4, 5, 6, 8</p>		<p>2770</p>	
<p>2025.28 Bit Sockets T10, T15, T20, T25, T30</p>		<p>2785</p>	

P2258M Socket Set
Steckschlüssel Satz
Jeu de clés à douille



ABS Case - PE foam insert
Kunststoffkassette - Weichschaumeinlage
Coffret en ABS - Inserts en mousse

Z-SERIES
HAND
TITANIUM
SCREWDRIVERS ACCESSORIES
IMPACT
SLEEVE-DRIVE
PROTECTOR
INDUSTRIAL
AUTOMOTIVE
MOTORCYCLE
CONSTRUCTION
SPARE PART

3400M / 3400A

6-point Sockets
6-kant Steckschlüssel
Douilles 6-pans

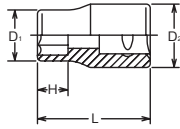

3405M / 3405A

12-point Sockets
12-kant Steckschlüssel
Douilles 12-pans

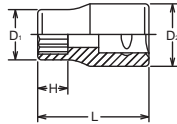

FLAT DRIVE®

Flat drive is designed to guarantee a flat surface contact between the socket and the bolt/nut. The Flat contact reduces wear and allows to transmit a higher torque value. The Flat Drive System is also used for the square drive end as well as the hexagonal or bi-hexagonal openings of the socket.

Das Flat Drive Design sorgt für die optimale Kraftübertragung zwischen den Flächen des Steckschlüssels und der Schraube. Dies erlaubt eine Übertragung von höheren Drehmomenten. Das Flat Drive System findet ebenfalls bei allen Antriebsvierkantente sowie bei 6-kant und 12-kant Profilen Verwendung.

Le profil Flat Drive garantit un contact optimal entre la douille et l'écrou. Ce contact «à plat» réduit l'usure et permet la transmission d'un couple plus élevé. Ce système Flat Drive est utilisé pour tous les carrés conducteurs ainsi que pour toutes nos douilles 6-pans et 12-pans.

RS3400M/12 RS3405M/12

Socket Set on Rail
Steckschlüsselsatz auf Schiene
Jeu de douilles sur rail



RS3400A/9 RS3405A/9

Socket Set on Rail
Steckschlüsselsatz auf Schiene
Jeu de douilles sur rail



3400M 3405M (mm)	D ₁ (mm)	D ₂ (mm)	H (mm)	L (mm)	(g)	(pcs.)
5	8.3	17.3	5	26	20	10
5.5	8.9	17.3	5.5	26	20	10
6	9.9	17.3	6	26	20	10
7	10.8	17.3	6.5	26	20	10
8	12	17.3	7	26	22	10
9	13.3	17.3	7.5	26	23	10
10	14.5	17.3	8	26	24	10
11	15.8	17.3	8.5	26	25	10
12	16.8	17.3	9	26	25	10
13	18	17	9.5	26	24	10
14	19.5	18.5	11	27	31	10
15	20.8	19.5	11.5	28	39	10
16	22	20	12	28	42	10
17	23.3	21.5	12.5	29	51	10
18	24.5	22.5	13	30	51	10
19	25.8	23.5	13.5	30	63	10
20	27	24.5	14	31	75	10
21	28	26	14.5	32	77	10
22	29.5	26.5	15	32	82	10
23	30.8	27.5	15.5	33	95	10
24	32	28.5	16	34	102	10
25	33.3	29.5	16.5	34	115	5
26	34.5	30.5	17	35	129	5

3400A 3405A (inch)	D ₁ (mm)	D ₂ (mm)	H (mm)	L (mm)	(g)	(pcs.)
3/16	8.3	17.3	5	26	20	10
1/4	10.3	17.3	6	26	20	10
9/32	10.8	17.3	6.5	26	20	10
5/16	12	17.3	7	26	22	10
11/32	13.3	17.3	7.5	26	23	10
3/8	13.9	17.3	8	26	23	10
13/32	13.3	17.3	7.5	26	23	10
7/16	15.8	17.3	8.5	26	25	10
1/2	18	17	9.5	26	24	10
9/16	19.5	18.5	11	27	31	10
19/32	20.8	19.5	11.5	28	39	10
5/8	22	20	12	28	42	10
11/16	24.5	22.5	13	30	51	10
3/4	25.8	23.5	13.5	30	63	10
25/32	27	24.5	14	31	75	10
13/16	28	26	14.5	32	77	10
7/8	29.5	26.5	15	32	82	10
15/16	32	28.5	16	34	102	10
1	34.5	30.5	17	35	132	5

RS3400M/12	12 Pieces Set/Rail 300mm	(g)
8, 9, 10, 11, 12, 13, 14, 15, 16, 17, 18, 19		465

RS3405M/12	12 Pieces Set/Rail 300mm	(g)
8, 9, 10, 11, 12, 13, 14, 15, 16, 17, 18, 19		465

RS3400A/9	9 Pieces Set/Rail 200mm	(g)
1/4, 5/16, 3/8, 7/16, 1/2, 9/16, 5/8, 11/16, 3/4		333

RS3405A/9	9 Pieces Set/Rail 200mm	(g)
1/4, 5/16, 3/8, 7/16, 1/2, 9/16, 5/8, 11/16, 3/4		333

3410M (mm)	D ₁ (mm)	D ₂ (mm)	H (mm)	L (mm)	(g)	(pcs.)
5.5	8.9	17.3	5.5	26	20	10
6	9.9	17.3	6	26	20	10
7	10.8	17.3	6.5	26	20	10
8	12	17.3	7	26	22	10
9	13.3	17.3	7.5	26	23	10
10	14.5	17.3	8	26	24	10
11	15.8	17.3	8.5	26	25	10
12	16.8	17.3	9	26	25	10
13	18	17	9.5	26	24	10
14	19.5	18.5	11	27	31	10
15	20.8	19.5	11.5	28	39	10
16	22	20	12	28	42	10
17	23.3	21.5	12.5	29	51	10
18	24.5	22.5	13	30	51	10
19	25.8	23.5	13.5	30	63	10
20	27	24.5	14	31	75	10
21	28	26	14.5	32	77	10
22	29.5	26.5	15	32	82	10
23	30.8	27.5	15.5	33	95	10
24	32	28.5	16	34	102	10



3410M

Surface Drive Sockets
Surface Drive Steckschlüssel
Douilles, Surface Drive

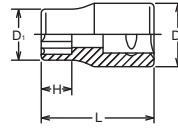

SURFACE DRIVE

Surface drive sockets are designed to retain contact with the flat sides of the nut in order to transmit high torque and reduce nut wear. These sockets are ideal for using on polished nuts, aluminum nuts and nuts with worn out points.

Das Profil unserer Surface-Drive Steckschlüssel greift die Schraube an deren Flächen. Dies sichert eine höhere Kraftübertragung und verhindert ein Durchrutschen des Steckschlüssels. Diese Steckschlüssel eignen sich besonders für polierte Schrauben, Aluminium Schrauben und Schrauben bei denen die Ecken bereits abgerundet sind.

Notre profil Surface Drive assure le contact entre la douille et les plats de l'écrou. Ceci réduit l'usure et permet la transmission d'un couple plus élevé. C'est une solution idéale pour les écrous polies, celles en aluminium ou arrondies.

RS3410M/12	12 Pieces Set/Rail 300mm	(g)
8, 9, 10, 11, 12, 13, 14, 15, 16, 17, 18, 19		468

RS3410M/12

Socket Set on Rail
Steckschlüsselsatz auf Schiene
Jeu de douilles sur rail



3400W 3405W (W)	D ₁ (mm)	D ₂ (mm)	H (mm)	L (mm)	(g)	(pcs.)
1/8	13.3	17.3	7.5	26	22	10
3/16	15.8	17.3	8.5	26	25	10
1/4	18	17	9.5	26	24	10
5/16	20.8	19.5	11.5	28	39	10
3/8	24.5	22.5	13	30	51	10
7/16	28	26	14.5	32	81	10
1/2	30.8	27.5	15.5	33	103	10
9/16	34.5	30.5	17	35	128	5

3400W

6-point Whitworth Sockets
6-kant Steckschlüssel, Whitworth
Douilles à 6-pans Whitworth

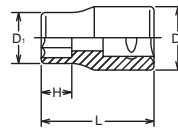

3405W

12-point Whitworth Sockets
12-kant Steckschlüssel, Whitworth
Douilles à 12-pans Whitworth

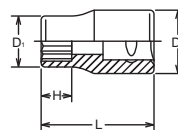

RS3400W/7	7 Pieces Set/Rail 200mm	(g)
1/8, 3/16, 1/4, 5/16, 3/8, 7/16, 1/2		389

RS3400W/7

Socket Set on Rail
Steckschlüsselsatz auf Schiene

RS3405W/7

Socket Set on Rail
Steckschlüsselsatz auf Schiene

RS3405W/7	7 Pieces Set/Rail 200mm	(g)
1/8, 3/16, 1/4, 5/16, 3/8, 7/16, 1/2		389



BS W



BS - W	BS	3/16BS	1/4BS	5/16BS	3/8BS	7/16BS	1/2BS	9/16BS	5/8BS	11/16BS	3/4BS	7/8BS
	W	1/8W	3/16W	1/4W	5/16W	3/8W	7/16W	1/2W	9/16W	5/8W	11/16W	3/4W
S	(ref. mm)	8.64	11.30	13.34	15.24	18.03	20.83	23.37	25.65	27.94	30.48	33.35

3415M / 3415A

Double 4-point Sockets
Doppelvierkant Steckschlüssel
Douilles 4-pans, doubles

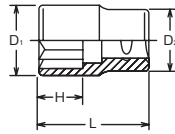

3425

TORX® Sockets
TORX® Steckschlüssel
Douilles TORX®

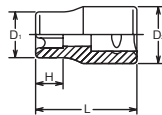

RS3425/9

Socket Set on Rail
Steckschlüsselsatz auf Schiene
Jeu de douilles sur rail



RSX425/14

Socket Set on Rail
Steckschlüsselsatz auf Schiene
Jeu de douilles sur rail



TORX® (E)

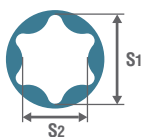

E	E4	E5	E6	E7	E8	E10	E11	E12	E14	E16	E18	E20	E22	E24	E26	E28	E30	E32
S ₁ (ref. mm)	3.7	4.6	5.6	6.1	7.4	9.3	9.9	11.0	12.8	14.6	16.5	18.3	20.1	22.0	23.7	25.5	27.3	29.0
S ₂ (ref. mm)	2.7	3.3	4.0	4.3	5.3	6.8	7.1	7.9	9.2	10.5	11.9	13.2	14.8	15.7	17.5	18.3	20.0	21.3

3400LH

LHSTIX® Sockets
Steckschlüssel mit LHSTIX® Profil
Douilles au profil LHSTIX®

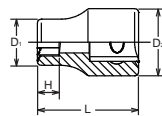

RS3400LH/7

Socket Set on Rail
Steckschlüsselsatz auf Schiene
Jeu de douilles sur rail



LHSTIX®

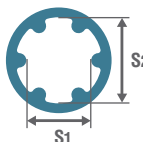

LH-S	LH-5S	LH-6S	LH-8S	LH-10S	LH-12S	LH-14S	LH-16S
S ₁ (ref. mm)	5.6	6.8	9.0	11.3	13.6	15.8	18.1
S ₂ (ref. mm)	7.5	9.0	12.0	15.0	18.0	21.0	24.0

3415M (mm)	D ₁ (mm)	D ₂ (mm)	H (mm)	L (mm)	(g)	(pcs.)
5.5	10.8	17.4	5.5	26	21	10
6	12	17.3	6	26	26	10
7	13.3	17.4	6.5	26	26	10
8	14.5	17.3	7	26	26	10
10	16.8	17.3	8	26	27	10
12	20.8	19.5	9	27	43	10
13	21.9	20	9.5	27	46	10

3415A (inch)	D ₁ (mm)	D ₂ (mm)	H (mm)	L (mm)	(g)	(pcs.)
1/4	12	17.3	6	26	24	10
5/16	14.5	17.3	7	26	26	10
11/32	15.8	17.3	7.5	26	27	10
3/8	16.8	17.3	8	26	27	10
7/16	19.5	18.5	8.5	27	37	10
1/2	22	20	9.5	27	46	10

3425 (E)	D ₁ (mm)	D ₂ (mm)	H (mm)	L (mm)	(g)	(pcs.)
E 4	5.6	17.3	4.6	26	18	10
E 5	7	17.3	5.2	26	20	10
E 6	8.3	17.3	5.4	26	21	10
E 7	8.9	17.3	6.6	26	22	10
E 8	9.9	17.3	7	26	23	10
E10	12	17.3	8.2	26	24	10
E11	13.3	17.3	8.7	26	25	10
E12	14.5	17.3	9.3	26	26	10
E14	15.8	17.3	10.6	26	27	10
E16	18	17	11.8	26	27	10

RS3425/9	9 Pieces Set/Rail 200mm	(g)
E4, E5, E6, E7, E8, E10, E12, E14, E16		239

RSX425/14	14 Pieces Set/Rail 300mm	(g)
2425	1/4"	E4, E5, E6, E7, E8
3425	3/8"	E10, E11, E12, E14
4425	1/2"	E16, E18, E20, E22, E24
		550

3400LH (LH-S)	D ₁ (mm)	D ₂ (mm)	H (mm)	L (mm)	(g)	(pcs.)
5S	10.8	17.3	5	26	20	10
6S	12	17.3	5.6	26	22	10
8S	15.8	17.3	6.8	26	25	10
10S	18	17	8	26	25	10
12S	22	20	9.2	28	42	10
14S	24.5	22.5	10.4	30	51	10
16S	28	26	11.6	32	77	10

RS3400LH/7	7 Pieces Set/Rail 150mm	(g)
5S, 6S, 8S, 10S, 12S, 14S, 16S		315

TORX® is a registered trademark of CAMCAR Innovations.
TORX® ist ein registriertes Markenzeichen der Firma CAMCAR Innovations.
TORX® est une marque déposée de CAMCAR Innovations.

LHSTIX® is a registered trademark of OSG SYSTEM PRODUCTS CO., LTD.
LHSTIX® ist ein registriertes Markenzeichen der Firma OSG SYSTEM PRODUCTS CO., LTD.
LHSTIX® est une marque déposée de OSG SYSTEM PRODUCTS CO., LTD.

3/8"

Hand Sockets
Hand Steckschlüssel
Douilles à main

3450M (mm)	D ₁ (mm)	D ₂ (mm)	H (mm)	L (mm)	(g)	(pcs.)
8	12	17.3	5	26	21	10
10	14.5	17.3	6	26	24	10
11	15.8	17.3	6.5	26	26	10
12	16.8	17.3	7	26	26	10
13	18	17	8	26	28	10
14	19.5	18.5	8.5	27	34	10
15	20.8	19.5	9	27	42	10
16	22	20	9	27	50	10
17	23.3	21.5	9.5	28	62	10
18	24.5	22.5	10.5	29	64	10
19	25.8	23.3	11.5	29	66	10
21	28	26	12	29	85	10
22	29.5	27	12.5	29	90	10
24	32	30	14.5	31	102	10



3450M / 3450A



Nut Grip Sockets **Nut Grip**[®]
Steckschlüssel mit 2-facher Kugelhalterung
Douilles à billes de retenue

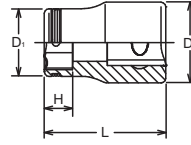

NUT GRIP[®]

Twin balls at the 6-point opening hold bolt/nut tightly for safe and reliable work.

Die zwei Kugeln in der 6-kant Öffnung unserer NUT GRIP Steckschlüssel halten die Schraube sicher im Steckschlüssel. Dies erlaubt ein Arbeiten auch an schwer zugänglichen Stellen.

Les 2 billes dans l'ouverture du 6-pans de la douille retiennent l'écrou de manière sûre et efficace.

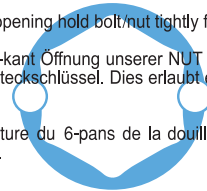

3450A (inch)	D ₁ (mm)	D ₂ (mm)	H (mm)	L (mm)	(g)	(pcs.)
1/4	10.3	17.4	3.5	26	19	10
5/16	12	17.4	5	26	21	10
3/8	13.9	17.4	6	26	24	10
7/16	15.8	17.4	6.5	26	26	10
1/2	18	17	8	26	28	10
9/16	19.5	18.5	8.5	27	34	10
5/8	22	20	9	27	50	10
11/16	24.6	22.5	10.5	29	64	10
3/4	26	23.5	11.5	29	66	10

RS3450M/8	8 Pieces Set/Rail 200mm	(g)
8, 10, 11, 12, 13, 14, 17, 19		310
RS3450M/10	10 Pieces Set/Rail 250mm	(g)
10, 11, 12, 13, 14, 15, 17, 19, 21, 22		500

RS3450A/9	9 Pieces Set/Rail 200mm	(g)
1/4, 5/16, 3/8, 7/16, 1/2, 9/16, 5/8, 11/16, 3/4		360

RS3450M/8 RS3450M/10



Socket Set on Rail
Steckschlüsselsatz auf Schiene
Jeu de douilles sur rail



RS3450A/9



Socket Set on Rail
Steckschlüsselsatz auf Schiene
Jeu de douilles sur rail



3450MH (mm)	D (mm)	H ₁ (mm)	H ₂ (mm)	L (mm)	(g)	(pcs.)
8	12	5	17	26	30	10
10	14.5	6	17	26	30	10
12	16.8	7	17	26	29	10
13	18	8	17	26	28	10
14	19.5	8.5	17	27	32	10
17	23.3	9.5	17	29	41	10



3450MH



Nut Grip Socket wrench with additional hexagon drive
Nut Grip Steckschlüssel mit zusätzlichem Aussensechskant
Douilles à deux billes de retenue avec tête hexagonale supplémentaire

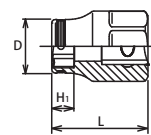

RS3450MH/6	6 Pieces Set/Rail 150mm	(g)
8, 10, 12, 13, 14, 17		230

RS3450MH/6



Socket Set on Rail
Steckschlüsselsatz auf Schiene
Jeu de douilles sur rail



3425 (E)	D ₁ (mm)	D ₂ (mm)	H (mm)	L (mm)	(g)	(pcs.)
E10(2B)	12	17.3	8.2	26	23	10
E12(2B)	14.5	17.3	9.3	26	25	10
E14(2B)	15.8	17.3	10.6	26	26	10
E16(2B)	18.1	17	11.8	26	27	10
E18(2B)	19.5	18.5	12	32	41	10
E20(2B)	21.9	20	14.4	32	52	10

3425 (2B)



TORX[®] Sockets **Nut Grip**[®]
TORX Steckschlüssel mit 2-facher Kugelhalterung
Douilles Torx à deux billes de retenue

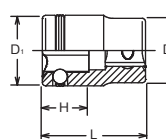

RS3425/4(2B)	4 Pieces Set/Rail 150mm	(g)
E10, E12, E14, E20		150

RS3425/4 (2B)



Socket Set on Rail
Steckschlüsselsatz auf Schiene
Jeu de douilles sur rail



TORX is a registered trademark of CAMCAR Innovations.
TORX ist ein registriertes Markenzeichen der Firma CAMCAR Innovations.
TORX est une marque déposée de CAMCAR Innovations.

Koken TOOL CO., LTD.

071

Z-SERIES
HAND
TITANIUM
ACCESSORIES
SCREWDRIVERS
IMPACT
SLEEVE-DRIVE
PROTECTOR
INDUSTRIAL
AUTOMOTIVE
MOTORCYCLE
CONSTRUCTION
SPARE PART

3300X / 3300XA

6-point Sockets, Semi-Deep
6-kant Steckschlüssel, mittel-lang
Douilles, semi-profondes 6-pans

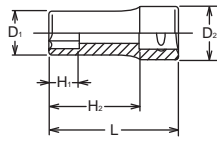

3300X 3305X (mm)	D ₁ (mm)	D ₂ (mm)	H ₁ (mm)	H ₂ (mm)	L (mm)	(g)	(pcs.)
8	12	17.3	9	26.5	40	34	10
9	13	17.3	10	26.5	40	36	10
10	14.5	17.3	11	26.5	40	36	10
11	16	17.2	12	26.5	40	36	10
12	16.8	17.2	13	26.5	40	36	10
13	18	17	14	26.5	40	37	10
14	20	18	16	26.5	40	46	10
15	21	20	16	25.5	40	49	10
16	22	20	17	25.5	40	51	10
17	23.5	22	18	25.5	40	61	10
18	24.5	23	19	24.5	40	68	10
19	25	24	20	24.5	40	75	10

3305X / 3305XA

12-point Sockets, Semi-Deep
12-kant Steckschlüssel, mittel-lang
Douilles, semi-profondes 12-pans

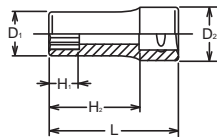

3300XA 3305XA (inch)	D ₁ (mm)	D ₂ (mm)	H ₁ (mm)	H ₂ (mm)	L (mm)	(g)	(pcs.)
1/4	10.3	17.3	7	26.5	40	32	10
5/16	12	17.3	9	26.5	40	34	10
3/8	13.9	17.3	11	26.5	40	36	10
7/16	16	17.2	12	26.5	40	36	10
1/2	18	17	14	26.5	40	37	10
9/16	20	18.5	16	26.5	40	46	10
5/8	22	20	17	25.5	40	51	10
11/16	24.5	22.5	19	24.5	40	68	10
3/4	25	23.5	20	24.5	40	75	10

RS3300X/8 RS3305X/8

Socket Set on Rail
Steckschlüsselsatz auf Schiene
Jeu de douilles sur rail



RS3300X/8	8 Pieces Set/Rail 200mm	(g)
8, 10, 11, 12, 13, 14, 17, 19		405

RS3305X/8	8 Pieces Set/Rail 200mm	(g)
8, 10, 11, 12, 13, 14, 17, 19		405

RS3300XA/9 RS3305XA/9

Socket Set on Rail
Steckschlüsselsatz auf Schiene
Jeu de douilles sur rail



RS3300XA/9	9 Pieces Set/Rail 200mm	(g)
1/4, 5/16, 3/8, 7/16, 1/2, 9/16, 5/8, 11/16, 3/4		460

RS3305XA/9	9 Pieces Set/Rail 200mm	(g)
1/4, 5/16, 3/8, 7/16, 1/2, 9/16, 5/8, 11/16, 3/4		460

3350X

Nut Grip Socket, Semi-Deep **Nut Grip®**
Steckschlüssel mit 2-facher Kugelhalterung, mittel-lang
Douilles à billes de retenue, semi-profondes

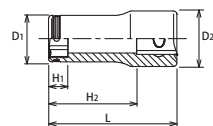

3350X (mm)	D ₁ (mm)	D ₂ (mm)	H ₁ (mm)	H ₂ (mm)	L (mm)	(g)	(pcs.)
8	12	17.4	5	26.5	40	33	10
10	14.5	17.4	6	26.5	40	35	10
12	16.8	17.2	7	26.5	40	40	10
13	18	17	8	26.5	40	45	10
14	19.5	18.5	8.5	26.5	40	48	10

RS3350X/4

Socket Set on Rail
Steckschlüsselsatz auf Schiene
Jeu de douilles sur rail



RS3350X/4	4 Pieces Set/Rail 150mm	(g)
8, 10, 12, 14		165

3300M 3305M (mm)	D ₁ (mm)	D ₂ (mm)	H ₁ (mm)	H ₂ (mm)	L (mm)	(g)	(pcs.)
5.5	8.9	17.3	6.5	41.5	55	37	10
6	9.9	17.3	7	41.5	55	37	10
7	10.6	17.3	8	41.5	55	37	10
8	12	17.3	9	41.5	55	40	10
9	13	17.3	10	41.5	55	42	10
10	14.5	17.3	11	41.5	55	46	10
11	16	17.2	12	41.5	55	51	10
12	16.8	17.2	13	41.5	55	52	10
13	18	17	14	41.5	55	53	10
14	20	18	16	41.5	55	60	10
15	21	20	16	40.5	55	74	10
16	22	20	17	40.5	55	76	10
17	23.5	22	18	40.5	55	93	10
18	24.5	23	19	39.5	55	98	10
19	25	24	20	39.5	55	98	10
20	26	25	21	49.5	65	126	10
21	27	26	22	49.5	65	126	10
22	29	28	23	48.5	65	163	10
23	30	29	24	48.5	65	168	10
24	31	30	25	47.5	65	191	10
25	33	30	26	47.5	65	199	10
26	34	31	27	47.5	65	209	10
27	35	32.5	28	47.5	65	218	10

3300M / 3300A

6-point Deep Sockets
6-kant-Steckschlüssel, lang
Douilles longues 6-pans

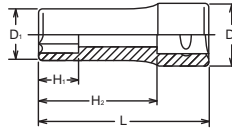

3300A 3305A (inch)	D ₁ (mm)	D ₂ (mm)	H ₁ (mm)	H ₂ (mm)	L (mm)	(g)	(pcs.)
3/16	8.3	17.3	6	41.5	55	35	10
7/32	8.9	17.3	6.5	41.5	55	35	10
1/4	9.9	17.3	7	41.5	55	37	10
5/16	12	17.3	9	41.5	55	40	10
11/32	12.3	17.3	10	41.5	55	41	10
3/8	14	17.3	11	41.5	55	46	10
7/16	16	17.2	12	41.5	55	51	10
1/2	18	17	14	41.5	55	53	10
9/16	20	18	16	41.5	55	60	10
19/32	21	20	16	40.5	55	74	10
5/8	22	20	17	40.5	55	76	10
11/16	23.5	22	18	40.5	55	93	10
3/4	25	24	20	39.5	55	98	10
13/16	27	26	22	49.5	65	126	10
7/8	29	28	23	48.5	65	163	10
15/16	31	30	25	47.5	65	191	10

3305M / 3305A

12-point Deep Sockets
12-kant Steckschlüssel, lang
Douilles longues, 12-pans

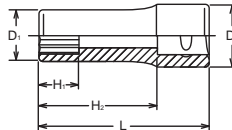

RS3300M/12	12 Pieces Set/Rail 300mm	(g)
8, 9, 10, 11, 12, 13, 14, 15, 16, 17, 18, 19		878

RS3305M/12	12 Pieces Set/Rail 300mm	(g)
8, 9, 10, 11, 12, 13, 14, 15, 16, 17, 18, 19		878

RS3300M/12

Socket Set on Rail
Steckschlüsselsatz auf Schiene
Jeu de douilles sur rail

RS3305M/12



RS3300A/9	9 Pieces Set/Rail 200mm	(g)
1/4, 5/16, 3/8, 7/16, 1/2, 9/16, 5/8, 11/16, 3/4		628

RS3305A/9	9 Pieces Set/Rail 200mm	(g)
1/4, 5/16, 3/8, 7/16, 1/2, 9/16, 5/8, 11/16, 3/4		628

RS3300A/9

Socket Set on Rail
Steckschlüsselsatz auf Schiene
Jeu de douilles sur rail

RS3305A/9



Hand Sockets Hand Steckschlüssel Douilles à main

3/8"

Z-SERIES
HAND
TITANIUM
SCREWDRIVERS ACCESSORIES
IMPACT
SLEEVE-DRIVE
PROTECTOR
INDUSTRIAL
AUTOMOTIVE
MOTORCYCLE
CONSTRUCTION
SPARE PART

3310M  Surface Drive Deep Sockets
Surface Drive Steckschlüssel, lang
Douilles longues, Surface Drive

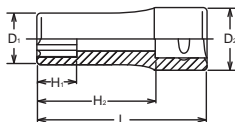

3310M (mm)	D ₁ (mm)	D ₂ (mm)	H ₁ (mm)	H ₂ (mm)	L (mm)	(g)	(pcs.)
6	9.9	17.3	7	41.5	55	37	10
7	10.6	17.3	8	41.5	55	37	10
8	12	17.3	9	41.5	55	40	10
9	13	17.3	10	41.5	55	42	10
10	14.5	17.3	11	41.5	55	46	10
11	16	17.2	12	41.5	55	51	10
12	16.8	17.2	13	41.5	55	52	10
13	18	17	14	41.5	55	53	10
14	20	18	16	41.5	55	60	10
15	21	20	16	40.5	55	74	10
16	22	20	17	40.5	55	76	10
17	23.5	22	18	40.5	55	93	10
18	24.5	23	19	39.5	55	98	10
19	25	24	20	39.5	55	98	10
20	26	25	21	49.5	65	126	10
21	27	26	22	49.5	65	126	10
22	29	28	23	48.5	65	163	10
23	30	29	24	48.5	65	168	10
24	31	30	25	47.5	65	161	10

RS3310M/12  Socket Set on Rail
Steckschlüsselsatz auf Schiene
Jeu de douilles sur rail



RS3310M/12	12 Pieces Set/Rail 300mm	(g)
8, 9, 10, 11, 12, 13, 14, 15, 16, 17, 18, 19		881

3300W  6-point Deep Whitworth Sockets
6-kant Steckschlüssel, lang, Whitworth
Douilles longues à 6-pans Whitworth

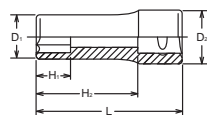

3300W 3305W (W)	D ₁ (mm)	D ₂ (mm)	H ₁ (mm)	H ₂ (mm)	L (mm)	(g)	(pcs.)
1/8	12.3	17.3	10	41.5	55	46	10
3/16	16	17.3	12	41.5	55	55	10
1/4	18	17	14	41.5	55	57	10
5/16	21	20	16	40.5	55	79	10
3/8	24.5	23	19	39.5	55	96	10
7/16	27	26	22	49.5	65	140	10
1/2	30	29	24	48.5	65	193	10
9/16	34	31	27	47.5	65	250	10

3305W  12-point Deep Whitworth Sockets
12-kant Steckschlüssel, Whitworth
Douilles longues à 12-pans Whitworth

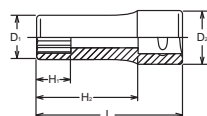

RS3300W/7  Socket Set on Rail
Steckschlüsselsatz auf Schiene
RS3305W/7  Jeu de douilles sur rail



RS3300W/7	7 Pieces Set/Rail 200mm	(g)
1/8, 3/16, 1/4, 5/16, 3/8, 7/16, 1/2		719

RS3305W/7	7 Pieces Set/Rail 200mm	(g)
1/8, 3/16, 1/4, 5/16, 3/8, 7/16, 1/2		719

BS W



BS-W	BS	3/16BS	1/4BS	5/16BS	3/8BS	7/16BS	1/2BS	9/16BS	5/8BS	11/16BS	3/4BS	7/8BS
	W	1/8W	3/16W	1/4W	5/16W	3/8W	7/16W	1/2W	9/16W	5/8W	11/16W	3/4W
S	(ref. mm)	8.64	11.30	13.34	15.24	18.03	20.83	23.37	25.65	27.94	30.48	33.35

Hand Sockets Hand Steckschlüssel Douilles à main

3325 (E)	D ₁ (mm)	D ₂ (mm)	H ₁ (mm)	H ₂ (mm)	L (mm)	(g)	(pcs.)
E 4	5.6	17.3	4.6	41.5	55	29	10
E 5	6.9	17.3	5.2	41.5	55	31	10
E 6	7.9	17.3	5.4	41.5	55	33	10
E 7	8.9	17.3	6.6	41.5	55	36	10
E 8	9.9	17.3	7	41.5	55	39	10
E10	11.8	17.3	8.2	41.5	55	43	10
E11	13	17.3	8.7	41.5	55	50	10
E12	14.5	17.2	9.3	41.5	55	53	10
E14	15.7	17.2	10.6	41.5	55	57	10
E16	18	17	11.8	41.5	55	69	10

RS3325/9	9 Pieces Set/Rail 200mm	(g)
E4, E5, E6, E7, E8, E10, E12, E14, E16		420

3325 TORX® Deep Sockets
TORX® Steckschlüssel, lang
Douilles longues TORX®

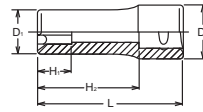

RS3325/9 Socket Set on Rail
Steckschlüsselsatz auf Schiene
Jeu de douilles sur rail



TORX®
(E)

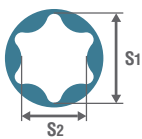

E	E4	E5	E6	E7	E8	E10	E11	E12	E14	E16	E18	E20	E22	E24	E26	E28	E30	E32
S ₁ (ref. mm)	3.7	4.6	5.6	6.1	7.4	9.3	9.9	11.0	12.8	14.6	16.5	18.3	20.1	22.0	23.7	25.5	27.3	29.0
S ₂ (ref. mm)	2.7	3.3	4.0	4.3	5.3	6.8	7.1	7.9	9.2	10.5	11.9	13.2	14.8	15.7	17.5	18.3	20.0	21.3

3350M (mm)	D ₁ (mm)	D ₂ (mm)	H ₁ (mm)	H ₂ (mm)	L (mm)	(g)	(pcs.)
8	12	17.4	5	41.5	55	50	10
10	14.5	17.4	6	41.5	55	54	10
12	16.8	17.2	7	41.5	55	58	10
13	18	17	8	41.5	55	59	10
14	19.5	18.5	8.5	41.5	55	71	10



RS3350M/5	5 Pieces set/Rail 150mm	(g)
8, 10, 12, 13, 14		322

3350M Nut Grip Deep Sockets **Nut Grip®**
Steckschlüssel mit 2-facher Kugelhalterung, lang
Douilles longues à billes de retenue

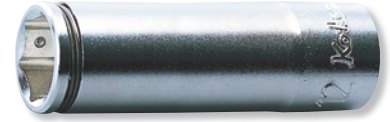
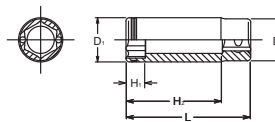

RS3350M/5 Socket Set on Rail
Steckschlüsselsatz auf Schiene
Jeu de douilles sur rail



3300FN (mm)	D ₁ (mm)	D ₂ (mm)	H (mm)	L (mm)	S (mm)	(g)	(pcs.)
8	14.5	17.3	6	53	6.4	38	10
9	16	17.3	7	53	6.8	41	10
10	16.8	17.2	7.5	53	7.2	42	10
11	18	17	8.5	53	8.3	42	10
12	20	18	9	53	8.8	50	10
13	21.1	20	9.5	62	9.4	66	10
14	22	20	10.5	62	10.5	66	10
15	23	22	11	70	11.5	82	10
16	24	23	11.5	70	12	90	10
17	25	24	12.5	80	13	110	10
18	27	25	13	80	13.5	120	10
19	28	26	14	80	14.5	130	10
21	30	27.5	15	80	15.5	170	10
22	32	29.5	16	80	16	180	10
24	34.5	31.5	17	80	17	200	10

RS3300FN/8	8 Pieces Set/Rail 200mm	(g)
9, 10, 11, 13, 14, 16, 17, 19		600

3300FN Flare Nut Sockets
Geschlitzte Steckschlüssel für Überwurfmutter
Douilles à tuyauter

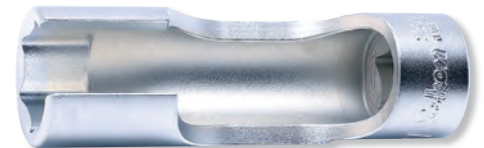
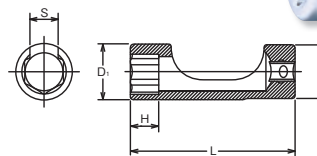

RS3300FN/8 Socket Set on Rail
Steckschlüsselsatz auf Schiene
Jeu de douilles sur rail



Z-SERIES
HAND
TITANIUM
SCREWDRIVERS ACCESSORIES
IMPACT
SLEEVE-DRIVE
PROTECTOR
INDUSTRIAL
AUTOMOTIVE
CONSTRUCTION MOTORCYCLE
SPARE PART

3300M (L120)

6-point Extra Deep Sockets
6-kant Steckschlüssel, extra lang
Douilles extra longues 6-pans



3305M (L120)

12-point Extra Deep Sockets
12-kant Steckschlüssel, extra lang
Douilles extra longues 12-pans

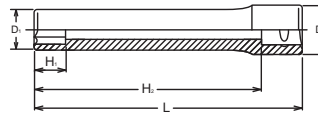

3300M-Size DEEP SOCKET

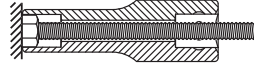

3300M-Size(L120) EXTRA DEEP SOCKET

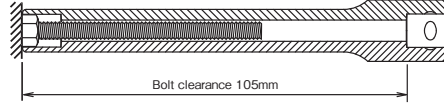

3300M(L120) 3305M(L120) (mm)	D ₁ (mm)	D ₂ (mm)	H ₁ (mm)	H ₂ (mm)	L (mm)	(g)	(pcs.)
8	12	17.3	9	106.5	120	85	10
10	14.5	17.3	11	106.5	120	110	10
12	16.8	17.2	13	106.5	120	116	10
13	18	17	14	106.5	120	155	5
14	20	18	16	106.5	120	166	5

3300M/4-L120 3305M/4-L120

Socket Set
Steckschlüssel Satz
Jeu de clés à douille



3300M/4-L120 4 Pieces Set/△=477g

PLASTIC BAG

Sockets

3300M(L120) 6-point Extra Deep Sockets
8, 10, 12, 14

3305M/4-L120 4 Pieces Set/△=477g

PLASTIC BAG

Sockets

3305M(L120) 12-point Extra Deep Sockets
8, 10, 12, 14

3350M (L120) / 3350A (L120)

Nut Grip Deep Sockets **Nut Grip**[®]
Steckschlüssel mit 2-facher Kugelhalterung, lang
Douilles extra longues à billes de retenue

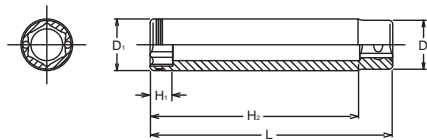

3350M(L120) (mm)	D ₁ (mm)	D ₂ (mm)	H ₁ (mm)	H ₂ (mm)	L (mm)	(g)	(pcs.)
New 8	12	17.3	5	106.5	120	77	10
10	14.5	17.2	6	106.5	120	110	10
12	16.8	17.2	7	106.5	120	116	10

3350A(L120) (inch)	D ₁ (mm)	D ₂ (mm)	H ₁ (mm)	H ₂ (mm)	L (mm)	(g)	(pcs.)
New 7/16	15.8	17.3	6.5	106.5	120	123	10
New 1/2	18	17	8	106.5	120	142	10
New 9/16	20	18.5	8.5	106.5	120	179	10



NUT GRIP[®]

3350M/2-L120

Socket Set
Steckschlüssel Satz
Jeu de clés à douille

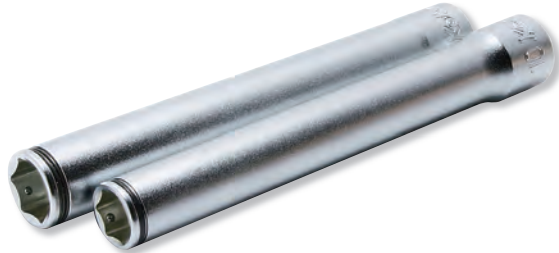

3350M/2-L120 2 Pieces Set/△=230g

PLASTIC BAG

Sockets

3350M(L120) Nut Grip Extra Deep Sockets
10, 12

3440M 3445M (mm)	D ₁ (mm)	D ₂ (mm)	H (mm)	L (mm)	(g)	(pcs.)
8	12	19	7.3	47	50	10
9	13.3	19	7.8	47.5	50	10
10	14.5	19	8.8	48.5	64	10
11	15.8	19	9.8	49.5	66	10
12	17	19	10.3	50	67	10
13	18.3	19	11.3	51	68	10
14	19.5	19	11.3	51	69	10
15	20.8	19	12.8	53.5	70	10
16	22	19	12.8	53.5	77	10
17	23.3	19	13.8	54.5	80	10
18	24.5	19	13.8	54.5	80	10
19	25.8	19	15.8	56.5	84	10
21	28.3	19	16.8	56.5	96	10

3440A 3445A (inch)	D ₁ (mm)	D ₂ (mm)	H (mm)	L (mm)	(g)	(pcs.)
5/16	12	19	7.3	47	50	10
3/8	14	19	8.3	48	64	10
7/16	15.8	19	9.8	49.5	66	10
1/2	18.3	19	11.3	51	68	10
9/16	19.5	19	11.3	51	69	10
5/8	22	19	12.8	53.5	77	10
11/16	24.5	19	13.8	54.5	80	10
3/4	25.8	19	15.8	56.5	84	10

RS3440M/8	8 Pieces Set/Rail 200mm	(g)
8, 10, 11, 12, 13, 14, 17, 19		550

RS3440A/8	8 Pieces Set/Rail 200mm	(g)
5/16, 3/8, 7/16, 1/2, 9/16, 5/8, 11/16, 3/4		570

3445W (W)	D ₁ (mm)	D ₂ (mm)	H (mm)	L (mm)	(g)	(pcs.)
1/8	13.3	19	7.8	47.5	50	10
3/16	15.8	19	9.7	49.5	66	10
1/4	18.3	19	11.3	51	68	10
5/16	20.8	19	12.8	53.5	70	10
3/8	24.5	19	13.8	54.5	80	10
7/16	28.3	19	16.8	57.5	96	10
1/2	30.8	19	17.8	58.5	105	10

RS3445W/7	7 Pieces Set/Rail 200mm	(g)
1/8, 3/16, 1/4, 5/16, 3/8, 7/16, 1/2		570

3440T (E)	D ₁ (mm)	D ₂ (mm)	H (mm)	L (mm)	(g)	(pcs.)
E 6	7.9	19	5.4	44.9	60	10
E 8	9.9	19	7	46.5	63	10
E10	11.8	19	8.2	47.7	63	10
E12	14.5	19	9.3	48.8	68	10
E14	15.7	19	10.6	50.1	68	10
E16	18	19	11.8	51.3	70	10
E18	19.5	19	13	53.5	78	10
E20	22	19	14.4	54.9	81	10

3440M / 3440A

6-point Universal Sockets
6-kant Gelenk-Einsätze
Douilles articulées, 6-pans

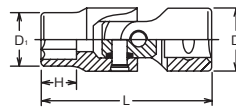

3445M / 3445A

12-point Universal Sockets
12-kant Gelenk-Einsätze
Douilles articulées, 12-pans

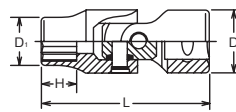

RS3440M/8

Socket Set on Rail
Steckschlüsselsatz auf Schiene
Jeu de douilles sur rail

RS3440A/8



3445W

12-Point Whitworth Universal Socket
12-kant Gelenk-Einsatz, Whitworth
Douille articulées, 12-pans, Whitworth

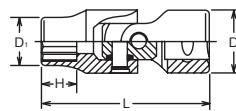

RS3445W/7

Socket Set on Rail
Steckschlüsselsatz auf Schiene
Jeu de douilles sur rail



3440T

TORX® Universal Sockets
TORX® Gelenk-Einsätze
Douilles articulées TORX®

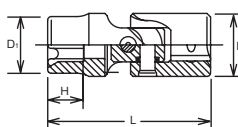

Z-SERIES
HAND
TITANIUM
SCREWDRIVERS
ACCESSORIES
IMPACT
SLEEVE-DRIVE
PROTECTOR
INDUSTRIAL
AUTOMOTIVE
MOTORCYCLE
CONSTRUCTION
SPARE PART

RS3440T/8



Socket Set on Rail
Steckschlüsselsatz auf Schiene
Jeu de douilles sur rail



RS3440T/8	8 Pieces Set/Rail 200mm	(g)
E6, E8, E10, E12, E14, E16, E18, E20		594

TORX® (E)

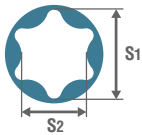

E	E4	E5	E6	E7	E8	E10	E11	E12	E14	E16	E18	E20	E22	E24	E26	E28	E30	E32
S ₁ (ref. mm)	3.7	4.6	5.6	6.1	7.4	9.3	9.9	11.0	12.8	14.6	16.5	18.3	20.1	22.0	23.7	25.5	27.3	29.0
S ₂ (ref. mm)	2.7	3.3	4.0	4.3	5.3	6.8	7.1	7.9	9.2	10.5	11.9	13.2	14.8	15.7	17.5	18.3	20.0	21.3

3441M



Nut Grip Universal Sockets Nut Grip®
Gelenk-Einsätze mit zweifacher Kugelhalterung
Douilles articulées, à billes de retenue

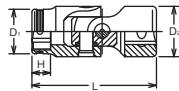

3441M (mm)	D ₁ (mm)	D ₂ (mm)	H (mm)	L (mm)	(g)	(pcs.)
8	12	19	5	46	57	10
10	14.5	19	6	46	58	10
11	15.8	19	6.5	46.5	61	10
12	16.8	19	7	47	58	10
13	18	19	8	48	60	10
14	19.5	19	8.5	49.5	65	10
15	21	19	9	50	69	10
16	22	19	9	50	70	10
17	23.5	19	9.5	51	73	10
18	24.6	19	10.5	51.5	76	10
19	26	19	11.5	52.5	80	10



RS3441M/11



Socket Set on Rail
Steckschlüsselsatz auf Schiene
Jeu de douilles sur rail



RS3441M/11	11 Pieces Set/Rail 300mm	(g)
8, 10, 11, 12, 13, 14, 15, 16, 17, 18, 19		750

3340M-75



Universal Deep Sockets
Gelenk-Steckschlüssel, lange Ausführung
Douilles articulées longues

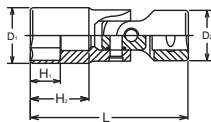

3340M-75 (mm)	D ₁ (mm)	D ₂ (mm)	H ₁ (mm)	H ₂ (mm)	L (mm)	(g)	(pcs.)
8	12	19	9	39	75	82	10
10	14.5	19	11	39	75	87	10
11	15.8	19	12	39	75	87	10
12	17	19	13	39	75	92	10
13	18.3	19	14	36	75	93	10
14	19.5	19	15	35	75	103	10
15	20.8	19	16	35	75	104	10
16	22	19	17	34	75	110	10
17	23.3	19	18	34	75	115	10
18	24.5	19	19	34	75	119	10
19	25.8	19	20	33	75	123	10

RS3340M/8-L75



Socket Set on Rail
Steckschlüsselsatz auf Schiene
Jeu de douilles sur rail



RS3340M/8-L75	8 Pieces Set/Rail 200mm	(g)
8, 10, 11, 12, 13, 14, 17, 19		810

3/8" Hand Sockets Hand Steckschlüssel Douilles à main

3430M (mm)	D (mm)	H (mm)	L (mm)	(g)	(pcs.)
5	19	15.5	62	66	10
6	19	15.5	62	70	10
7	19	15.5	62	72	10
8	19	15.5	62	74	10
10	19	15.5	62	78	10
12	19	15.5	62	85	10

3430M  Universal Hex Sockets
Gelenk-Einsätze für Schrauben mit Innensechskant
Douilles articulées, 6-pans mâle

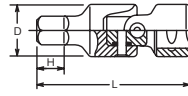

RS3430M/6	6 Pieces Set/Rail 150mm	(g)
5, 6, 7, 8, 10, 12		470

RS3430M/6   Socket Set on Rail
Steckschlüsselsatz auf Schiene
Jeu de douilles sur rail



3117M-125 / -250  Extended Sockets
Schaftsteckschlüssel
Douilles rallongées

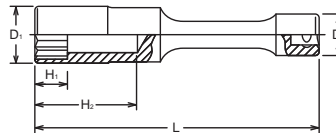

3117M-125 (mm)	D ₁ (mm)	D ₂ (mm)	H ₁ (mm)	H ₂ (mm)	L (mm)	(g)	(pce.)
10	14.5	18	10	44	125	121	1
11	16	18	11	44	125	133	1
12	17	18	12	44	125	133	1
13	18	18	13	44	125	134	1
14	19.5	18	14	44	125	145	1
17	23.5	18	17	44	125	178	1
19	25	18	19	44	125	187	1
21	27	18	21	44	125	195	1
22	29	18	22	44	125	214	1

3117M-250 (mm)	D ₁ (mm)	D ₂ (mm)	H ₁ (mm)	H ₂ (mm)	L (mm)	(g)	(pce.)
10	14.5	18	10	44	250	233	1
11	16	18	11	44	250	241	1
12	17	18	12	44	250	246	1
13	18	18	13	44	250	249	1
14	19.5	18	14	44	250	262	1
17	23.5	18	17	44	250	289	1
19	25	18	19	44	250	298	1
21	27	18	21	44	250	302	1
22	29	18	22	44	250	325	1



Z-SERIES
HAND
TITANIUM
ACCESSORIES
SCREWDRIVERS
IMPACT
SLEEVE-DRIVE
PROTECTOR
INDUSTRIAL
AUTOMOTIVE
MOTORCYCLE
CONSTRUCTION
SPARE PART

Z-SERIES
HAND
TITANIUM
SCREWDRIVERS ACCESSORIES
IMPACT
SLEEVE-DRIVE
PROTECTOR
INDUSTRIAL
AUTOMOTIVE
MOTORCYCLE
CONSTRUCTION
SPARE PART

3000-60 (PH)

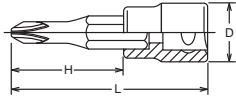
 PH Bit Sockets
Steckschlüssel für Kreuzschlitzschrauben, PH
Douilles tournevis pour vis à empreinte PH





3000 (PH)	D (mm)	H (mm)	L (mm)	 (g)	 (pcs.)
1	18	33.5	60	49	10
2	18	33.5	60	49	10
3	18	33.5	60	49	10
4	18	33.5	60	50	10

3000-50 (PZ)

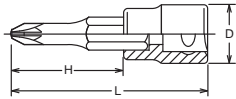
 PZ Bit Sockets
Steckschlüssel für Kreuzschlitzschrauben, PZ
Douilles tournevis pour vis à empreinte PZ









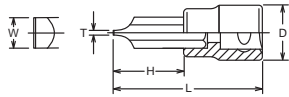
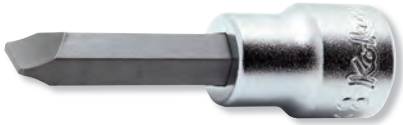







3000-50 (PZ)	D (mm)	H (mm)	L (mm)	 (g)	 (pcs.)
PZ1	18	23.5	50	50	10
PZ2	18	23.5	50	50	10
PZ3	18	23.5	50	50	10

3005-60



 Bit Sockets for Slotted Heads
Steckschlüssel für Schlitzschrauben
Douilles tournevis pour vis à fente



3005	TxW (mm)	D (mm)	H (mm)	L (mm)	 (g)	 (pcs.)
5	1.0x 5.5	18	33.5	60	47	10
8	1.2x 8	18	33.5	60	49	10
10	1.6x10	20	33.5	60	85	10

	 PH	 PZ	 Slotted	 HEX	 HEX (ball point)	 Triple Square (XZN)	 TORX® (T)	 TORX® (TH)	 TORXPLUS® (IP)	 TORXPLUS® (IPR)	 Ribe-CV
1/4"	No.2000 series	No.2000(PZ) series	No.2005 series	No.2010M/A series	No.2011M series	No.2020 series	No.2025 series	No.2025(TH) series	No.2025(IP) series	No.2025(IPR) series	—
3/8"	No.3000 series	No.3000(PZ) series	No.3005 series	No.3010M/A No.3012M/A No.3015M series	No.3011M series	No.3020 series	No.3025 series	No.3025(TH) series	No.3025(IP) series	No.3025(IPR) series	No.3027 series
1/2"	No.4000 series	No.4000(PZ) series	No.4005 series	No.4010M/A No.4012M/A series	—	No.4020 series	No.4025 series	—	No.4025(IP) series	—	No.4027 series

3010M-38 / -62 / -100 / -160 3010A-50

 Inhex Bit Sockets
Steckschlüssel für Innensechskant-Schrauben
 Douilles tournevis pour vis 6-pans creux

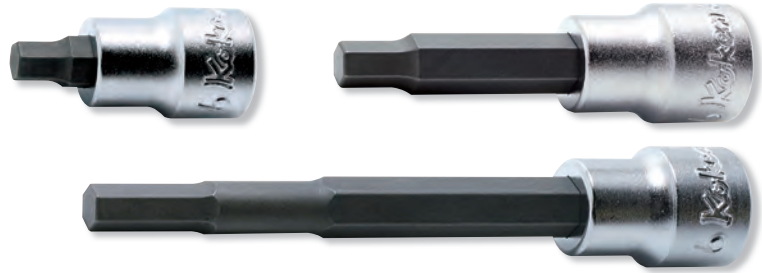
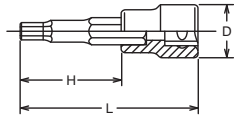

3010M-38 (mm)	D (mm)	H (mm)	L (mm)	(g)	(pcs.)
3	18	11.5	38	27	10
4	18	11.5	38	28	10
5	18	11.5	38	30	10
6	18	11.5	38	31	10
7	18	11.5	38	32	10
8	18	11.5	38	33	10
9	20	11.5	38	47	10
10	20	11.5	38	48	10
11	20	11.5	38	59	10
12	20	11.5	38	60	10
13	22	11.5	38	76	5
14	22	11.5	38	78	5

3010M-62 (mm)	D (mm)	H (mm)	L (mm)	(g)	(pcs.)
3	18	35.5	62	43	10
4	18	35.5	62	45	10
5	18	35.5	62	48	10
6	18	35.5	62	49	10
7	18	35.5	62	50	10
8	18	35.5	62	62	10
9	20	35.5	62	75	10
10	20	35.5	62	76	10
11	20	35.5	62	92	10
12	20	35.5	62	94	10
13	22	35.5	62	107	5
14	22	35.5	62	109	5

3010M-100 (mm)	D (mm)	H (mm)	L (mm)	(g)	(pcs.)
3	18	73.5	100	58	10
4	18	73.5	100	60	10
5	18	73.5	100	63	10
6	18	73.5	100	64	10
7	18	73.5	100	66	10
8	18	73.5	100	69	10
9	20	73.5	100	100	10
10	20	73.5	100	102	10
11	20	73.5	100	129	10
12	20	73.5	100	131	10
13	22	73.5	100	158	5
14	22	73.5	100	160	5

3010M-160 (mm)	D (mm)	H (mm)	L (mm)	(g)	(pcs.)
3	18	133.5	160	84	10
4	18	133.5	160	86	10
5	18	133.5	160	89	10
6	18	133.5	160	90	10
7	18	133.5	160	92	10
8	18	133.5	160	95	10
9	20	133.5	160	125	10
10	20	133.5	160	128	10
11	20	133.5	160	153	10
12	20	133.5	160	157	10
13	22	133.5	160	237	5
14	22	133.5	160	239	5

3010A-50 (inch)	D (mm)	H (mm)	L (mm)	(g)	(pcs.)
1/8	18	23.5	50	35	10
5/32	18	23.5	50	36	10
3/16	18	23.5	50	36	10
7/32	18	23.5	50	38	10
1/4	18	23.5	50	40	10
9/32	18	23.5	50	42	10
5/16	18	23.5	50	44	10
11/32	20	23.5	50	59	10
3/8	20	23.5	50	60	10
7/16	20	23.5	50	74	10
1/2	22	23.5	50	91	5

RS3010M/8-L38	8 Pieces Set/Rail 200mm	(g)
3, 4, 5, 6, 7, 8, 10, 12		322
RS3010M/8-L62	8 Pieces Set/Rail 200mm	(g)
3, 4, 5, 6, 7, 8, 10, 12		490
RS3010M/8-L100	8 Pieces Set/Rail 200mm	(g)
3, 4, 5, 6, 7, 8, 10, 12		645
RS3010A/8-L50	8 Pieces Set/Rail 200mm	(g)
1/8, 5/32, 3/16, 7/32, 1/4, 5/16, 3/8, 1/2		400

RS3010M/8-L38



Socket Set on Rail
Steckschlüsselsatz auf Schiene
Jeu de douilles sur rail

RS3010M/8-L62



RS3010M/8-L100



RS3010A/8-L50



Z-SERIES
HAND
TITANIUM
ACCESSORIES
SCREWDRIVERS
IMPACT
SLEEVE-DRIVE
PROTECTOR
INDUSTRIAL
AUTOMOTIVE
MOTORCYCLE
CONSTRUCTION
SPARE PART

3012M-25

 Inhex Sockets
Steckschlüssel für Innensechskant-Schrauben
Douilles tournevis pour vis 6-pans creux

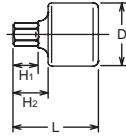

3012M-25 (mm)	D (mm)	H ₁ (mm)	H ₂ (mm)	L (mm)	(g)	(pcs.)
3	18.5	5.5	10	25	22	10
4	18.5	5.5	10	25	22	10
5	18.5	6.5	10	25	22	10
6	18.5	7.5	10	25	23	10
7	18.5	10	-	25	24	10
8	18.5	10	-	25	25	10
10	18.5	10	-	25	27	10
12	18.5	10	-	25	30	10
14	19	10	-	25	30	10
17	19	10	-	25	30	10

3012M-52 / -62 / -75 3012A-52 / -62 / -75

 Inhex Sockets
Steckschlüssel für Innensechskant-Schrauben
Douilles tournevis pour vis 6-pans creux



For Lubrication Service
Schmierdienst-Werkzeuge
Service lubrification-vidange

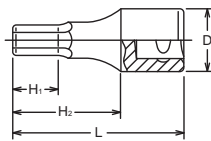

3012M/A are for hand use only.
Do not use with a power or impact wrench.
Bitte nicht auf Schlagschrauber oder anderen
Maschinen gebrauchen.
À ne pas utiliser sur des machines

3012M-52 (mm)	D (mm)	H ₁ (mm)	H ₂ (mm)	L (mm)	(g)	(pcs.)
3	18	10	34	52	35	10
4	18	15.5	34	52	38	10
5	18	15.5	34	52	40	10
6	18	15.5	34	52	42	10
7	18	15.5	34	52	46	10
8	18.5	15.5	34	52	50	10
9	18.5	15.5	34	52	55	10
10	20	15.5	34	52	66	10
11	20	15.5	34	52	72	10
12	20	15.5	34	52	77	10
13	20	15.5	34	52	82	10
14	20	15.5	34	52	89	10

3012M-62 (mm)	D (mm)	H ₁ (mm)	H ₂ (mm)	L (mm)	(g)	(pcs.)
3	18	10	44	62	38	10
4	18	15.5	44	62	40	10
5	18	15.5	44	62	43	10
6	18	15.5	44	62	46	10
7	18	15.5	44	62	53	10
8	18.5	15.5	44	62	58	10
9	18.5	15.5	44	62	63	10
10	20	15.5	44	62	77	10
11	20	15.5	44	62	83	10
12	20	15.5	44	62	90	10
13	20	15.5	44	62	95	10
14	20	15.5	44	62	109	10

3012M-75 (mm)	D (mm)	H ₁ (mm)	H ₂ (mm)	L (mm)	(g)	(pcs.)
3	18	10	57	75	41	10
4	18	15.5	57	75	43	10
5	18	15.5	57	75	48	10
6	18	15.5	57	75	53	10
7	18	15.5	57	75	58	10
8	18.5	15.5	57	75	72	10
9	18.5	15.5	57	75	92	10
10	20	15.5	57	75	114	10
11	20	15.5	57	75	120	10
12	20	15.5	57	75	127	10
13	20	15.5	57	75	132	10
14	20	15.5	57	75	146	10

3012A-52 (inch)	D (mm)	H ₁ (mm)	H ₂ (mm)	L (mm)	(g)	(pcs.)
1/8	18	10	34	52	35	10
5/32	18	15.5	34	52	38	10
3/16	18	15.5	34	52	40	10
7/32	18	15.5	34	52	42	10
1/4	18	15.5	34	52	44	10
9/32	18	15.5	34	52	46	10
5/16	18.5	15.5	34	52	50	10
11/32	18.5	15.5	34	52	55	10
3/8	20	15.5	34	52	65	10
7/16	20	15.5	34	52	72	10
1/2	20	15.5	34	52	82	10
9/16	20	15.5	34	52	89	10

3012A-62 (inch)	D (mm)	H ₁ (mm)	H ₂ (mm)	L (mm)	(g)	(pcs.)
1/8	18	10	44	62	38	10
5/32	18	15.5	44	62	40	10
3/16	18	15.5	44	62	43	10
7/32	18	15.5	44	62	46	10
1/4	18	15.5	44	62	48	10
9/32	18	15.5	44	62	53	10
5/16	18.5	15.5	44	62	58	10
11/32	18.5	15.5	44	62	63	10
3/8	20	15.5	44	62	73	10
7/16	20	15.5	44	62	83	10
1/2	20	15.5	44	62	95	10
9/16	20	15.5	44	62	109	10

3012A-75 (inch)	D (mm)	H ₁ (mm)	H ₂ (mm)	L (mm)	(g)	(pcs.)
1/8	18	10	57	75	41	10
5/32	18	15.5	57	75	43	10
3/16	18	15.5	57	75	48	10
7/32	18	15.5	57	75	53	10
1/4	18	15.5	57	75	53	10
9/32	18	15.5	57	75	58	10
5/16	18.5	15.5	57	75	72	10
11/32	18.5	15.5	57	75	92	10
3/8	20	15.5	57	75	110	10
7/16	20	15.5	57	75	120	10
1/2	20	15.5	57	75	132	10
9/16	20	15.5	57	75	146	10

RS3012M/8-L52 RS3012A /8-L52

 Socket Set on Rail
Steckschlüsselsatz auf Schiene
Jeu de douilles sur rail



RS3012M/8-L52	8 Pieces Set/Rail 200mm	(g)
3, 4, 5, 6, 7, 8, 10, 12		394

RS3012A/8-L52	8 Pieces Set/Rail 200mm	(g)
1/8, 5/32, 3/16, 7/32, 1/4, 5/16, 3/8, 1/2		425

3011M-62 (mm)	D (mm)	H (mm)	L (mm)	(g)	(pcs.)
3	18	35.5	62	45	10
4	18	35.5	62	46	10
5	18	35.5	62	48	10
6	18	35.5	62	49	10
7	18	35.5	62	50	10
8	18	35.5	62	51	10
10	20	35.5	62	66	10
12	20	35.5	62	79	10

3011M-100 (mm)	D (mm)	H (mm)	L (mm)	(g)	(pcs.)
3	18	73.5	100	61	10
4	18	73.5	100	62	10
5	18	73.5	100	64	10
6	18	73.5	100	65	10
7	18	73.5	100	67	10
8	18	73.5	100	68	10
10	20	73.5	100	91	10

3011M-120 (mm)	D (mm)	H (mm)	L (mm)	(g)	(pcs.)
3	18	93.5	120	77	10
4	18	93.5	120	78	10
5	18	93.5	120	80	10
6	18	93.5	120	81	10
7	18	93.5	120	83	10
8	18	93.5	120	84	10

3011M-160 (mm)	D (mm)	H (mm)	L (mm)	(g)	(pcs.)
3	18	133.5	160	87	10
4	18	133.5	160	88	10
5	18	133.5	160	89	10
6	18	133.5	160	91	10
7	18	133.5	160	93	10
8	18	133.5	160	95	10

3015M-62 (mm)	D (mm)	H (mm)	L (mm)	(g)	(pcs.)
3	18	35.5	62	43	10
4	18	35.5	62	45	10
5	18	35.5	62	50	10
6	18	35.5	62	50	10
7	18	35.5	62	50	10
8	18	35.5	62	62	10
10	20	35.5	62	75	10
12	20	35.5	62	95	10

3015M-100 (mm)	D (mm)	H (mm)	L (mm)	(g)	(pcs.)
3	18	73.5	100	60	10
4	18	73.5	100	60	10
5	18	73.5	100	65	10
6	18	73.5	100	65	10
7	18	73.5	100	70	10
8	18	73.5	100	70	10
10	20	73.5	100	105	10
12	20	73.5	100	135	10

RS3015M/8-L62	8 Pieces Set/Rail 200mm	(g)
3, 4, 5, 6, 7, 8, 10, 12		500
RS3015M/8-L100	8 Pieces Set/Rail 200mm	(g)
3, 4, 5, 6, 7, 8, 10, 12		650

3011M-62 / -100 / -120 / -160

Ballpoint Inhex Sockets
Steckschlüssel mit Kugelkopf, für Innensechskant-Schrauben
Douilles tournevis avec tête sphérique pour vis 6-pans creux

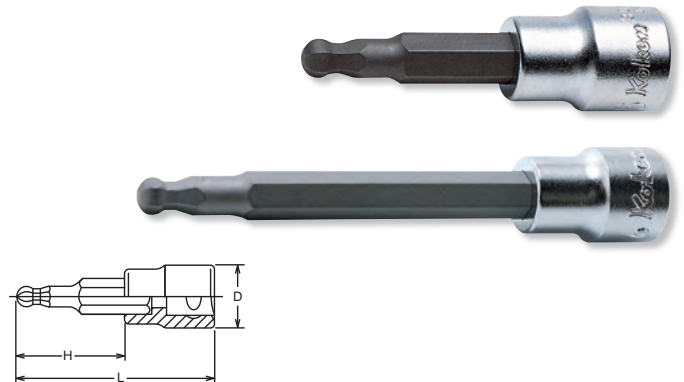

Ballpoint bit sockets have less strength due to the special design. Make sure to use them correctly.
Kugelkopf-Biteinsätze haben aufgrund der speziellen Form eine geringere Festigkeit. Achten Sie darauf, diese richtig zu verwenden.
Les douilles à tête sphérique sont moins résistantes en raison de leur conception spéciale. Veuillez les utiliser correctement.

3015M-62 / -100

Inhex Bit Socket, **Grip Ring**
Steckschlüssel für Innensechskant-Schrauben
Douilles tournevis pour vis 6-pans creux



Grip Ring holds hex screws

Grip Ring bit sockets have less strength due to the special design. Make sure to use them correctly.
Grip Ring Bit-Einsätze haben aufgrund ihrer speziellen Konstruktion eine geringere Festigkeit. Achten Sie darauf, diese richtig zu verwenden.
Les douilles avec bague de préhension sont moins résistantes en raison de leur conception spéciale. Veuillez les utiliser correctement.

RS3015M/8-L62 Socket Set on Rail
RS3015M/8-L100 Steckschlüsselsatz auf Schiene
Jeu de douilles sur rail



3020-38 / -50 / -100 / -120



XZN Bit Sockets
Steckschlüssel für XZN Schrauben
Douilles tournevis pour empreinte XZN

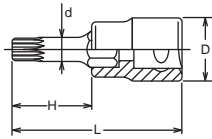

3020-38 (XZN)	D (mm)	d (mm)	H (mm)	L (mm)	(g)	(pcs.)
M 5	18	7.8	11.5	38	32	10
M 6	18	7.8	11.5	38	33	10
M 8	18	7.8	11.5	38	36	10
M10	20	11.9	11.5	38	51	10
M12	20	11.9	11.5	38	52	10
M14	22	13.9	11.5	38	74	10

3020-50 (XZN)	D (mm)	d (mm)	H (mm)	L (mm)	(g)	(pcs.)
M 4	18	7.8	23.5	50	35	10
M 5	18	7.8	23.5	50	37	10
M 6	18	7.8	23.5	50	39	10
M 8	18	7.8	23.5	50	40	10
M10	20	11.9	23.5	50	65	10
M12	20	11.9	23.5	50	69	10
M14	22	13.9	23.5	50	75	10

3020-100 (XZN)	D (mm)	d (mm)	H (mm)	L (mm)	(g)	(pcs.)
M 4	18	7.8	73.5	100	57	10
M 5	18	7.8	73.5	100	59	10
M 6	18	7.8	73.5	100	61	10
M 8	18	7.8	73.5	100	62	10
M10	20	11.9	73.5	100	99	10
M12	20	11.9	73.5	100	103	10
M14	22	13.9	73.5	100	145	5

3020-120 (XZN)	D (mm)	d (mm)	H (mm)	L (mm)	(g)	(pcs.)
M 4	18	7.8	93.5	120	77	10
M 5	18	7.8	93.5	120	79	10
M 6	18	7.8	93.5	120	81	10
M 8	18	7.8	93.5	120	82	10
M10	20	11.9	93.5	120	119	10
M12	20	11.9	93.5	120	123	10
M14	22	13.9	93.5	120	165	5

RS3020/6-L38



Socket Set on Rail
Steckschlüsselsatz auf Schiene
Jeu de douilles sur rail



RS3020/6-L38	6 Pieces Set/Rail 150mm	(g)
M5, M6, M8, M10, M12, M14		308

RS3020/7-L50



Socket Set on Rail
Steckschlüsselsatz auf Schiene
Jeu de douilles sur rail



RS3020/7-L50	7 Pieces Set/Rail 200mm	(g)
M4, M5, M6, M8, M10, M12, M14		400

XZN

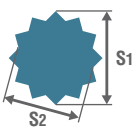

XZN		M4	M5	M6	M8	M10	M12	M14	M16	M18
S ₁	(ref. mm)	3.6	4.8	6.1	7.3	9.7	11.5	13.3	15.7	16.9
S ₂	(ref. mm)	3.1	4.1	5.1	6.1	8.1	9.7	11.2	13.2	14.2

3/8"

Hand Sockets
Hand Steckschlüssel
Douilles à main

3025-38 (T)	D (mm)	H (mm)	L (mm)	(g)	(pcs.)
T 8	18	11.5	38	32	10
T 9	18	11.5	38	32	10
T10	18	11.5	38	32	10
T15	18	11.5	38	33	10
T20	18	11.5	38	33	10
T25	18	11.5	38	33	10
T27	18	11.5	38	33	10
T30	18	11.5	38	33	10
T40	18	11.5	38	34	10
T45	18	11.5	38	37	10
T50	18	11.5	38	49	10
T55	20	11.5	38	57	10

3025-50 (T)	D (mm)	H (mm)	L (mm)	(g)	(pcs.)
T 8	18	23.5	50	36	10
T 9	18	23.5	50	36	10
T10	18	23.5	50	36	10
T15	18	23.5	50	36	10
T20	18	23.5	50	36	10
T25	18	23.5	50	37	10
T27	18	23.5	50	37	10
T30	18	23.5	50	38	10
T40	18	23.5	50	39	10
T45	18	23.5	50	41	10
T50	18	23.5	50	55	10
T55	20	23.5	50	67	10

RS3025/8-L38	8 Pieces Set/Rail 200mm	(g)
T10, T15, T20, T25, T27, T30, T40, T45		300

RS3025/8-L50	8 Pieces Set/Rail 200mm	(g)
T10, T15, T20, T25, T27, T30, T40, T45		320

RS3025/8-L140KE	8 Pieces Set/Rail 200mm	(g)
T20, T25, T27, T30, T40, T45, T50, T55		700

3025-38 / -50 / -140 (T)

TORX® Bit Sockets
TORX® Bit-Steckschlüssel
Douilles tournevis, TORX®

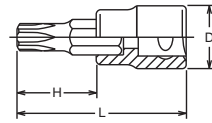

3025-140 (T)	D (mm)	H (mm)	L (mm)	(g)	(pcs.)
T 9	18	113.5	140	75	10
T10	18	113.5	140	75	10
T15	18	113.5	140	75	10
T20	18	113.5	140	75	10
T25	18	113.5	140	76	10
T27	18	113.5	140	76	10
T30	18	113.5	140	77	10
T40	18	113.5	140	78	10
T45	18	113.5	140	80	10
T50	20	113.5	140	94	10
T55	20	113.5	140	106	10

RS3025/8-L38

RS3025/8-L50

RS3025/8-L140KE



Socket Set on Rail
Steckschlüsselsatz auf Schiene
Jeu de douilles sur rail



TORX® (T)

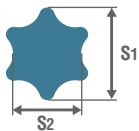

T	T8	T9	T10	T15	T20	T25	T27	T30	T40	T45	T50	T55	T60	T70	T80	T90	T100
S ₁ (ref. mm)	2.3	2.5	2.7	3.3	3.9	4.5	5.0	5.6	6.7	7.9	8.9	11.3	13.3	15.6	17.6	20.0	22.2
S ₂ (ref. mm)	1.7	1.8	2.0	2.3	2.8	3.2	3.6	4.0	4.8	5.6	6.2	8.0	9.5	11.1	12.7	14.2	15.8

3025-50	D (mm)	H (mm)	L (mm)	(g)	(pcs.)
T35	18	23.5	50	39	10

3025-100R (T)	D (mm)	d (mm)	H (mm)	L (mm)	(g)	(pcs.)
T20	18	4	73.5	100	38	10
T25	18	4.6	73.5	100	40	10
T27	18	5.2	73.5	100	42	10
T30	18	5.7	73.5	100	45	10
T40	18	6.8	73.5	100	52	10
T45	18	8	73.5	100	73	10
T50	20	9	73.5	100	80	10
T55	20	11.4	73.5	100	106	10

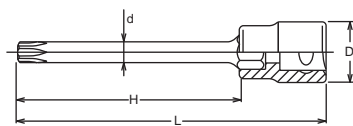

RS3025/8-L100R	8 Pieces Set/Rail 200mm	(g)
T20, T25, T27, T30, T40, T45, T50, T55		490

3025-50-T35

Bit Socket
Bit-Steckschlüssel
Douilles tournevis



3025-100R (T)

TORX® Bit Sockets, round-shaft
TORX® Bit-Steckschlüssel mit Rundschaft
Douilles tournevis TORX® avec manche ronde



RS3025/8-L100R



Socket Set on Rail
Steckschlüsselsatz auf Schiene
Jeu de douilles sur rail



TORX is a registered trademark of CAMCAR Innovations.
TORX ist ein registriertes Markenzeichen der Firma CAMCAR Innovations.
TORX est une marque déposée de CAMCAR Innovations.

Z-SERIES
HAND
TITANIUM
ACCESSORIES
SCREWDRIVERS
IMPACT
SLEEVE-DRIVE
PROTECTOR
INDUSTRIAL
AUTOMOTIVE
MOTORCYCLE
CONSTRUCTION
SPARE PART

3025-50 / -160 (TH)

 Tamper Resistant TORX® Bit Sockets
Tamper Resistant TORX® Bit-Steckschlüssel
Douilles tournevis, Tamper-Resistant TORX®



 Tamper Resistant TORX® Bit Sockets have less strength due to special design. Make sure to use it correctly.



Bitte beachten Sie die geringere Belastbarkeit der Tamper Resistant Torx Steckschlüssel.

Veuillez respecter la moindre capacité inférieure de charge des douilles Tamper Resistant Torx.

3025-50 (TH)	D (mm)	H (mm)	L (mm)	(g)	(pcs.)
T10H	18	23.5	50	37	10
T15H	18	23.5	50	38	10
T20H	18	23.5	50	38	10
T25H	18	23.5	50	38	10
T27H	18	23.5	50	38	10
T30H	18	23.5	50	39	10
T40H	18	23.5	50	40	10
T45H	18	23.5	50	41	10
T50H	18	23.5	50	61	10
T55H	20	23.5	50	61	10

3025-160 (TH)	D (mm)	H (mm)	L (mm)	(g)	(pcs.)
T25H	18	133.5	160	83	10
T27H	18	133.5	160	83	10
T30H	18	133.5	160	84	10
T40H	18	133.5	160	85	10
T45H	18	133.5	160	86	10
T50H	20	133.5	160	128	10
T55H	20	133.5	160	128	10

RS3025/9-HOLE

  Socket Set on Rail
Steckschlüsselsatz auf Schiene
Jeu de douilles sur rail



RS3025/9-HOLE	9 Pieces Set/Rail 200mm	(g)
T10H, T15H, T20H, T25H, T27H, T30H, T40H, T45H, T50H		405

3247

 Bit Socket Set
Schraubendreher-Steckschlüssel Satz
Jeu de douilles de vissage



3247	4 Pieces Set/ =385g
PLASTIC BAG	
Sockets	
 3025.160 Tamper-Resistant TORX® Bit Sockets	T27H, T30H, T40H, T50H

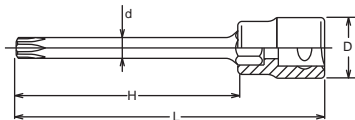

3025-100R (TH)

 Tamper-Resistant TORX® Bit Sockets, round-shaft
Tamper-Resistant TORX® Bit-Steckschlüssel mit Rundschaft
Douilles tournevis, Tamper-Resistant TORX® avec manche ronde



3025-100R (TH)	D (mm)	d (mm)	H (mm)	L (mm)	(g)	(pcs.)
T20H	18	4	73.5	100	38	10
T25H	18	4.6	73.5	100	40	10
T27H	18	5.2	73.5	100	42	10
T30H	18	5.7	73.5	100	45	10
T40H	18	6.8	73.5	100	52	10
T45H	18	8	73.5	100	73	10
T50H	20	9	73.5	100	80	10
T55H	20	11.4	73.5	100	106	10

RS3025/8-L100RH

  Socket Set on Rail
Steckschlüsselsatz auf Schiene
Jeu de douilles sur rail



RS3025/8-L100RH	8 Pieces Set/Rail 200mm	(g)
T20H, T25H, T27H, T30H, T40H, T45H, T50H, T55H		490

3/8"

Hand Sockets
Hand Steckschlüssel
Douilles à main

3025-50 (IP)	D (mm)	H (mm)	L (mm)	(g)	(pcs.)
10IP	18	23.5	50	38	10
15IP	18	23.5	50	38	10
20IP	18	23.5	50	38	10
25IP	18	23.5	50	38	10
27IP	18	23.5	50	40	10
30IP	18	23.5	50	40	10
40IP	18	23.5	50	41	10
45IP	18	23.5	50	41	10
50IP	20	23.5	50	61	10
55IP	20	23.5	50	61	10

RS3025/8-IP	8 Pieces Set/Rail 200mm	(g)
20IP, 25IP, 27IP, 30IP, 40IP, 45IP, 50IP, 55IP		370

RSX025/11-IP	11 Pieces Set/Rail 200mm	(g)
2025.28(IP)	10IP, 15IP, 20IP, 25IP, 27IP	480
3025.50(IP)	30IP, 40IP, 45IP, 50IP	
4025.60(IP)	55IP, 60IP	

1/4" + 3/8" + 1/2"

TORXPLUS® (IP)

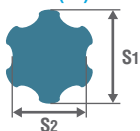

IP	8IP	9IP	10IP	15IP	20IP	25IP	27IP	30IP	40IP	45IP	50IP	55IP	60IP	70IP
S ₁	(ref. mm) 2.3	2.5	2.7	3.3	3.9	4.5	5.0	5.6	6.7	7.9	8.9	11.3	13.3	15.6
S ₂	(ref. mm) 1.8	1.9	2.1	2.5	3.0	3.4	3.9	4.3	5.2	6.2	6.9	9.0	10.4	12.3

3025-50 (IP)

TORXPLUS® Bit Sockets
TORXPLUS® Bit-Steckschlüssel
Douilles tournevis, TORXPLUS®

TORXplus

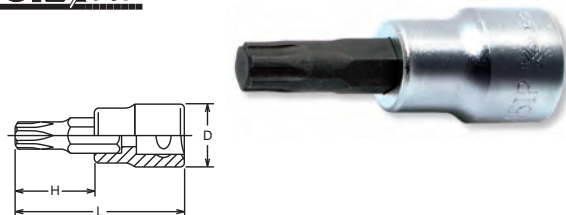

RS3025/8-IP

Socket Set on Rail
Steckschlüsselsatz auf Schiene
Jeu de douilles sur rail



RSX025/11-IP

Socket Set on Rail
Steckschlüsselsatz auf Schiene
Jeu de douilles sur rail



TORXplus®

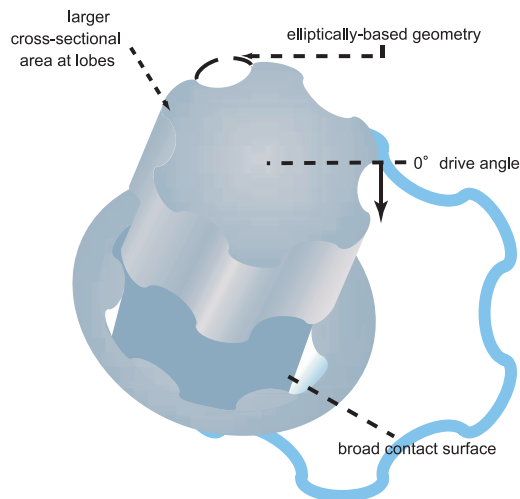
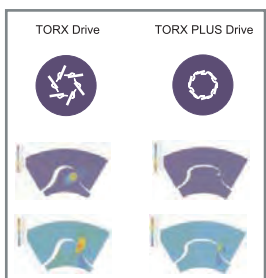
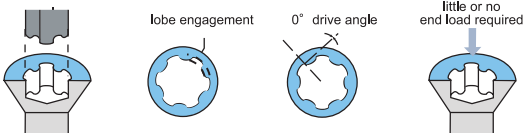

Z-SERIES
HAND
TITANIUM
SCREWDRIVERS ACCESSORIES
IMPACT
SLEEVE-DRIVE
PROTECTOR
INDUSTRIAL
AUTOMOTIVE
CONSTRUCTION MOTORCYCLE
SPARE PART

3025-50 (IPR)

 Tamper-Resistant TORXPLUS® Bit Sockets
Tamper-Resistant TORXPLUS® Bit-Steckschlüssel
Douilles tournevis TORXPLUS® avec trou

TORXplus®



3025-50 (IPR)	D (mm)	H (mm)	L (mm)	(g)	(pcs.)
10IPR	18	23.5	50	38	10
15IPR	18	23.5	50	38	10
20IPR	18	23.5	50	38	10
25IPR	18	23.5	50	38	10
27IPR	18	23.5	50	40	10
30IPR	18	23.5	50	40	10
40IPR	18	23.5	50	41	10
45IPR	18	23.5	50	41	10
50IPR	20	23.5	50	61	10
55IPR	20	23.5	50	61	10

RS3025/9-IPR

 Socket Set on Rail
Steckschlüsselsatz auf Schiene
Jeu de douilles sur rail



RS3025/9-IPR	9 Pieces Set/Rail 200mm	(g)
10IPR, 15IPR, 20IPR, 25IPR, 27IPR, 30IPR, 40IPR, 45IPR, 50IPR		395

RSX025/11-IPR

 Socket Set on Rail
Steckschlüsselsatz auf Schiene
Jeu de douilles sur rail



RSX025/11-IPR	11 Pieces Set/Rail 200mm	(g)
2025.28(IPR)	8IPR, 10IPR, 15IPR, 20IPR, 25IPR, 27IPR, 30IPR	320
3025.50(IPR)	40IPR, 45IPR, 50IPR, 55IPR	

1/4" + 3/8"

TORXPLUS® (IPR)

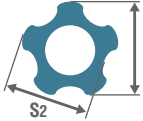

IPR	8IPR	9IPR	10IPR	15IPR	20IPR	25IPR	27IPR	30IPR	40IPR	45IPR	50IPR	55IPR
S ₁ (ref. mm)	2.2	2.4	2.6	3.1	3.6	4.1	4.7	5.2	6.3	7.4	8.4	10.6
S ₂ (ref. mm)	2.0	2.2	2.4	2.8	3.3	3.8	4.3	4.8	5.7	6.7	7.6	9.7

3027-50 / -100

 Bit Sockets for Ribe Screws
Steckschlüsselklingen für Ribe Schrauben
Douilles tournevis pour écrous profil Ribe

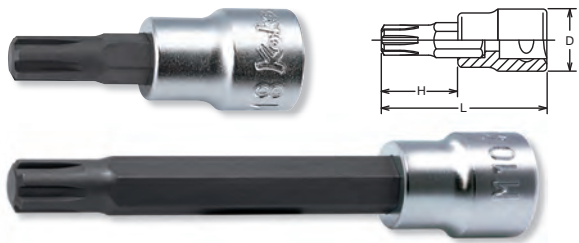

3027-50	D (mm)	H (mm)	L (mm)	(g)	(pcs.)
M 5	18	23.5	50	38	10
M 6	18	23.5	50	38	10
M 7	18	23.5	50	38	10
M 8	18	23.5	50	39	10
M 9	20	23.5	50	40	10
M10	20	23.5	50	40	10
M12	20	23.5	50	41	10

3027-100	D (mm)	H (mm)	L (mm)	(g)	(pcs.)
M 5	18	73.5	100	40	10
M 6	18	73.5	100	42	10
M 8	18	73.5	100	45	10
M10	20	73.5	100	52	10
M12	20	73.5	100	73	10

RS3027/5-L50

 Socket Set on Rail
Steckschlüsselsatz auf Schiene
Jeu de douilles sur rail



RS3027/5-L50	5 Pieces Set/Rail 150mm	(g)
M5, M6, M8, M10, M12		240

Ribe CV

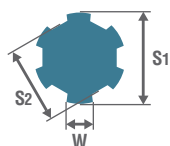

CV	M5	M6	M7	M8	M9	M10	M12	M13	M14	M16
W (ref. mm)	1.2	1.3	1.4	1.8	2.0	2.3	2.6	3.1	3.2	3.6
S ₁ (ref. mm)	5.0	6.0	7.0	8.0	9.0	10.0	12.0	13.0	14.0	16.0
S ₂ (ref. mm)	3.8	4.5	5.0	6.0	7.1	7.4	9.0	11.0	10.4	11.9

3110M (mm)	D (mm)	H (mm)	L (mm)	(g)	(pcs.)
6	18	10	28	30	10
8	18	10	28	30	10
10	18	10	28	33	10
12	18	10	28	37	10

3110A (inch)	D (mm)	H (mm)	L (mm)	(g)	(pcs.)
5/16	18	10	28	30	10
3/8	18	10	28	33	10
1/2	18	10	28	37	10

3110M / 3110A

4-point Male Sockets
Öldienst-Steckschlüssel
Douilles mâles 4-pans

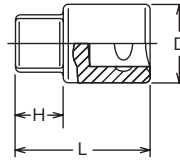

3119 (mm)	T ₁ x T ₂ (mm)	D ₁ (mm)	D ₂ (mm)	d (mm)	L (mm)	(g)	(pcs.)
3 x 5	3 x 5	17	17.3	11	30	30	10
5.5 x 6	5.5 x 6	21	19.5	14	33	45	10



For Wing Bolt
Für Flügelschrauben
Pour écrous à oreilles

For Drain Plug in Radiator
Für Kühler-Ablasschrauben
Pour le vidange du radiateur

3119

Wing Bolt Socket
Steckschlüssel für Flügelschrauben
Douilles pour écrous à oreilles

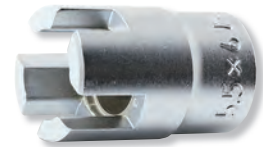
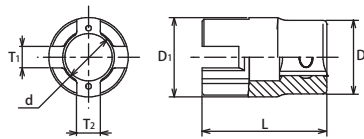

3137	D ₁ (mm)	D ₂ (mm)	L (mm)	(g)	(pcs.)
3137	13	16.5	30	30	10

For DIN3126 C6.3 Bits
Für DIN3126 C6.3 Bits
Pour DIN3126 C6.3 Embouts

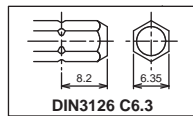

3137

Bit Holder
Klingenhalter
Porte-embouts

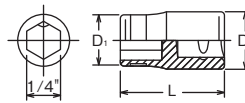

3138	D ₁ (mm)	D ₂ (mm)	L (mm)	(g)	(pcs.)
3138	16	18	38	55	10

For DIN3126 C8 Bits
Für DIN3126 C8 Bits
Pour DIN3126 C8 Embouts

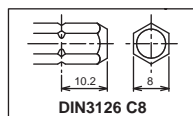

3138

Bit Holder
Klingenhalter
Porte-embouts

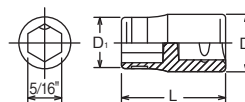

2749PS-3/8

Reversible Ratchet (Short)
Knarre kurz, verstellbar
Cliquet courte, réversible

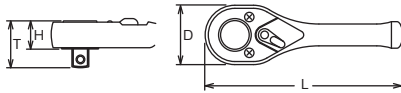

* Renewal Kits → 2749RK-3/8 → P318

	D (mm)	T (mm)	H (mm)	L (mm)	(g)	(pcs.)
2749PS-3/8	25	21.9	11.2	75	70	10

2749P-3/8

Reversible Ratchet
Knarre, verstellbar
Cliquet, réversible

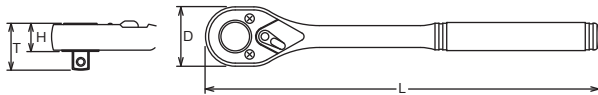

* Renewal Kits → 2749RK-3/8 → P318

	D (mm)	T (mm)	H (mm)	L (mm)	(g)	(pcs.)
2749P-3/8	25	21.9	11.2	125	101	1

2749-3/8 series have less strength compared with normal [38] ratchet due to the technical design. Make sure to use the ratchet correctly.

3749S

Reversible Ratchet (Short)
Knarre kurz, verstellbar
Cliquet courte, réversible



* Renewal Kits → 3749RK → P318

3749SB

Reversible Ratchet with quick release button
Knarre, verstellbar mit Entriegelungsknopf
Cliquet, réversible avec bouton de débrayage

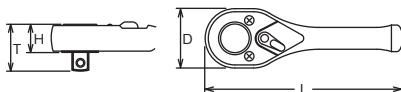

* Renewal Kits → 3749BRK → P318

	D (mm)	T (mm)	H (mm)	L (mm)	(g)	(pcs.)
3749S	34	24.8	14.1	110	183	5
3749SB	34	24.8	14.1	110	183	5

Reversible Ratchet with quick release button has less strength compared with normal ratchet due to the technical design. Make sure to use the ratchet correctly.

3753SM

Multi Purpose Ratchet, reversible
Knarre mit 2 Vierkantöffnungen, umstellbar
Cliquet réversible deux carrés femelles, réversibles

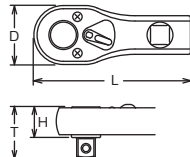

* Renewal Kits → 3753RK → P318

	D (mm)	T (mm)	H (mm)	L (mm)	(g)	(pcs.)
3753SM	30.5	26.4	15.7	81	175	5

3753SMB

Multi Purpose Ratchet, reversible, with quick release button
Knarre mit 2 Vierkantöffnungen, mit Entriegelungsknopf umstellbar
Cliquet réversible deux carrés, avec bouton de débrayage

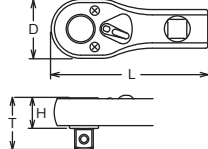

* Renewal Kits → 3753BRK → P318

	D (mm)	T (mm)	H (mm)	L (mm)	(g)	(pcs.)
3753SMB	30.5	26.4	15.7	81	175	5



[L/R Marking]



* Renewal Kits → 3752RK → P319



* Renewal Kits → 3752RK → P319

A pointer and L/R markings on the ratchet head indicate the turning direction. The reduced diameter of the head allows easier access in tight spots.

Eine L/R Markierung auf dem Knarrenkopf zeigt die gerade eingestellte Drehrichtung an. Der geringe Kopfdurchmesser erleichtert das Arbeiten auch an schwer zugänglichen Stellen.

Un marquage L/R sur la tête de cliquet indique le sens de rotation. Le diamètre de tête réduit facilite le travail dans les endroits difficilement accessibles.

	D (mm)	T (mm)	H (mm)	L (mm)	(g)	(pce.)
3752J	33	34.3	23.9	200	310	1
3752N	33	34.3	23.9	200	310	1



3752J Reversible Ratchet
Knarre, verstellbar
Cliquet, réversible



3752N Reversible Ratchet
Knarre, verstellbar
Cliquet, réversible

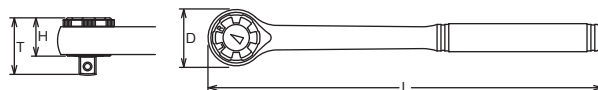

* Renewal Kits → 3753RK → P318



* Renewal Kits → 3753RK → P318



* Renewal Kits → 3753RK → P318



* Renewal Kits → 3753RK → P318



3753J Reversible Ratchet
Knarre, verstellbar
Cliquet, réversible

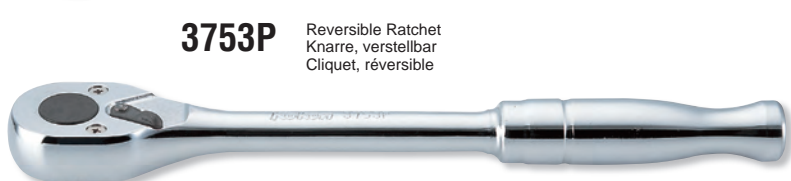

3753P Reversible Ratchet
Knarre, verstellbar
Cliquet, réversible



3753N Reversible Ratchet
Knarre, verstellbar
Cliquet, réversible



D3753J Reversible Ratchet
Knarre, verstellbar
Cliquet, réversible

	D (mm)	T (mm)	H (mm)	L (mm)	(g)	(pce.)
3753J	30.5	26.4	15.7	200	260	1
3753P	30.5	26.4	15.7	200	286	1
3753N	30.5	26.4	15.7	200	320	1
D3753J	30.5	26.4	15.7	200	260	1

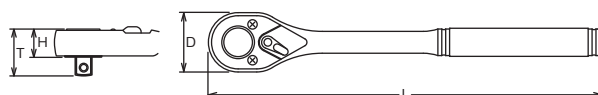

* Renewal Kits → 3753RK → P318



3753P-250 Reversible Ratchet (Long)
Verstellbare Knarre, lang ⚠
Cliquet réversible, long

	D (mm)	T (mm)	H (mm)	L (mm)	(g)	(pce.)
3753P-250	30.5	26.4	15.7	250	335	1

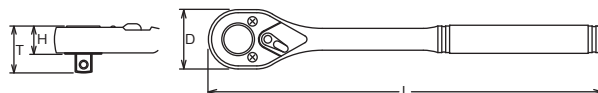

⚠ 3753P-250 have longer handle than standard, and can be loaded to excessive torque value. In the interest of your own safety always apply load evenly and progressively to avoid breakage and possible injury.

Hand Sockets Hand Steckschlüssel **3/8"** Douilles à main

Z-SERIES
HAND
TITANIUM
SCREWDRIVERS ACCESSORIES
IMPACT
SLEEVE-DRIVE
PROTECTOR
INDUSTRIAL
AUTOMOTIVE
CONSTRUCTION MOTORCYCLE
SPARE PART

3753JB Reversible Ratchet with quick release button
Knarre, verstellbar mit Entriegelungsknopf
Cliquet, réversible avec bouton de débrayage



* Renewal Kits → **3753BRK** → **P318**

3753PB Reversible Ratchet with quick release button
Knarre, verstellbar mit Entriegelungsknopf
Cliquet, réversible avec bouton de débrayage



* Renewal Kits → **3753BRK** → **P318**

3753NB Reversible Ratchet with quick release button
Knarre, verstellbar mit Entriegelungsknopf
Cliquet, réversible avec bouton de débrayage



* Renewal Kits → **3753BRK** → **P318**

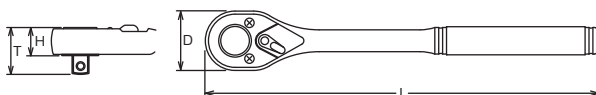

	D (mm)	T (mm)	H (mm)	L (mm)	(g)	(pce.)
3753JB	30.5	26.4	15.7	200	260	1
3753PB	30.5	26.4	15.7	200	286	1
3753NB	30.5	26.4	15.7	200	320	1

! Reversible Ratchet with quick release button has less strength compared with normal ratchet due to the technical design. Make sure to use the ratchet correctly.

Die Umschaltknarre mit Entriegelungsknopf hat aufgrund der technischen Konstruktion eine geringere Festigkeit als eine normale Ratsche. Stellen Sie sicher, dass Sie die Ratsche richtig verwenden.

Le cliquet réversible avec bouton de débrayage a une résistance moindre que le cliquet normal en raison de sa conception technique. Veuillez utiliser le cliquet correctement.

2774JS-3/8 Flexible Ratchet, reversible
Gelenk-Knarre, verstellbar
Cliquet articulé, réversible



* Renewal Kits → **2749RK-3/8** → **P318**

2774PS-3/8 Flexible Ratchet, reversible
Gelenk-Knarre, verstellbar
Cliquet articulé, réversible



* Renewal Kits → **2749RK-3/8** → **P318**

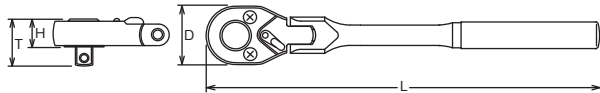

	D (mm)	T (mm)	H (mm)	L (mm)	(g)	(pce.)
2774JS-3/8	25	21.9	11.2	120	113	1
2774PS-3/8	25	21.9	11.2	120	133	1

! 2774-3/8 series have less strength compared with normal **38** ratchet due to the technical design. Make sure to use the ratchet correctly.

3774PS Flexible Ratchet, reversible
Gelenk-Knarre, verstellbar
Cliquet articulé, réversible



* Renewal Kits → **3753RK** → **P318**

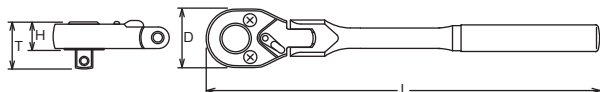

	D (mm)	T (mm)	H (mm)	L (mm)	(g)	(pce.)
3774PS	30.5	26.4	15.7	175	250	1

Hand Sockets Hand Steckschlüssel Douilles à main

Z-SERIES
HAND
TITANIUM
ACCESSORIES
SCREWDRIVERS
IMPACT
SLEEVE-DRIVE
PROTECTOR
INDUSTRIAL
AUTOMOTIVE
MOTORCYCLE
CONSTRUCTION
SPARE PART



3774J Flexible Ratchet, reversible
Gelenk-Knarre, verstellbar
Cliquet articulé, réversible

* Renewal Kits → 3753RK → P318

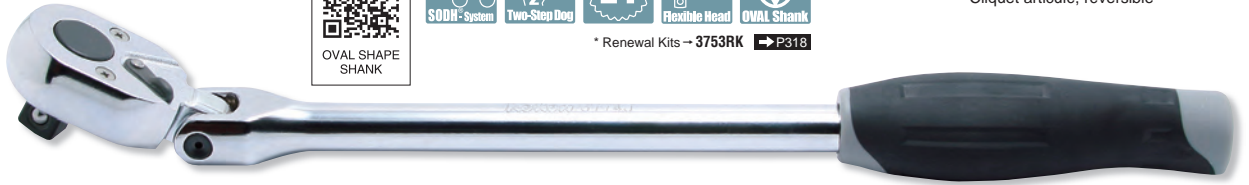

3774P Flexible Ratchet, reversible
Gelenk-Knarre, verstellbar
Cliquet articulé, réversible

* Renewal Kits → 3753RK → P318



3774N Flexible Ratchet, reversible
Gelenk-Knarre, verstellbar
Cliquet articulé, réversible

* Renewal Kits → 3753RK → P318



	D (mm)	T (mm)	H (mm)	L (mm)	(g)	(pce.)
3774J	30.5	26.4	15.7	285	367	1
3774P	30.5	26.4	15.7	265	378	1
3774N	30.5	26.4	15.7	265	378	1

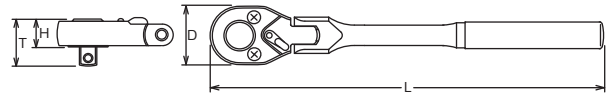

* Renewal Kits → 3753BRK → P318

3774JB Flexible Ratchet, reversible with quick release button
Gelenk-Knarre, verstellbar mit Entriegelungsknopf
Cliquet, articulée, réversible avec bouton de débrayage



	D (mm)	T (mm)	H (mm)	L (mm)	(g)	(pce.)
3774JB	30.5	26.4	15.7	285	367	1
3774PB	30.5	26.4	15.7	265	373	1
3774NB	30.5	26.4	15.7	265	378	1

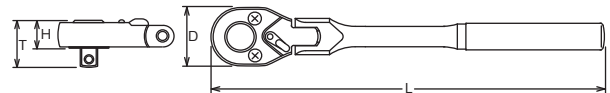

⚠ Reversible Ratchet with quick release button has less strength compared with normal ratchet due to the technical design. Make sure to use the ratchet correctly.

Die Umschaltknarre mit Entriegelungsknopf hat aufgrund der technischen Konstruktion eine geringere Festigkeit als eine normale Ratsche. Stellen Sie sicher, dass Sie die Ratsche richtig verwenden.

Le cliquet réversible avec bouton de libération rapide a une résistance moindre que le cliquet normal en raison de sa conception technique. Veuillez à utiliser le cliquet correctement.

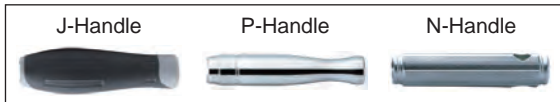

Reversible Ratchet with Quick Release Button :
Sockets and accessories are safely locked. By pushing the button the sockets or extension bars are released from the ratchet.

Umstellbare Knarre mit Entriegelungsknopf :
Steckschlüssel und Zubehörteile werden sicher und fest gehalten. Bei Drücken des Knopfes lösen sich die Teile.

Cliquet réversible avec bouton de débrayage :
Les douilles et accessoires ne peuvent plus se libérer. Une pression du pouce sur le bouton suffit pour les extraire.



* Renewal Kits → 3753RK → P318

3774JL Flex-Head Ratchet with Head Lock Button
Gelenk-Knarre, mit feststellbarem Gelenk
Cliquet à tête articulée avec bouton de blocage

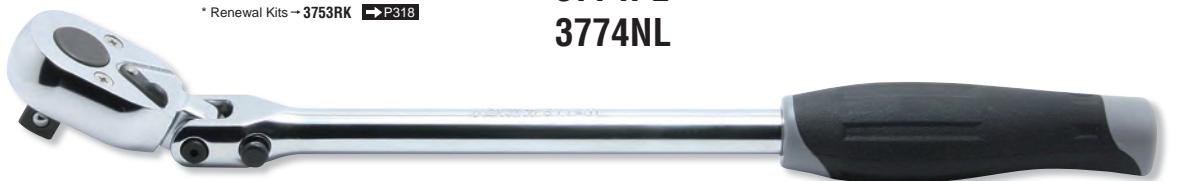

	D (mm)	T (mm)	H (mm)	L (mm)	(g)	(pce.)
3774JL	30.5	26.4	15.7	285	367	1
3774PL	30.5	26.4	15.7	265	378	1
3774NL	30.5	26.4	15.7	265	378	1

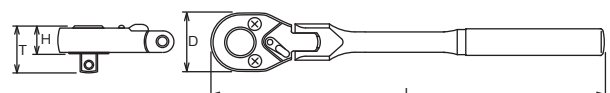

Z-SERIES
HAND
TITANIUM
SCREWDRIVERS
ACCESSORIES
IMPACT
SLEEVE-DRIVE
PROTECTOR
INDUSTRIAL
AUTOMOTIVE
MOTORCYCLE
CONSTRUCTION
SPARE PART

3774JBL Flex-Head Ratchet with Head Lock Button and Quick Release Button

Gelenk-Knarre, mit feststellbarem Gelenk und Entriegelungsknopf
Cliquet à tête articulée avec bouton de blocage et de débrayage



* Renewal Kits → 3753BRK → P318

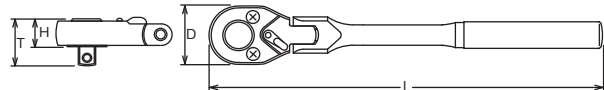

	D (mm)	T (mm)	H (mm)	L (mm)	(g)	(pce.)
3774JBL	30.5	26.4	15.7	285	367	1

Reversible Ratchet with quick release button has less strength compared with normal ratchet due to the technical design. Make sure to use the ratchet correctly.

Die Umschaltknarre mit Entriegelungsknopf hat aufgrund der technischen Konstruktion eine geringere Festigkeit als eine normale Ratsche. Stellen Sie sicher, dass Sie die Ratsche richtig verwenden.

Le cliquet réversible avec bouton de débrayage rapide a une résistance moindre que le cliquet normal en raison de sa conception technique. Veuillez utiliser le cliquet correctement.

3774P-SR Speeder Ratchet

Kurbel-Knarre
Vielebrequin à cliquet

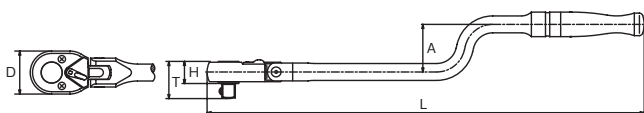

* Renewal Kits → 3753RK → P318



	D (mm)	T (mm)	H (mm)	A (mm)	L (mm)	(g)	(pce.)
3774P-SR	30.5	26.4	15.7	34	310	435	1

3776J Swivel Head Ratchet

Schwenkopf-Knarre
Cliquet à tête pivotante



* Renewal Kits → 3752RK → P319



3776P Swivel Head Ratchet

Schwenkopf-Knarre
Cliquet à tête pivotante



* Renewal Kits → 3752RK → P319



3776N Swivel Head Ratchet

Schwenkopf-Knarre
Cliquet à tête pivotante



* Renewal Kits → 3752RK → P319

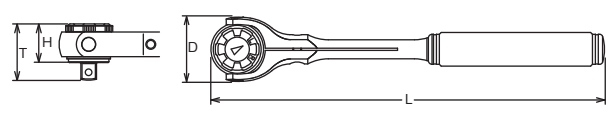

	D (mm)	T (mm)	H (mm)	L (mm)	(g)	(pce.)
3776J	44	34.3	23.9	280	510	1
3776P	44	34.3	23.9	280	560	1
3776N	44	34.3	23.9	280	565	1

45

* Renewal Kits → 3755RK → P319

	D (mm)	L (mm)	(g)	(pcs.)
3755	30.5	55	146	5

3755 Ratchet Adaptor
Aufsteckknarre
Cliquet adaptable

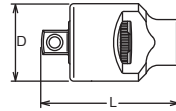

	D (mm)	L (mm)	(g)	(pcs.)
3756	30.5	25.5	47	10

3756 Quick Spinner
Rändel-Drehscheibe
Lanceur

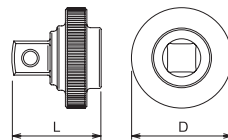

L/R Marking
45

* Renewal Kits → 3752RK → P319

	D (mm)	L (mm)	(g)	(pcs.)
3757	50	35	155	5

3757 Ratchet Wheel
Umstellbares Knarren-Handrad
Cliquet réversible à roue

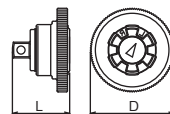

3762 Flexible Extension Bar
Biegsame Verlängerung
Rallonge flexible

	D (mm)	L (mm)	(g)	(pcs.)
3762	19.3	300	178	2

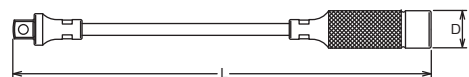

3760 Extension Bars Verlängerungen Rallonges

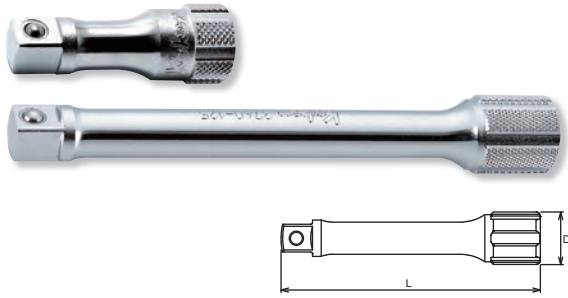

PK3760/6 Extension Set in Plastic Box Verlängerungen in Kunststoffkassette Jeu de rallonges en boîte plastique



3763 Wobble-Fix Extension Bars Winkel-Verlängerungen Rallonges angulaires

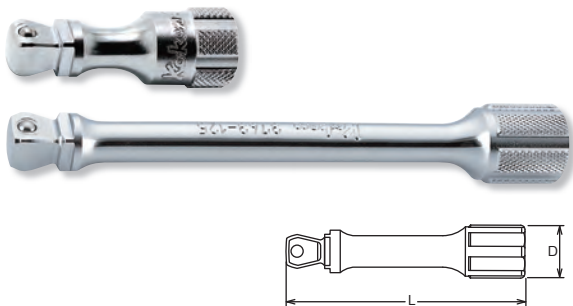

PK3763/6 Wobble-Fix Extension Bars in Plastic Box Winkel-Verlängerungen in Kunststoffkassette Jeu de rallonges angulaires en boîte plastique



	D (mm)	L (mm)	(g)	(pcs.)
3760-32	18	32	27	10
3760-50	18	50	47	10
3760-75	18	75	68	10
3760-125	18	125	106	10
3760-150	18	150	125	10
3760-250	18	250	196	5
3760-300	18	300	291	2
3760-400	18	400	365	1
3760-500	18	500	490	1
3760-600	18	600	538	1
3760-900	18	900	805	1
3760-1000	18	1000	968	1

PK3760/6 6 Pieces Set/△=670g PLASTIC TRAY

Extension Bars	
3760 Extension Bars	32, 50, 75, 125, 150, 250

Rotation and general handling of extensions with oily hands is greatly improved with the **Koken** developed 6 point knurling. Also the **Koken** 6 point knurling stops the extensions from rolling around the work area.

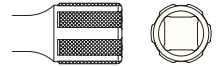

Durch die von **Koken** entwickelte 6 fache Rändelung wird die Handhabung deutlich erleichtert. Außerdem wird das Herumrollen der Verlängerungen wirksam verhindert.

La manipulation des rallonges est grandement facilitée par le profil moleté développé par **Koken**. Ce même profil empêche le roulement intempestif des rallonges sur le plan de travail.



	D (mm)	L (mm)	(g)	(pcs.)
3763-32	18	32	26	10
3763-50	18	50	42	10
3763-75	18	75	57	10
3763-125	18	125	80	10
3763-150	18	150	98	10
3763-250	18	250	144	5
3763-300	18	300	170	2

PK3763/6 6 Pieces Set/△=560g PLASTIC TRAY

Extension Bars	
3763 Wobble-Fix Extension Bars	32, 50, 75, 125, 150, 250

Wobble-Fix Extension Bar

- Two way usage
a) In a fixed position, as a normal extension bar
b) In a half-fixed position, as a flexible extension bar providing a 15° angle operation

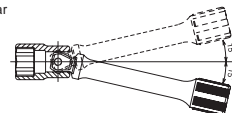
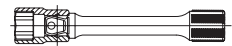

Winkel-Verlängerungen

Winkelverlängerungen lassen sich in zwei Einstellungen verwenden

- a) voll eingesteckt und starr,
b) halb eingesteckt, mit einem Arbeitswinkel von 15°.

Rallonges angulaires

Deux utilisations possibles

- a) comme rallonge normale, dans une position fixe
b) comme une rallonge angulaire avec une possibilité d'inclinaison jusqu'à 15°

⚠ The Wobble-Fix Extension Bar has less strength than normal extension bar due to its specific design with a reduced square drive. Make sure to use it correctly.

Die Wobble-Fix Verlängerungen haben aufgrund ihrer speziellen Konstruktion mit einem reduzierten Vierkanttrieb eine geringere Festigkeit als eine normale Verlängerung. Achten Sie darauf, sie richtig zu verwenden.

La barre d'extension wobble-fix est moins résistante qu'une barre d'extension normale en raison de sa conception spécifique avec un carré d'entraînement réduit. Veuillez l'utiliser correctement.



* Renewal Kits → 3768RK → P321



OVAL SHAPE SHANK



RENEWAL KIT FOR HINGE HANDLE

3768J-250

Hinge Handle
Gelenkgriff
Poignée articulée



* Renewal Kits → 3768RK → P321

3768P-250

Hinge Handle
Gelenkgriff
Poignée articulée



* Renewal Kits → 3768RK → P321

3768P-380

Hinge Handle
Gelenkgriff
Poignée articulée



	D (mm)	L (mm)	(g)	(pcs.)
3768J-250	20.5	250	248	2
3768P-250	20.5	250	275	5
3768P-380	20.5	380	435	2

⚠ 3768P-380 has longer handle than standard, and can be loaded to excessive torque value. In the interest of your own safety always apply load evenly and progressively to avoid breakage and possible injury.

Der Gelenkgriff 3768-380 ist länger als die Standardversion. Aus Gründen Ihrer Sicherheit, sollten dies Werkzeug nie ruckartig sondern nach und nach belastet werden, um Bruch und damit verbundene, mögliche Verletzungen zu vermeiden.

Dû au fait que les manches des 3768-380 sont plus longues que le standard, il y a risque d'une surcharge excessive lors du serrage. Pour éviter casse et blessure, veuillez serrer d'une façon régulière et progressive.

	H (mm)	L (mm)	(g)	(pcs.)
3769N				
160	50	160	110	2
230	120	230	135	2



WOBBLE-FIX EXTENSION BAR



	H (mm)	L (mm)	(g)	(pcs.)
3769NWF				
160	50	160	110	2
230	120	230	135	2

⚠ Plastic or rubber handles are not intended to act as insulation.

Plastik-oder Gummigriffe stellen keinen Isolierschutz dar.

Les poignées en plastique ou en caoutchouc ne garantissent aucune isolation électrique.

	L (mm)	(g)	(pcs.)
3769H	170	210	2

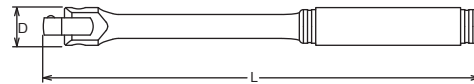

3769N-160 / -230

Spin Type Handle
Drehgriff
Poignée emmanchée

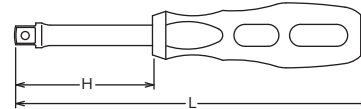

3769NWF-160 / -230

Spin Type Handle Wobble-Fix
Drehgriff, Wobble-Fix
Poignée emmanchée, angulaire

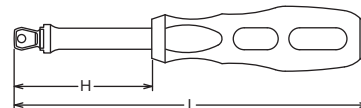

3769H

Folding Socket Driver
Klapp-Drehgriff
Poignée tournevis articulée

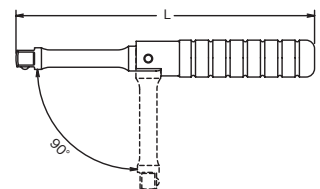

Hand Sockets Hand Steckschlüssel Douilles à main

3/8"

Z-SERIES
HAND
TITANIUM
SCREWDRIVERS ACCESSORIES
IMPACT
SLEEVE-DRIVE
PROTECTOR
INDUSTRIAL
AUTOMOTIVE
MOTORCYCLE
CONSTRUCTION
SPARE PART

3770 Universal Joint
Gelenk-Einsatz
Cardan universel

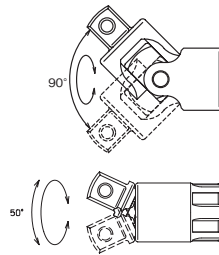

3771 Universal Joint
Gelenk-Einsatz
Joint articulé



	L (mm)	(g)	(pcs.)
3770	50	66	10
3771	43	46	10

3780 Speed Handle
Winde
Vilebrequin



	L (mm)	(g)	(pcs.)
3780	400	432	1

3785 T-Handle
T-Griff
Poignée coulissante

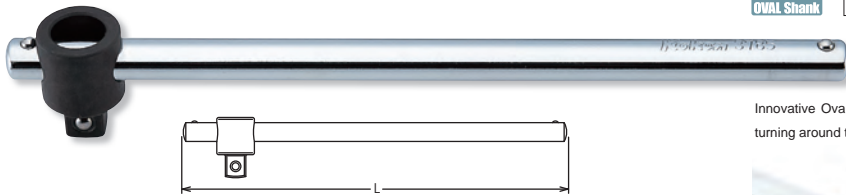

Innovative Oval shaped bar provides higher durability and stops the sliding square part turning around the bar.



3322A Adaptor
Verbindungsstück
Augmentateur

Warranty 86Nm
Garantie 86Nm
Garantie 86Nm

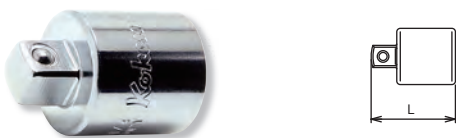

3344A Adaptor
Verbindungsstück
Augmentateur



	L (mm)	(g)	(pcs.)
3785	200	157	5

	(sq.)	(sq.)	L (mm)	(g)	(pcs.)
3322A	3/8"	1/4"	24	18	10
3344A	3/8"	1/2"	30	35	10

⚠ Adapting down from bigger square drive to smaller square drive may lead to excessive torque and possibly cause breakage.

Reduzierstücke sind mit Vernunft einzusetzen. Es besteht Bruchgefahr. Überschreiten Sie niemals die Sicherheitsgrenzen.

Les réducteurs doivent être utilisés avec modération. Ne dépassez jamais la limites de sécurité.

PK2346/6 Adaptor Set in Plastic Box
Adaptor Satz in Kunststoffkassette
Jeu de adaptateur en boîte plastique



2233A	(11/4") X 3/8"		
3322A	(3/8") X 1/4"	Warranty/Garantia	86Nm
3344A	(3/8") X 1/2"		
4433A	(11/2") X 3/8"	Warranty/Garantia	290Nm
4466A	(11/2") X 3/4"		
6644A	(3/4") X 1/2"	Warranty/Garantia	668Nm

PK2346/6		6 Pieces Set / 460g	
PLASTIC TRAY			
Adaptors			
1/4" □ → 3/8" □	2233A	3/8" □ → 1/4" □	3322A
3/8" □ → 1/2" □	3344A	1/2" □ → 3/8" □	4433A-35
1/2" □ → 3/4" □	4466A	3/4" □ → 1/2" □	6644A

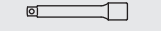
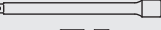
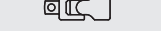
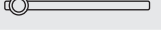
ESH3001 17 Pieces Set/△=2,200g	
METAL CASE:W415xH120xT50mm	
Sockets	Accessories
3410M Surface Drive Sockets 8, 9, 10, 11, 12, 13, 14, 15, 16, 17, 18, 19	 3753J  3760-125  3760-250  3770  3785







ESH3001 Socket Set
Steckschlüssel Satz
Jeu de clés à douille

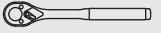

ETH3001 22 Pieces Set/△=1,820g	
METAL CASE:W392xH90xT50mm	
Sockets	Accessory
3425 TORX® Sockets E4, E5, E6, E7, E8 4425 TORX® Sockets E10, E11, E12, E14, E16, E18 3025.50 TORX® Bit Sockets T10, T15, T20, T25, T27 4025.60 TORX® Bit Sockets T30, T40, T45, T50, T55	 4433A-35

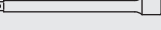
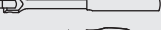

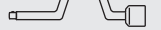
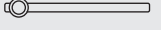

ETH3001 Socket Set
Steckschlüssel Satz
Jeu de clés à douille



3201AMW 42 Pieces Set/△=4,700g	
METAL CASE:W445xH190xT50mm	
Sockets	Accessories
3405M 12-pt. Sockets 9, 10, 11, 12, 13, 14, 15, 16, 17, 18, 19, 20, 21, 22 3405A 12-pt. Sockets 5/16, 3/8, 7/16, 1/2, 9/16, 5/8, 11/16, 3/4, 25/32, 13/16, 7/8 3405W 12-pt. Sockets 1/8, 3/16, 1/4, 5/16, 3/8, 7/16, 1/2	 3753N  3760-75  3760-125  3760-250  3768N-250  3769N-160  3770  3780  3785  3344A

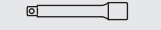

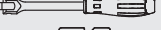
3201AMW Socket Set
Steckschlüssel Satz
Jeu de clés à douille



3206AM 27 Pieces Set/△=3,500g	
METAL CASE:W445xH190xT50mm	
Sockets	Accessories
3405M 12-pt. Sockets 7, 8, 10, 11, 12, 13, 14, 15, 16, 17, 19, 22 3405A 12-pt. Sockets 3/8, 7/16, 1/2, 9/16, 5/8, 11/16, 3/4, 13/16, 7/8 3300C Spark Plug Socket 20.8	 3753J  3760-125  3760-250  3768J-250  3770



3206AM Socket Set
Steckschlüssel Satz
Jeu de clés à douille

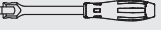
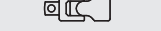
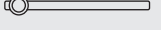

3210M-00 22 Pieces Set/△=2,900g 3210M-05 22 Pieces Set/△=2,900g 3210M-10 22 Pieces Set/△=2,900g	
METAL CASE:W360xH145xT50mm	
Sockets	Accessories
(3210M-00) 3400M 6-pt. Sockets 6, 7, 8, 9, 10, 11, 12, 13, 14, 15, 16, 17, 18, 19, 21, 22 (3210M-05) 3405M 12-pt. Sockets 6, 7, 8, 9, 10, 11, 12, 13, 14, 15, 16, 17, 18, 19, 21, 22 (3210M-10) 3410M Surface Drive Sockets 6, 7, 8, 9, 10, 11, 12, 13, 14, 15, 16, 17, 18, 19, 21, 22	 3753J  3760-125  3760-250  3768J-250  3770  3785

3210M-00 / 3210A-00 Socket Set
Steckschlüssel Satz
Jeu de clés à douille
3210M-05 / 3210A-05
3210M-10

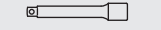
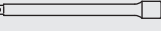
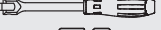

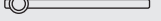
3210A-00 18 Pieces Set/△=2,760g 3210A-05 18 Pieces Set/△=2,760g	
METAL CASE:W360xH145xT50mm	
Sockets	Accessories
(3210A-00) 3400A 6-pt. Sockets 1/4, 5/16, 11/32, 3/8, 7/16, 1/2, 9/16, 5/8, 11/16, 3/4, 13/16, 7/8 (3210A-05) 3405A 12-pt. Sockets 1/4, 5/16, 11/32, 3/8, 7/16, 1/2, 9/16, 5/8, 11/16, 3/4, 13/16, 7/8	 3753J  3760-125  3760-250  3768J-250  3770  3785

Z-SERIES
HAND
TITANIUM
ACCESSORIES
SCREWDRIVERS
IMPACT
SLEEVE-DRIVE
PROTECTOR
INDUSTRIAL
AUTOMOTIVE
MOTORCYCLE
CONSTRUCTION
SPARE PART

3216 Spark Plug Sockets Set
Zündkerzen-Schlüssel Satz
Jeu de douilles pour bougies



3216 4 Pieces Set/△=730g	
PLASTIC BAG	
Sockets	Accessories
3300C Spark Plug Sockets 16, 20.8	3760-125 3774JL

3217M-00 Socket Set
Steckschlüssel Satz
Jeu de clés à douille
3217M-05
3217M-10



3217M-00	14 Pieces Set/△=850g
3217M-05	14 Pieces Set/△=850g
3217M-10	14 Pieces Set/△=850g
METAL CASE:W163xH52xT33mm	
Sockets	
(3217M-00) 3400M 6-pt. Sockets 9, 10, 11, 12, 13, 14, 15, 16, 17, 18, 19, 20, 21, 22	
(3217M-05) 3405M 12-pt. Sockets 9, 10, 11, 12, 13, 14, 15, 16, 17, 18, 19, 20, 21, 22	
(3217M-10) 3410M Surface Drive Sockets 9, 10, 11, 12, 13, 14, 15, 16, 17, 18, 19, 20, 21, 22	

S3240M-00 / S3240A-00 Display Stands
Ausstellungsständer
S3240M-05 / S3240A-05 Présentoirs



S3240M-00	3400M 177 Pieces Set/△=10,300g	
S3240M-05	3405M 177 Pieces Set/△=10,300g	
DISPLAY STAND:W510xH150xT230mm		
Sockets		
6mm:12pcs	12mm:12pcs	18mm:8pcs
7mm:12pcs	13mm:11pcs	19mm:8pcs
8mm:12pcs	14mm:11pcs	20mm:7pcs
9mm:12pcs	15mm:10pcs	21mm:7pcs
10mm:12pcs	16mm: 9pcs	22mm:7pcs
11mm:12pcs	17mm: 9pcs	23mm:6pcs

S3240A-00	3400A 126 Pieces Set/△=8,500g	
S3240A-05	3405A 126 Pieces Set/△=8,500g	
DISPLAY STAND:W510xH150xT230mm		
Sockets		
1/4" :12pcs	9/16":10pcs	25/32":7pcs
5/16":12pcs	19/32":10pcs	13/16":7pcs
3/8" :12pcs	5/8" : 9pcs	7/8" :7pcs
7/16":12pcs	11/16": 9pcs	
1/2" :11pcs	3/4" : 8pcs	





3250M-00 Socket Set
Steckschlüssel Satz
Jeu de clés à douille
3250M-05



3250M-00	17 Pieces Set/△=2,200g	
3250M-05	17 Pieces Set/△=2,200g	
METAL CASE:W415xH120xT50mm		
Sockets	Accessories	
3400M 6-pt. Sockets 7, 8, 10, 11, 12, 13, 14, 15, 16, 17, 18, 19	3753J 3760-125	
3405M 12-pt. Sockets 7, 8, 10, 11, 12, 13, 14, 15, 16, 17, 18, 19	3760-250 3770 3785	

3251 8 Pieces Set/△=675g

METAL CASE:W160xH100xT28mm

Sockets	Accessories
 3025.50 TORX® Bit Sockets T25H, T30H, T40H, T45H, T50H	 2774PS-3/8
	 3763-50
	 3756







3251

Bit Socket Set
Schraubendreher-Steckschlüssel Satz
Jeu de douilles de vissage



3252M 15 Pieces Set/△=1,530g

METAL CASE:W310xH90xT48mm

Sockets	Accessories
 3400M 6-pt. Sockets 5.5, 7, 8, 10, 11, 12	 3753P
 3405M 12-pt. Sockets 13, 14, 17, 19, 22	 3760-75
	 3760-125
	 3770









3252M

Socket Set
Steckschlüssel Satz
Jeu de clés à douille



3275 24 Pieces Set/△=3,150g

METAL CASE:W400xH147xT50mm

Sockets	Accessories
 3400M 6-pt. Sockets 6, 7, 8, 9, 10, 11, 12	 3753J
 3405M 12-pt. Sockets 13, 14, 15, 16, 17, 18, 19, 21, 22	 3760-125
 3300C Spark Plug Sockets 16, 20.8	 3768J-250
	 3770
	 3756







3275

Socket Set
Steckschlüssel Satz
Jeu de clés à douille



3277 29 Pieces Set/△=3,240g

METAL CASE:W370xH150xT50mm

Sockets	Accessories
 3400M 6-pt. Sockets 8, 9, 10, 11, 12	 3753J
 3405M 12-pt. Sockets 13, 14, 15, 16, 17, 18, 19, 21	 3760-125
 3300M 6-pt. Deep Sockets 8, 9, 10, 11, 12	 3768J-250
 3305M 12-pt. Deep Sockets 13, 14, 15, 16, 17, 18, 19, 21	







3277

Socket Set
Steckschlüssel Satz
Jeu de clés à douille



3278 20 Pieces Set/△=3,370g

METAL CASE:W310xH150xT50mm

Sockets	Accessories
 3000 Bit Sockets 2, 3	 3753J
 3010M.62 Hex Bit Sockets 5, 6, 7, 8, 10	 3763-125
 3020.50 XZN Bit Sockets M4, M5, M6, M8	
 3025.50 TORX® Bit Sockets T10, T15, T20, T25, T27, T30, T40	

3278

Bit Socket Set
Schraubendreher-Steckschlüssel Satz
Jeu de douilles de vissage



Z-SERIES
HAND
TITANIUM
SCREWDRIVERS ACCESSORIES
IMPACT
SLEEVE-DRIVE
PROTECTOR
INDUSTRIAL
AUTOMOTIVE
CONSTRUCTION MOTORCYCLE
SPARE PART

4401M 6-point Sockets 6-kant Steckschlüssel Douilles 6-pans



HANDY-ENDY®

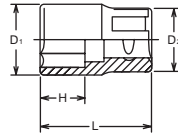

4401M 4406M (mm)	D ₁ (mm)	D ₂ (mm)	H (mm)	L (mm)	(g)	(pcs.)
8	13.2	22	8	36	44	10
9	13.8	22	8.5	37	44	10
10	15.3	22	9	37	45	10
11	16.5	22	9.5	37	46	10
12	17.8	22	10	37	47	10
13	19	22	10.5	37	53	10
14	20.3	22	11	37	56	10
15	21.5	22	11.5	37	52	10
16	22.8	22	12	37	62	10
17	24	22	12.5	37	69	10
18	25	23	13	37	74	10
19	26.5	24.5	14	38	89	10
20	27.8	26	15	38	92	10
21	29	27	15.5	38	102	10
22	30	28	16	40	113	10
23	31.5	29	16.5	40	128	10
24	32.8	30	17	42	140	5
25	34	31	18	42	164	5
26	35	32	19	42	165	5
27	36.5	33	19.5	43	196	5
28	37.8	34	20	43	198	5
29	39	35	20.5	43	190	5
30	40	36	22	46	222	5
31	41.5	37	22.5	46	257	5
32	42.8	38	23	46	250	5

4406M 12-point Sockets 12-kant Steckschlüssel Douilles 12-pans



HANDY-ENDY®

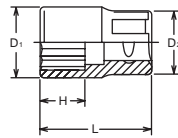

4400M 6-point Sockets 6-kant Steckschlüssel Douilles 6-pans

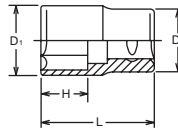

4400M 4405M (mm)	D ₁ (mm)	D ₂ (mm)	H (mm)	L (mm)	(g)	(pcs.)
33	44.2	39	24	47	275	5
34	45.2	40	24	47	315	5
35	46.2	40	24	47	317	5
36	47.2	41	24	47	336	5
37	48.3	42	24	47	360	5
38	49.2	43	24	47	380	5
41	53.1	45	29	57	471	5
46	59.1	48	32	60	567	2

4405M 12-point Sockets 12-kant Steckschlüssel Douilles 12-pans

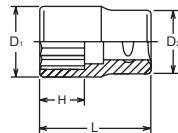

RS4401M/10 Socket Set on Rail Steckschlüsselsatz auf Schiene Jeu de douilles sur rail



RS4401M/10	10 Pieces Set/Rail 300mm	(g)
10, 11, 12, 13, 14, 15, 16, 17, 18, 19		720

RS4406M/10 Socket Set on Rail Steckschlüsselsatz auf Schiene Jeu de douilles sur rail



RS4406M/10	10 Pieces Set/Rail 300mm	(g)
10, 11, 12, 13, 14, 15, 16, 17, 18, 19		720

4400A 4405A (inch)	D ₁ (mm)	D ₂ (mm)	H (mm)	L (mm)	(g)	(pcs.)
1/4	10.7	21	6	36	41	10
5/16	13.2	21	8	36	44	10
3/8	14.6	21	9	37	45	10
7/16	16.5	21	9.5	37	46	10
1/2	19	22	10.5	37	53	10
9/16	20.3	22	11	37	56	10
19/32	21.5	22	11.5	37	52	10
5/8	22.8	22	12	37	62	10
21/32	24	23	12.5	37	69	10
11/16	25	24	13	37	74	10
3/4	26.5	25	14	38	89	10
25/32	27.8	26	15	38	92	10
13/16	29	27	15.5	38	102	10
7/8	30	28	16	40	113	10
15/16	32.8	30	17	42	140	5
31/32	34	31	18	42	165	5
1	35	32	19	42	165	5
1. 1/16	36.5	33	19.5	43	180	5
1. 1/8	39	35	20.5	43	210	5
1. 3/16	40	36	22	46	222	5
1. 1/4	42.8	38	23	46	250	5
1. 5/16	44.2	39	24	47	275	5
1. 3/8	46.2	40	24	47	317	5
1. 7/16	47.2	41	24	47	336	5
1. 1/2	49.2	43	24	47	380	5

Hand Sockets
Both, 6-pt. and 12-pt. openings, are equipped with Flat Drive Openings, transferring the turning power from the corners on the flanks of nuts and bolts.

Sowohl 6-kant als auch 12-kant Steckschlüssel bieten alle Vorteile der "Flat Drive" Öffnung, die die Greifzonen auf die Flächen von Schrauben und Muttern versetzt.

Aussi bien les douilles 6-pans que 12-pans présentent tous les avantages liés au profil FLATDRIVE qui applique la force de serrage aux faces de la vis ou de l'écrou.

4400A 6-point Sockets 6-kant Steckschlüssel Douilles 6-pans

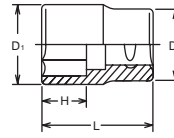

4405A 12-point Sockets 12-kant Steckschlüssel Douilles 12-pans

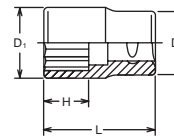

RS4400A/10	10 Pieces Set/Rail 300mm	(g)
3/8, 7/16, 1/2, 9/16, 5/8, 11/16, 3/4, 13/16, 7/8, 15/16		809

RS4405A/10	10 Pieces Set/Rail 300mm	(g)
3/8, 7/16, 1/2, 9/16, 5/8, 11/16, 3/4, 13/16, 7/8, 15/16		809

RS4400A/10 Socket Set on Rail Steckschlüsselsatz auf Schiene Jeu de douilles sur rail



	6-Point	12-Point	Surface Drive	Nut Grip®	TORX® (E)	TORXPLUS® (EPL)	Tamper-Resistant TORXPLUS® (EPRL)	Double Square	LHSTIX® (LH-S)
1/4"	No. 2400M/A No. 2300M/A No. 2400W-BA No. 2300W-BA No. 2300X series	No. 2405M/A No. 2305M/A No. AS2405A No. AS2305A series	No. 2410M No. 3310M series	No. 2450MS/AS No. 2350M No. 2350X series	No. 2425 No. 2325 series	—	—	No. 2415M/A series	—
3/8"	No. 3400M/A No. 3300M/A No. 3400W No. 3300W No. 3300X/XA series	No. 3405M/A No. 3305M/A No. 3405W No. 3305W No. 3305X/XA series	No. 3410M No. 3310M series	No. 3450M/A No. 3450MH No. 3350M No. 3350X series	No. 3425 No. 3325 series	—	—	No. 3415M/A series	No. 3400LH series
1/2"	No. 4400M/A No. 4300M/A No. 4400W series	No. 4405M/A No. 4305M/A No. 4405W series	No. 4410M No. 4310M series	No. 4450M series	No. 4425 No. 4325 series	No. 4425-EPL series	No. 4425-EPRL series	—	No. 4400LH series

4410M

Surface Drive Sockets
Surface Drive Steckschlüssel
Douilles, Surface Drive

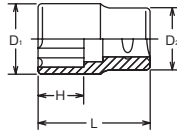

RS4410M/10

Socket Set on Rail
Steckschlüsselsatz auf Schiene
Jeu de douilles sur rail



SURFACE DRIVE

Surface drive sockets are designed to retain contact with the flat sides of the nut in order to transmit high torque and reduce nut wear. These sockets are ideal for using on polished nuts, aluminum nuts and nuts with worn out points.

Das Profil unserer Surface-Drive Steckschlüssel greift die Schraube an deren Flächen. Dies sichert eine höhere Kraftübertragung und verhindert ein Durchrutschen des Steckschlüssels. Diese Steckschlüssel eignen sich besonders für polierte Schrauben, Aluminium Schrauben und Schrauben bei denen die Ecken bereits abgerundet sind.

Notre profil Surface Drive assure le contact entre la douille et les plats de l'écrou. Ceci réduit l'usure et permet la transmission d'un couple plus élevé. C'est une solution idéale pour les écrous polies, celles en aluminium ou arrondies.

4410M (mm)	D ₁ (mm)	D ₂ (mm)	H (mm)	L (mm)	(g)	(pcs.)
8	13.2	21	8	36	44	10
9	13.8	21	8.5	37	44	10
10	15.3	21	9	37	45	10
11	16.5	21	9.5	37	46	10
12	17.8	21	10	37	47	10
13	19	22	10.5	37	53	10
14	20.3	22	11	37	56	10
15	21.5	22	11.5	37	52	10
16	22.8	22	12	37	62	10
17	24	23	12.5	37	69	10
18	25	24	13	37	74	10
19	26.5	25	14	38	89	10
20	27.8	26	15	38	92	10
21	29	27	15.5	38	102	10
22	30	28	16	40	113	10
23	31.5	29	16.5	40	128	10
24	32.8	30	17	42	140	5
25	34	31	18	42	164	5
26	35	32	19	42	165	5
27	36.5	33	19.5	43	196	5
28	37.8	34	20	43	198	5
29	39	35	20.5	43	190	5
30	40	36	22	46	222	5
31	41.5	37	22.5	46	257	5
32	42.8	38	23	46	250	5
34	45.2	40	24	47	314	5

RS4410M/10	10 Pieces Set/Rail 300mm	(g)
10, 11, 12, 13, 14, 15, 17, 19, 21, 22		717

4400W

6-point Whitworth Sockets
6-kant Steckschlüssel, Whitworth
Douilles à 6-pans Whitworth

4405W

12-point Whitworth Sockets
12-kant Steckschlüssel, Whitworth
Douilles à 12-pans Whitworth

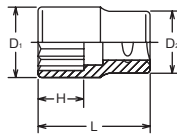

RS4400W/8

Socket Set on Rail
Steckschlüsselsatz auf Schiene
Jeu de douilles sur rail



4400W / 4405W (W)	D ₁ (mm)	D ₂ (mm)	H (mm)	L (mm)	(g)	(pcs.)
3/16	16.5	21	9.5	37	46	10
1/4	19	22	10.5	37	54	10
5/16	21.5	22	11.5	37	54	10
3/8	25	24	13	37	73	10
7/16	29	27	15.5	38	87	10
1/2	31.5	29	16.5	40	133	10
9/16	35	32	19	42	165	5
5/8	37.8	34	20	43	191	5
11/16	40	36	22	46	222	5
3/4	44.2	39	24	47	280	5

RS4400W/8	8 Pieces Set/Rail 250mm	(g)
3/16, 1/4, 5/16, 3/8, 7/16, 1/2, 9/16, 5/8		860

RS4405W/8	8 Pieces Set/Rail 250mm	(g)
3/16, 1/4, 5/16, 3/8, 7/16, 1/2, 9/16, 5/8		860

BS W



BS · W	BS	3/16BS	1/4BS	5/16BS	3/8BS	7/16BS	1/2BS	9/16BS	5/8BS	11/16BS	3/4BS	7/8BS
	W	1/8W	3/16W	1/4W	5/16W	3/8W	7/16W	1/2W	9/16W	5/8W	11/16W	3/4W
S	(ref. mm)	8.64	11.30	13.34	15.24	18.03	20.83	23.37	25.65	27.94	30.48	33.35

4425-N

TORX® Sockets
TORX® Steckschlüssel
Douilles TORX®

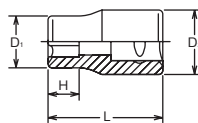

RS4425/6-N

Socket Set on Rail
Steckschlüsselsatz auf Schiene
Jeu de douilles sur rail



4425 (E)	D ₁ (mm)	D ₂ (mm)	H (mm)	L (mm)	(g)	(pcs.)
E10N	13.2	21	8.2	36	47	10
E12N	14.6	21	9.3	37	48	10
E14N	16.5	21	10.6	37	50	10
E16N	19	22	11.8	37	60	10
E18N	20.3	22	13	37	60	10
E20N	22.8	22	14.4	37	65	10

TORX Socket for Nut and low profile bolt
TORX-Steckschlüssel für Schrauben mit Flachprofil
Douille TORX pour écrou et boulon à profil bas

Shallow Chamfer on Socket Opening

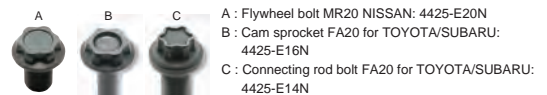

A : Flywheel bolt MR20 NISSAN: 4425-E20N
B : Cam sprocket FA20 for TOYOTA/SUBARU: 4425-E16N
C : Connecting rod bolt FA20 for TOYOTA/SUBARU: 4425-E14N

RS4425/6-N	6 Pieces Set/Rail 200mm	(g)
E10N, E12N, E14N, E16N, E18N, E20N		370

4425 (E)	D ₁ (mm)	D ₂ (mm)	H (mm)	L (mm)	(g)	(pcs.)
E 8	10.7	21	7	36	41	10
E10	13.2	21	8.2	36	44	10
E11	13.8	21	8.7	37	45	10
E12	14.6	21	9.3	37	47	10
E14	16.5	21	10.6	37	48	10
E16	19	22	11.8	37	57	10
E18	20.3	22	13	37	57	10
E20	22.8	22	14.4	37	63	10
E22	25	24	15.5	37	78	10
E24	26.5	25	17	40	95	5

RS4425/7	7 Pieces Set/Rail 200mm	(g)
E10, E12, E14, E16, E18, E20, E24		428

4425 TORX® Sockets TORX® Steckschlüssel Douilles TORX®

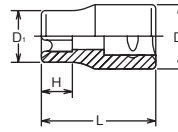

RS4425/7 Socket Set on Rail Steckschlüsselsatz auf Schiene Jeu de douilles sur rail



TORX® (E)

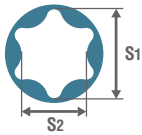

E	E4	E5	E6	E7	E8	E10	E11	E12	E14	E16	E18	E20	E22	E24	E26	E28	E30	E32
S ₁ (ref. mm)	3.7	4.6	5.6	6.1	7.4	9.3	9.9	11.0	12.8	14.6	16.5	18.3	20.1	22.0	23.7	25.5	27.3	29.0
S ₂ (ref. mm)	2.7	3.3	4.0	4.3	5.3	6.8	7.1	7.9	9.2	10.5	11.9	13.2	14.8	15.7	17.5	18.3	20.0	21.3

4425 (EPL)	D ₁ (mm)	D ₂ (mm)	H (mm)	L (mm)	(g)	(pcs.)
10EPL	13.2	21	6.2	36	45	10
12EPL	14.6	21	7.2	37	47	10
14EPL	16.5	21	8.1	37	49	10
16EPL	19	22	9.2	37	60	10
18EPL	20.3	22	10.2	37	60	10
20EPL	22.9	22	11.2	37	65	10

RS4425/6-EPL	6 Pieces Set/Rail 200mm	(g)
10EPL, 12EPL, 14EPL, 16EPL, 18EPL, 20EPL		390

4425 (EPL) TORXplus® Sockets TORXPLUS® Steckschlüssel Douilles TORXPLUS®

TORXplus®

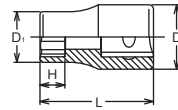

RS4425/6-EPL Socket Set on Rail Steckschlüsselsatz auf Schiene Jeu de douilles sur rail



TORXplus® (EP/EPL)

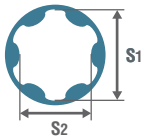

EP/EPL	8EP	10EP	12EP	14EP	16EP	18EP	20EP	22EP	24EP	26EP	28EP	30EP	32EP
S ₁ (ref. mm)	7.4	9.3	11.0	12.8	14.6	16.5	18.3	20.1	22.0	23.7	25.5	27.3	29.0
S ₂ (ref. mm)	5.7	7.1	8.5	9.8	11.2	12.7	14.0	15.4	16.8	18.2	19.6	20.9	22.3

4425 (EPRL)	D ₁ (mm)	D ₂ (mm)	H (mm)	L (mm)	(g)	(pcs.)
10EPRL	13.2	21	6.2	36	45	10
12EPRL	14.6	21	7.2	37	47	10
14EPRL	16.5	21	8.1	37	49	10
20EPRL	22.9	22	11.2	37	65	10

4425 (EPRL) Tamper-Resistant TORXPLUS® Sockets Tamper-Resistant TORXPLUS® Steckschlüssel Douilles Tamper-Resistant TORXPLUS®

TORXplus®

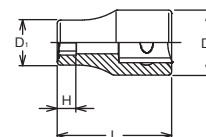

TORX is a registered trademark of CAMCAR Innovations.
TORX ist ein registriertes Markenzeichen der Firma CAMCAR Innovations.
TORX est une marque déposée de CAMCAR Innovations.

TORXplus is a registered trademark of CAMCAR Innovations.
TORXplus ist ein registriertes Markenzeichen der Firma CAMCAR Innovations.
TORXplus est une marque déposée de CAMCAR Innovations.

Hand Sockets Hand Steckschlüssel Douilles à main

1/2"

Z-SERIES
HAND
TITANIUM
SCREWDRIVERS
ACCESSORIES
IMPACT
SLEEVE-DRIVE
PROTECTOR
INDUSTRIAL
AUTOMOTIVE
MOTORCYCLE
CONSTRUCTION
SPARE PART

4400LH

 LHSTIX® Sockets
Steckschlüssel mit LHSTIX® Profil
Douilles au profil LHSTIX®

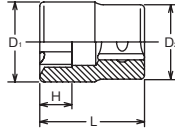

4400LH (LH-S)	D ₁ (mm)	D ₂ (mm)	H (mm)	L (mm)	(g)	(pcs.)
6S	13.2	21	5.6	36	44	10
8S	16.5	21	6.8	37	46	10
10S	19	22	8	37	53	10
12S	22.8	22	9.2	37	62	10
14S	25	24	10.4	37	74	10
16S	29	27	11.6	38	102	10

RS4400LH/6

  Socket Set on Rail
Steckschlüsselsatz auf Schiene
Jeu de douilles sur rail



RS4400LH/6	6 Pieces Set/Rail 200mm	(g)
6S, 8S, 10S, 12S, 14S, 16S		430

LHSTIX®

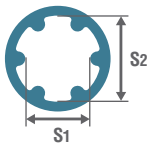

	LH-S	LH-5S	LH-6S	LH-8S	LH-10S	LH-12S	LH-14S	LH-16S
S ₁	(ref. mm)	5.6	6.8	9.0	11.3	13.6	15.8	18.1
S ₂	(ref. mm)	7.5	9.0	12.0	15.0	18.0	21.0	24.0

4450M

 Nut Grip Sockets **Nut Grip®**
Steckschlüssel mit 2-facher Kugelhalterung
Douilles à billes de retenue

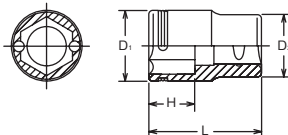

4450M (mm)	D ₁ (mm)	D ₂ (mm)	H (mm)	L (mm)	(g)	(pcs.)
10	15.3	21	6	36	44	10
11	16.5	21	6.5	36	46	10
12	17.8	21	7	36	46	10
13	19	22	8	36	52	10
14	20.3	22	8.5	36	54	10
15	21.5	22	9	36	52	10
16	22.8	22	9	36	60	10
17	24	23	9.5	36	68	10
18	25	24	10.5	36	77	10
19	26.5	25	11.5	36	85	10
21	29	27	12	37	110	10
22	30	28	12.5	37	105	10
24	32.8	30	14.5	39	130	5
27	36.5	33	16.5	40	139	5

NUT GRIP®

Twin balls at the 6-point opening hold bolt/nut tightly for safe and reliable work.

Die zwei Kugeln in der 6-kant Öffnung unserer NUT GRIP Steckschlüssel halten die Schraube sicher im Steckschlüssel. Dies erlaubt ein Arbeiten auch an schwer zugänglichen Stellen.

Les 2 billes dans l'ouverture du 6-pans de la douille retiennent l'écrou de manière sûre et efficace.

RS4450M/10

  Socket Set on Rail
Steckschlüsselsatz auf Schiene
Jeu de douilles sur rail



RS4450M/10	10 Pieces Set/Rail 300mm	(g)
10, 11, 12, 13, 14, 15, 17, 19, 21, 22		717

1/2"

Hand Sockets
Hand Steckschlüssel
Douilles à main

4300M / 4300A

6-point Deep Sockets
6-kant Steckschlüssel, lang
Douilles longues, 6-pans

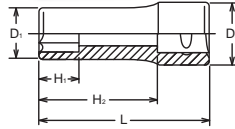

4300M 4305M (mm)	D ₁ (mm)	D ₂ (mm)	H ₁ (mm)	H ₂ (mm)	L (mm)	(g)	(pcs.)
8	13.2	21	9	59	77	76	10
9	13.8	21	10	59	77	82	10
10	15.3	21	11	59	77	82	10
11	16.5	21	12	59	77	86	10
12	17.8	21	13	59	77	92	10
13	19	21.8	14	59	77	106	10
14	20.3	21.8	15	59	77	115	10
15	21.5	21.8	16	59	77	123	10
16	22.8	22	17	59	77	141	10
17	24	23	18	59	77	139	10
18	25	24	19	59	77	149	10
19	26.5	25	20	58	77	165	10
20	27.8	26	21	58	77	183	10
21	29	27	23	58	77	190	10
22	30	28	27	57	77	200	10
23	31.5	29	27	57	77	233	10
24	32.8	30	27	57	77	249	10
25	34	31	27	57	77	270	10
26	35	32	27	56	77	279	10
27	36.5	33	28	56	77	303	10
28	37.8	34	28	56	77	331	10
29	39	35	28	55	77	357	10
30	40	36	34	55	77	342	10
31	41.5	37	34	55	77	384	10
32	42.8	38	34	55	77	405	10
33	44.2	39	35	54	77	420	5
34	45.2	40	35	54	77	442	5
35	46.2	40	35	53	77	458	5
36	47.2	41	35	53	77	484	5
37	48.2	42	38	53	77	475	5
38	49	44	38	53	77	490	5

4305M / 4305A

12-point Deep Sockets
12-kant Steckschlüssel, lang
Douilles longues, 12-pans

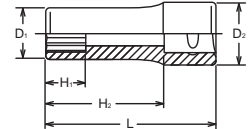

4300A 4305A (inch)	D ₁ (mm)	D ₂ (mm)	H ₁ (mm)	H ₂ (mm)	L (mm)	(g)	(pcs.)
5/16	13.2	21	9	59	77	76	10
3/8	14.6	21	10	59	77	82	10
7/16	16.5	21	12	59	77	86	10
1/2	19	21.8	14	59	77	106	10
9/16	20.3	21.8	15	59	77	115	10
19/32	21.5	21.8	16	59	77	123	10
5/8	22.8	22	17	59	77	141	10
21/32	24	23	18	59	77	139	10
11/16	25	24	19	59	77	149	10
3/4	26.5	25	20	58	77	165	10
25/32	27.8	26	21	58	77	183	10
13/16	29	27	23	58	77	190	10
7/8	30	28	27	57	77	200	10
15/16	32.8	30	27	57	77	249	10
31/32	34	31	27	57	77	270	10
1	35	32	27	56	77	279	10
1. 1/16	36.5	33	28	56	77	303	10
1. 1/8	37.8	34	28	56	77	331	10
1. 3/16	40	36	34	55	77	342	10
1. 1/4	42.8	38	34	55	77	405	10
1. 5/16	44.2	39	35	54	77	420	5
1. 3/8	46.2	40	35	54	77	422	5
1. 7/16	47.2	41	35	53	77	484	5
1. 1/2	49	44	38	53	77	523	5
1.13/16	59	48	38	51	77	791	2

RS4300M/10	10 Pieces Set/Rail 300mm	(g)
10, 11, 12, 13, 14, 15, 17, 19, 21, 22		1,415

RS4305M/10	10 Pieces Set/Rail 300mm	(g)
10, 11, 12, 13, 14, 15, 17, 19, 21, 22		1,415

RS4300M /12	12 Pieces Set/Rail 300mm	(g)
10, 12, 13, 14, 15, 16, 17, 18, 19, 20, 21, 22		1,825

RS4300A/10	10 Pieces Set/Rail 300mm	(g)
3/8, 7/16, 1/2, 9/16, 5/8, 11/16, 3/4, 13/16, 7/8, 15/16		1,600

RS4305A/10	10 Pieces Set/Rail 300mm	(g)
3/8, 7/16, 1/2, 9/16, 5/8, 11/16, 3/4, 13/16, 7/8, 15/16		1,600

RS4300M/10



Socket Set on Rail
Steckschlüsselsatz auf Schiene
Jeu de douilles sur rail

RS4305M/10



RS4300M/12



Socket Set on Rail
Steckschlüsselsatz auf Schiene
Jeu de douilles sur rail



RS4300A/10



Socket Set on Rail
Steckschlüsselsatz auf Schiene
Jeu de douilles sur rail

RS4305A/10



Hand Sockets Hand Steckschlüssel Douilles à main

1/2"

Z-SERIES
HAND
TITANIUM
SCREWDRIVERS ACCESSORIES
IMPACT
SLEEVE-DRIVE
PROTECTOR
INDUSTRIAL
AUTOMOTIVE
CONSTRUCTION MOTORCYCLE
SPARE PART

4310M

Surface Drive Deep Sockets
Surface Drive Steckschlüssel, lang
Douilles longues, Surface Drive

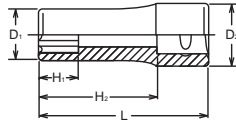
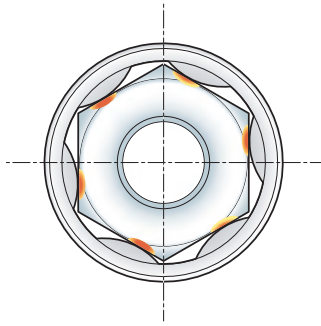

4310M (mm)	D ₁ (mm)	D ₂ (mm)	H ₁ (mm)	H ₂ (mm)	L (mm)	(g)	(pcs.)
8	13.2	21	9	59	77	79	10
9	13.8	21	10	59	77	82	10
10	15.3	21	11	59	77	82	10
11	16.5	21	12	59	77	86	10
12	17.8	21	13	59	77	92	10
13	19	21.8	14	59	77	106	10
14	20.3	21.8	15	59	77	115	10
15	21.5	21.8	16	59	77	123	10
16	22.8	22	17	59	77	141	10
17	24	23	18	59	77	139	10
18	25	24	19	59	77	149	10
19	26.5	25	20	58	77	165	10
20	27.8	26	21	58	77	183	10
21	29	27	23	58	77	190	10
22	30	28	27	57	77	200	10
23	31.5	29	27	57	77	233	10
24	32.8	30	27	57	77	249	10
25	34	31	27	57	77	270	10
26	35	32	27	56	77	279	10
27	36.5	33	28	56	77	303	10
28	37.8	34	28	56	77	334	10
29	39	35	28	55	77	357	10
30	40	36	34	55	77	342	10
31	41.5	37	34	55	77	384	10
32	42.8	38	34	55	77	405	10
34	45.2	40	35	54	77	442	5

RS4310M/10

Socket Set on Rail
Steckschlüsselsatz auf Schiene
Jeu de douilles sur rail



RS4310M/10	10 Pieces Set/Rail 300mm	(g)
10, 11, 12, 13, 14, 15, 17, 19, 21, 22		1,415

4325

TORX® Deep Sockets
TORX® Steckschlüssel, lang
Douilles longues TORX®

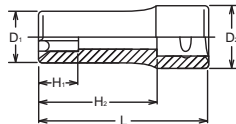

4325 (E)	D ₁ (mm)	D ₂ (mm)	H ₁ (mm)	H ₂ (mm)	L (mm)	(g)	(pcs.)
E 8	10.7	21	7	59	77	68	10
E10	13.2	21	8.2	59	77	99	10
E11	13.8	21	8.7	59	77	84	10
E12	14.6	21	9.3	59	77	99	10
E14	16.5	21	10.6	59	77	103	10
E16	19	21.8	11.8	59	77	107	10
E18	20.3	21.8	13	59	77	118	10
E20	22.8	22	14.4	59	77	141	10
E22	25	24	15.5	59	77	188	10
E24	26.6	25	17	59	77	215	10

RS4325/7

Socket Set on Rail
Steckschlüsselsatz auf Schiene
Jeu de douilles sur rail



RS4325/7	7 Pieces Set/Rail 200mm	(g)
E10, E12, E14, E16, E18, E20, E24		900

TORX® (E)

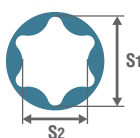

E	E4	E5	E6	E7	E8	E10	E11	E12	E14	E16	E18	E20	E22	E24	E26	E28	E30	E32
S ₁ (ref. mm)	3.7	4.6	5.6	6.1	7.4	9.3	9.9	11.0	12.8	14.6	16.5	18.3	20.1	22.0	23.7	25.5	27.3	29.0
S ₂ (ref. mm)	2.7	3.3	4.0	4.3	5.3	6.8	7.1	7.9	9.2	10.5	11.9	13.2	14.8	15.7	17.5	18.3	20.0	21.3

4300M(L120) (mm)	D ₁ (mm)	D ₂ (mm)	H ₁ (mm)	H ₂ (mm)	L (mm)	(g)	(pcs.)
8	13.2	21	9	102	120	120	5
10	15.3	21	11	102	120	138	5
12	17.8	21	13	102	120	157	5
14	20.3	21.8	15	102	120	193	5
16	22.8	22	17	102	120	210	5

4300M (L120) 6-point Extra Deep Sockets 6-kant Steckschlüssel, extra lang Douilles extra longues 6-pans

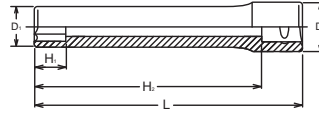

4325(L140) (E)	D ₁ (mm)	D ₂ (mm)	H ₁ (mm)	H ₂ (mm)	L (mm)	(g)	(pcs.)
E 8	10.7	21	7	122	140	110	5
E10	13.2	21	8.2	122	140	140	5
E12	14.6	21	9.3	122	140	160	5
E14	16.5	21	10.6	122	140	180	5

4325 (L140) TORX® Extra Deep Sockets TORX® Steckschlüssel, extra lang Douilles extra longues TORX®

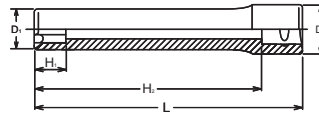

4325(L140) (E)	D ₁ (mm)	D ₂ (mm)	H ₁ (mm)	H ₂ (mm)	L (mm)	(g)	(pcs.)
E 8(2B)	10.7	21	6.6	122	140	110	5
E10(2B)	13.2	21	7.4	122	140	140	5
E12(2B)	14.6	21	9	122	140	160	5
E14(2B)	16.5	21	9.8	122	140	180	5

For Cylinder head bolt



NUT GRIP®

4325 (L140)-2B TORX® Sockets Nut Grip® TORX® Steckschlüssel mit 2-facher Kugelhalterung Douilles TORX® à deux billes de retenue

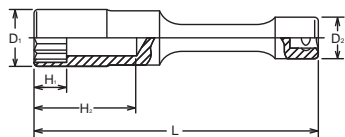
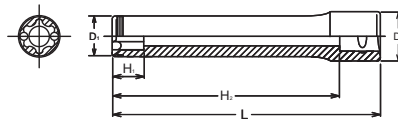

4117M-125 / -250 Extended Sockets Schaftsteckschlüssel Douilles rallongées



4117M-125 (mm)	D ₁ (mm)	D ₂ (mm)	H ₁ (mm)	H ₂ (mm)	L (mm)	(g)	(pce.)
13	18.7	24	13	59	125	213	1
14	20.2	24	14	59	125	227	1
17	24	24	17	59	125	274	1
19	26.9	24	19	59	125	279	1
21	28.5	24	21	59	125	291	1
22	30	24	22	59	125	323	1
24	32	24	24	59	125	361	1
27	36.5	24	27	59	125	439	1
30	40	24	30	59	125	461	1
32	42	24	32	59	125	498	1

4117M-250 (mm)	D ₁ (mm)	D ₂ (mm)	H ₁ (mm)	H ₂ (mm)	L (mm)	(g)	(pce.)
13	18.7	24	13	59	250	412	1
14	20.2	24	14	59	250	423	1
17	24	24	17	59	250	469	1
19	26.9	24	19	59	250	484	1
21	28.5	24	21	59	250	496	1
22	30	24	22	59	250	516	1
24	32	24	24	59	250	560	1
27	36.5	24	27	59	250	641	1
30	40	24	30	59	250	663	1
32	42	24	32	59	250	698	1

Z-SERIES
HAND
TITANIUM
ACCESSORIES
SCREWDRIVERS
IMPACT
SLEEVE-DRIVE
PROTECTOR
INDUSTRIAL
AUTOMOTIVE
MOTORCYCLE
CONSTRUCTION
SPARE PART

4440M / 4440A

6-point Universal Sockets
6-kant Gelenk-Einsätze
Douilles articulées, 6-pans

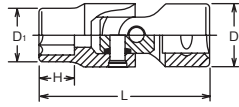
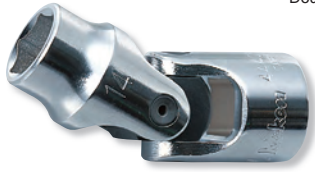

4440A (inch)	D ₁ (mm)	D ₂ (mm)	H (mm)	L (mm)	(g)	(pcs.)
3/8	14.8	25	8.8	63	155	10
7/16	16.5	25	10	65	158	10
1/2	19	25	11.4	66	152	10
9/16	20.3	25	11.4	66	151	10
5/8	22.8	25	13	68	150	10
11/16	24.6	25	14	69	153	10
3/4	26.5	25	15	71	170	10
7/8	30.3	25	16	72	185	5

4440M (mm)	D ₁ (mm)	D ₂ (mm)	H (mm)	L (mm)	(g)	(pcs.)
9	14	25	8.3	63	150	10
10	15.3	25	8.8	63	155	10
11	16.5	25	10	65	158	10
12	17.8	25	10.5	65	151	10
13	19	25	11.4	66	152	10
14	20.3	25	11.4	66	151	10
15	21.5	25	13	68	149	10
16	22.8	25	13	68	150	10
17	24	25	14	69	150	10
18	25.3	25	14	69	150	10
19	26.5	25	15	71	170	10
20	27.8	25	15	71	173	5
21	29	25	16	72	176	5
22	30.3	25	16	72	185	5

4445M / 4445A

12-point Universal Sockets
12-kant Gelenk-Einsätze
Douilles articulées, 12-pans

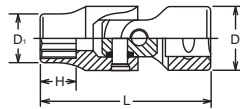

4445A (inch)	D ₁ (mm)	D ₂ (mm)	H (mm)	L (mm)	(g)	(pcs.)
3/8	14.8	25	8.8	63	155	10
7/16	16.5	25	10	65	158	10
1/2	19	25	11.4	66	152	10
9/16	20.3	25	11.4	66	151	10
5/8	22.8	25	13	68	150	10
11/16	24.6	25	14	69	153	10

4445M (mm)	D ₁ (mm)	D ₂ (mm)	H (mm)	L (mm)	(g)	(pcs.)
10	15.3	25	8.8	63	155	10
12	17.8	25	10.5	65	151	10
13	19	25	11.4	66	152	10
14	20.3	25	11.4	66	151	10
17	24	25	14	69	150	10
19	26.5	25	15	71	170	10
21	29	25	16	72	176	5
22	30.3	25	16	72	185	5

4440T

TORX® Universal Sockets
TORX® Gelenk-Einsätze
Douilles articulées, TORX®

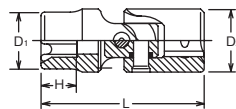

4440T (E)	D ₁ (mm)	D ₂ (mm)	H (mm)	L (mm)	(g)	(pcs.)
E10	13.2	25	8.2	62	145	10
E12	15	25	9.3	63	147	10
E14	16.3	25	10.6	65	148	10
E16	18.8	25	11.8	65	150	10
E18	20.4	25	13	67	153	10

4000-60 (PH)

PH Bit Sockets
Steckschlüssel für Kreuzschlitzschrauben, PH
Douilles tournevis pour vis à empreinte PH

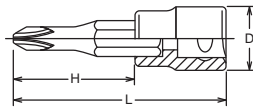

4000 (PH)	D (mm)	H (mm)	L (mm)	(g)	(pcs.)
2	22	23.5	60	65	10
3	22	23.5	60	65	10
4	22	23.5	60	67	10

4000-60 (PZ)

PZ Bit Sockets
Steckschlüssel für Kreuzschlitzschrauben, PZ
Douilles tournevis pour vis à empreinte PZ

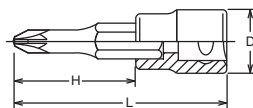

4000-60 (PZ)	D (mm)	H (mm)	L (mm)	(g)	(pcs.)
PZ2	22	23.5	60	65	10
PZ3	22	23.5	60	65	10

4005-60

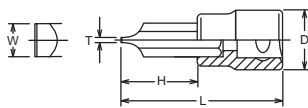

Bit Sockets for Slotted Heads
Steckschlüssel für Schlitzschrauben
Douilles tournevis pour vis à fente



4005	TxW (mm)	D (mm)	H (mm)	L (mm)	(g)	(pcs.)
8	1.2x 8	22	23.5	60	65	10
10	1.6x10	22	23.5	60	75	10
12	2.0x12	23	23.5	60	111	10
14	2.5x14	24	23.5	60	133	10
16	2.5x16	24	23.5	60	133	10

1/2" Hand Sockets Hand Steckschlüssel Douilles à main

4010M-50 / -75 / -100 / -160 4010A-60

 Inhex Bit Sockets
Steckschlüssel für Innensechskant-Schrauben
 Douilles tournevis pour vis 6-pans creux

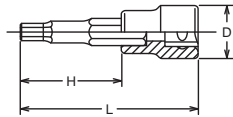

4010M-50 (mm)	D (mm)	H (mm)	L (mm)	(g)	(pcs.)
4	22	13.5	50	61	10
5	22	13.5	50	62	10
6	22	13.5	50	64	10
7	22	13.5	50	65	10
8	22	13.5	50	66	10
9	22	13.5	50	73	10
10	22	13.5	50	75	10
12	23	13.5	50	105	10
13	24	13.5	50	120	10
14	24	13.5	50	120	10
16	25	15	50	150	10
17	25	15	50	150	10
18	27	15	50	200	5
19	27	15	50	200	5

4010M-75 (mm)	D (mm)	H (mm)	L (mm)	(g)	(pcs.)
4	22	38.5	75	69	10
5	22	38.5	75	70	10
6	22	38.5	75	72	10
7	22	38.5	75	73	10
8	22	38.5	75	74	10
9	22	38.5	75	90	10
10	22	38.5	75	92	10
12	23	38.5	75	130	10
13	24	38.5	75	150	10
14	24	38.5	75	150	10
16	25	35	75	180	10
17	25	35	75	180	10
18	27	33	75	230	5
19	27	33	75	230	5

4010M-100 (mm)	D (mm)	H (mm)	L (mm)	(g)	(pcs.)
4	22	63.5	100	77	10
5	22	63.5	100	78	10
6	22	63.5	100	80	10
7	22	63.5	100	82	10
8	22	63.5	100	84	10
9	22	63.5	100	105	10
10	22	63.5	100	109	10
12	23	63.5	100	155	10
13	24	63.5	100	180	5
14	24	63.5	100	180	5
16	25	60	100	250	5
17	25	60	100	250	5
18	27	58	100	300	5
19	27	58	100	300	5

4010M-160 (mm)	D (mm)	H (mm)	L (mm)	(g)	(pcs.)
4	22	123.5	160	103	10
5	22	123.5	160	104	10
6	22	123.5	160	106	10
7	22	123.5	160	108	10
8	22	123.5	160	110	10
10	22	123.5	160	126	10
12	23	123.5	160	180	5
14	24	123.5	160	260	5
17	25	120	160	360	5
19	27	118	160	415	5



4010A-60 (inch)	D (mm)	H (mm)	L (mm)	(g)	(pcs.)
5/32	22	23.5	60	57	10
3/16	22	23.5	60	57	10
7/32	22	23.5	60	59	10
1/4	22	23.5	60	63	10
9/32	22	23.5	60	65	10
5/16	22	23.5	60	67	10
11/32	22	23.5	60	75	10
3/8	22	23.5	60	76	10
7/16	23	23.5	60	101	10
1/2	24	23.5	60	124	10
9/16	25	20	60	127	10
5/8	25	20	60	174	10
3/4	27	18	60	220	5



RS4010M/10-L50	10 Pieces Set/Rail 300mm	(g)
4, 5, 6, 7, 8, 10, 12, 14, 17, 19		968

RS4010M/10-L75	10 Pieces Set/Rail 300mm	(g)
4, 5, 6, 7, 8, 10, 12, 14, 17, 19		1,207

RS4010A/10-L60	10 Pieces Set/Rail 300mm	(g)
3/16, 7/32, 1/4, 5/16, 3/8, 7/16, 1/2, 9/16, 5/8, 3/4		1,080

RS4010M/10-L50  Socket Set on Rail
Steckschlüsselsatz auf Schiene
RS4010M/10-L75  Jeu de douilles sur rail
RS4010A/10-L60 



Hand Sockets Hand Steckschlüssel Douilles à main

1/2"

Z-SERIES
HAND
TITANIUM
SCREWDRIVERS ACCESSORIES
IMPACT
SLEEVE-DRIVE
PROTECTOR
INDUSTRIAL
AUTOMOTIVE
MOTORCYCLE
CONSTRUCTION
SPARE PART

4012M-43 / -60 / -75 / -100



Inhex Sockets
Steckschlüssel für Innensechskant-Schrauben ⚠
Douilles tournevis pour vis 6-pans creux

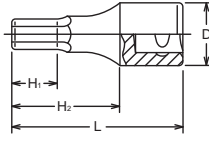

4012M-43 (mm)	D (mm)	H ₁ (mm)	H ₂ (mm)	L (mm)	(g)	(pcs.)
4	21.1	11.5	23	43	40	10
5	21.1	11.5	23	43	46	10
6	21.1	11.5	23	43	42	10
7	21.1	11.5	23	43	46	10
8	21.1	11.5	23	43	49	10
9	21.1	11.5	23	43	63	10
10	23	11.5	23	43	63	10
11	25	11.5	23	43	74	10
12	25	11.5	23	43	81	10
13	25	11.5	23	43	85	10
14	25	11.5	23	43	88	10
15	26	11.5	23	43	91	10
16	26	11.5	23	43	100	10
17	26	11.5	23	43	101	10
18	26	11.5	23	43	106	10
19	26	11.5	23	43	110	10
20	26	11.5	23	43	130	10
21	26	11.5	23	43	140	10
22	26	11.5	23	43	145	10
23	28	11.5	23	43	167	10
24	28	11.5	23	43	170	10
27	32	11.5	23	43	226	10

4012M-60 (mm)	D (mm)	H ₁ (mm)	H ₂ (mm)	L (mm)	(g)	(pcs.)
4	21.1	15.5	38	60	49	10
5	21.1	15.5	38	60	55	10
6	21.1	15.5	38	60	56	10
7	21.1	15.5	38	60	60	10
8	21.1	15.5	38	60	64	10
9	21.1	15.5	38	60	78	10
10	23	15.5	38	60	78	10
11	25	15.5	38	60	100	10
12	25	15.5	38	60	107	10
13	25	15.5	38	60	111	10
14	25	15.5	38	60	122	10
15	26	15.5	38	60	125	10
16	26	15.5	38	60	134	10
17	26	15.5	38	60	141	10
18	26	15.5	38	60	153	10
19	26	15.5	38	60	159	10
21	26	15.5	38	60	197	10
22	26	22.5	38	60	205	10
23	28	22.5	38	60	242	10
24	28	22.5	38	60	245	10

4012M-75 (mm)	D (mm)	H ₁ (mm)	H ₂ (mm)	L (mm)	(g)	(pcs.)
4	21.1	15.5	53	75	52	10
5	21.1	15.5	53	75	58	10
6	21.1	15.5	53	75	62	10
7	21.1	15.5	53	75	70	10
8	21.1	15.5	53	75	74	10
9	21.1	15.5	53	75	88	10
10	23	15.5	53	75	94	10
11	25	15.5	53	75	119	10
12	25	15.5	53	75	122	10
13	25	15.5	53	75	137	10
14	25	15.5	53	75	148	10
15	26	15.5	53	75	151	10
16	26	15.5	53	75	171	10
17	26	15.5	53	75	184	10
18	26	15.5	53	75	196	10
19	26	15.5	53	75	212	10
22	26	22.5	53	75	266	10
24	27.9	22.5	53	75	315	10

4012M-100 (mm)	D (mm)	H ₁ (mm)	H ₂ (mm)	L (mm)	(g)	(pcs.)
4	24	15.5	78	100	75	10
5	24	15.5	78	100	81	10
6	24	15.5	78	100	85	10
7	24	15.5	78	100	93	10
8	24	15.5	78	100	97	10
9	24	15.5	78	100	111	10
10	24	15.5	78	100	117	10
11	24	15.5	78	100	142	10
12	24	15.5	78	100	143	10
13	24	15.5	78	100	158	10
14	24	15.5	78	100	169	10
15	24	15.5	78	100	172	10
16	24	15.5	78	100	192	5
17	24	15.5	78	100	215	5
18	24	15.5	78	100	227	5
19	24	15.5	78	100	243	5

RS4012M/10-L60





Socket Set on Rail
Steckschlüsselsatz auf Schiene
Jeu de douilles sur rail



RS4012M/10-L60	10 Pieces set/Rail 300mm	(g)
4, 5, 6, 7, 8, 10, 12, 14, 17, 19		910

⚠ 4012M/A are for hand use only.
Do not use with a power or impact wrench.
Nicht auf Maschinenschrauben verwenden.
À ne pas utiliser sur des machines

4012A-43 / -60 / -75 / -100

 Inhex Sockets
Steckschlüssel für Innensechskant-Schrauben 
Douilles tournevis pour vis 6-pans creux

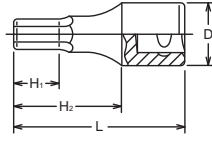

4012A-43 (inch)	D (mm)	H ₁ (mm)	H ₂ (mm)	L (mm)	(g)	(pcs.)
5/32	21.1	11.5	23	43	40	10
3/16	21.1	11.5	23	43	46	10
7/32	21.1	11.5	23	43	42	10
1/4	21.1	11.5	23	43	43	10
9/32	21.1	11.5	23	43	46	10
5/16	21.1	11.5	23	43	49	10
11/32	21.1	11.5	23	43	63	10
3/8	23	11.5	23	43	59	10
7/16	25	11.5	23	43	74	10
1/2	25	11.5	23	43	85	10
9/16	25	11.5	23	43	88	10
5/8	26	11.5	23	43	100	10
3/4	26	11.5	23	43	110	10
7/8	26	11.5	23	43	141	10

4012A-60 (inch)	D (mm)	H ₁ (mm)	H ₂ (mm)	L (mm)	(g)	(pcs.)
5/32	21.1	15.5	38	60	49	10
3/16	21.1	15.5	38	60	55	10
7/32	21.1	15.5	38	60	56	10
1/4	21.1	15.5	38	60	57	10
9/32	21.1	15.5	38	60	60	10
5/16	21.1	15.5	38	60	64	10
11/32	21.1	15.5	38	60	78	10
3/8	23	15.5	38	60	74	10
7/16	25	15.5	38	60	100	10
1/2	25	15.5	38	60	111	10
9/16	25	15.5	38	60	122	10
5/8	26	15.5	38	60	134	10
3/4	26	15.5	38	60	159	10
7/8	26	22.5	38	60	202	10

4012A-75 (inch)	D (mm)	H ₁ (mm)	H ₂ (mm)	L (mm)	(g)	(pcs.)
5/32	21.1	15.5	53	75	52	10
3/16	21.1	15.5	53	75	58	10
7/32	21.1	15.5	53	75	62	10
1/4	21.1	15.5	53	75	65	10
9/32	21.1	15.5	53	75	70	10
5/16	21.1	15.5	53	75	74	10
11/32	21.1	15.5	53	75	88	10
3/8	23	15.5	53	75	86	10
7/16	25	15.5	53	75	119	10
1/2	25	15.5	53	75	137	10
9/16	25	15.5	53	75	148	10
5/8	26	15.5	53	75	171	10
3/4	26	15.5	53	75	212	10
7/8	26	22.5	53	75	262	10

4012A-100 (inch)	D (mm)	H ₁ (mm)	H ₂ (mm)	L (mm)	(g)	(pcs.)
5/32	24	15.5	78	100	75	10
3/16	24	15.5	78	100	81	10
7/32	24	15.5	78	100	85	10
1/4	24	15.5	78	100	88	10
9/32	24	15.5	78	100	93	10
5/16	24	15.5	78	100	97	10
11/32	24	15.5	78	100	111	10
3/8	24	15.5	78	100	109	10
7/16	24	15.5	78	100	142	10
1/2	24	15.5	78	100	158	10
9/16	24	15.5	78	100	169	10
5/8	24	15.5	78	100	192	5
3/4	24	15.5	78	100	243	5

RS4012A/10-L60	10 Pieces set/Rail 300mm	(g)
3/16, 7/32, 1/4, 5/16, 3/8, 7/16, 1/2, 9/16, 5/8, 3/4		950

RS4012A/10-L60   Socket Set on Rail
Steckschlüsselsatz auf Schiene
Jeu de douilles sur rail



 4012M/A are for hand use only.
Do not use with a power or impact wrench.
Nicht auf Maschinenschrauben verwenden.
À ne pas utiliser sur des machines

Hand Sockets Hand Steckschlüssel 1/2"

4020-60 / -100 / -120 / -140

 XZN Bit Sockets
Steckschlüssel für XZN Schrauben
Douilles tournevis pour empreinte XZN

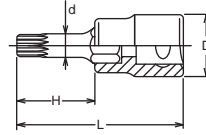

4020-60 (XZN)	D (mm)	d (mm)	H (mm)	L (mm)	(g)	(pcs.)
M 5	22	7.8	23.5	60	60	10
M 6	22	7.8	23.5	60	61	10
M 8	22	7.8	23.5	60	63	10
M10	23	11.9	23.5	60	93	10
M12	23	11.9	23.5	60	97	10
M14	24	13.9	23.5	60	105	10
M16	25	16.9	20	60	165	10
M18	25	17.9	20	60	170	10

4020-120 (XZN)	D (mm)	d (mm)	H (mm)	L (mm)	(g)	(pcs.)
M 5	22	7.8	83.5	120	86	10
M 6	22	7.8	83.5	120	87	10
M 8	22	7.8	83.5	120	89	10
M10	23	11.9	83.5	120	152	10
M12	23	11.9	83.5	120	156	10
M14	24	13.9	83.5	120	164	5

4020-100 (XZN)	D (mm)	d (mm)	H (mm)	L (mm)	(g)	(pcs.)
M 5	22	7.8	63.5	100	77	10
M 6	22	7.8	63.5	100	78	10
M 8	22	7.8	63.5	100	80	10
M10	23	11.9	63.5	100	132	10
M12	23	11.9	63.5	100	136	10
M14	24	13.9	63.5	100	144	5
M16	25	16.9	60	100	250	5
M18	27	17.9	60	100	300	5

4020-140 (XZN)	D (mm)	d (mm)	H (mm)	L (mm)	(g)	(pcs.)
M 5	22	7.8	103.5	140	95	10
M 6	22	7.8	103.5	140	96	10
M 8	22	7.8	103.5	140	98	10
M10	23	11.9	103.5	140	172	5
M12	23	11.9	103.5	140	176	5
M14	24	13.9	103.5	140	184	5

RS4020/6-L60 RS4020/6-L100

 Socket Set on Rail
Steckschlüsselsatz auf Schiene
Jeu de douilles sur rail









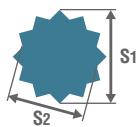



RS4020/6-L60	6 Pieces Set/Rail 150mm	(g)
M5, M6, M8, M10, M12, M14		500

RS4020/6-L100	6 Pieces Set/Rail 150mm	(g)
M5, M6, M8, M10, M12, M14		680

XZN



XZN		M4	M5	M6	M8	M10	M12	M14	M16	M18
S ₁	(ref. mm)	3.6	4.8	6.1	7.3	9.7	11.5	13.3	15.7	16.9
S ₂	(ref. mm)	3.1	4.1	5.1	6.1	8.1	9.7	11.2	13.2	14.2

	 PH	 PZ	 Slotted	 HEX	 HEX (ball point)	 Triple Square (XZN)	 TORX® (T)	 TORX® (TH)	 TORXplus® (IP)	 TORXplus® (IPR)	 Ribe-CV
1/4"	No.2000 series	No.2000(PZ) series	No.2005 series	No.2010M/A series	No.2011M series	No.2020 series	No.2025 series	No.2025(TH) series	No.2025(IP) series	No.2025(IPR) series	—
3/8"	No.3000 series	No.3000(PZ) series	No.3005 series	No.3010M/A No.3012M/A No.3015M series	No.3011M series	No.3020 series	No.3025 series	No.3025(TH) series	No.3025(IP) series	No.3025(IPR) series	No.3027 series
1/2"	No.4000 series	No.4000(PZ) series	No.4005 series	No.4010M/A No.4012M/A series	—	No.4020 series	No.4025 series	—	No.4025(IP) series	—	No.4027 series

4025-60 (T)	D (mm)	H (mm)	L (mm)	(g)	(pcs.)
T15	22	23.5	60	58	10
T20	22	23.5	60	59	10
T25	22	23.5	60	60	10
T27	22	23.5	60	60	10
T30	22	23.5	60	60	10
T40	22	23.5	60	62	10
T45	22	23.5	60	64	10
T50	22	23.5	60	74	10
T55	23	23.5	60	96	10
T60	24	23.5	60	122	10
T70	24	23.5	60	135	10
T80	24	20	60	168	10

4025-100 (T)	D (mm)	H (mm)	L (mm)	(g)	(pcs.)
T20	22	73.5	100	76	10
T25	22	73.5	100	76	10
T27	22	73.5	100	77	10
T30	22	73.5	100	77	10
T40	22	73.5	100	78	10
T45	22	73.5	100	80	10
T50	22	73.5	100	98	10
T55	23	73.5	100	132	10
T60	24	73.5	100	170	5
T70	24	73.5	100	175	5

4025-140 (T)	D (mm)	H (mm)	L (mm)	(g)	(pcs.)
T20	22	103.5	140	94	10
T25	22	103.5	140	95	10
T27	22	103.5	140	95	10
T30	22	103.5	140	95	10
T40	22	103.5	140	97	10
T45	22	103.5	140	99	10
T50	22	103.5	140	129	10
T55	23	103.5	140	175	5
T60	24	103.5	140	229	5
T70	24	103.5	140	245	5
T80	24	100	140	320	5

RS4025/9-L60	9 Pieces Set/Rail 250mm	(g)
T20, T25, T27, T30, T40, T45, T50, T55, T60		700

4025-60 / -100 / -140 (T)

TORX® Bit Sockets
TORX® Bit-Steckschlüssel
Douilles tournevis, TORX®

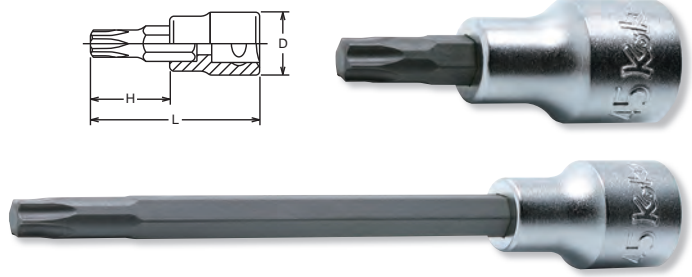

RS4025/9-L60



Socket Set on Rail
Steckschlüsselsatz auf Schiene
Jeu de douilles sur rail



TORX® (T)

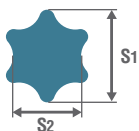

T	T8	T9	T10	T15	T20	T25	T27	T30	T40	T45	T50	T55	T60	T70	T80	T90	T100
S ₁ (ref. mm)	2.3	2.5	2.7	3.3	3.9	4.5	5.0	5.6	6.7	7.9	8.9	11.3	13.3	15.6	17.6	20.0	22.2
S ₂ (ref. mm)	1.7	1.8	2.0	2.3	2.8	3.2	3.6	4.0	4.8	5.6	6.2	8.0	9.5	11.1	12.7	14.2	15.8

4025-60	D (mm)	H (mm)	L (mm)	(g)	(pcs.)
T35	22	23.5	60	96	10

For T35 Special screws

4025-60-T35

Bit Socket
Bit-Steckschlüssel
Douille tournevis

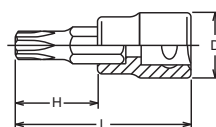

Z-SERIES
HAND
TITANIUM
SCREWDRIVERS
ACCESSORIES
IMPACT
SLEEVE-DRIVE
PROTECTOR
INDUSTRIAL
AUTOMOTIVE
CONSTRUCTION
MOTORCYCLE
SPARE PART

4025-60 / -100 (IP)

TORXPLUS® Bit Sockets
TORXPLUS® Bit-Steckschlüssel
Douilles tournevis, TORXPLUS®

TORXplus



4025-60 (IP)	D (mm)	H (mm)	L (mm)	(g)	(pcs.)
20IP	22	23.5	60	60	10
25IP	22	23.5	60	60	10
27IP	22	23.5	60	60	10
30IP	22	23.5	60	60	10
40IP	22	23.5	60	60	10
45IP	22	23.5	60	64	10
50IP	22	23.5	60	74	10
55IP	23	23.5	60	96	10
60IP	24	23.5	60	122	10
70IP	24	23.5	60	170	10

RS4025/9-IP

Socket Set on Rail
Steckschlüsselsatz auf Schiene
Jeu de douilles sur rail



4025-100 (IP)	D (mm)	H (mm)	L (mm)	(g)	(pcs.)
40IP	22	63.5	100	79	10
45IP	22	63.5	100	81	10
50IP	22	63.5	100	100	10
55IP	23	63.5	100	133	10
60IP	24	63.5	100	172	5
70IP	25	63.5	100	241	5

RS4025/9-IP	9 Pieces set/Rail 250mm	(g)
20IP, 25IP, 27IP, 30IP, 40IP, 45IP, 50IP, 55IP, 60IP		700

TORXPLUS® (IP)

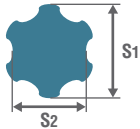

IP	8IP	9IP	10IP	15IP	20IP	25IP	27IP	30IP	40IP	45IP	50IP	55IP	60IP	70IP
S ₁ (ref. mm)	2.3	2.5	2.7	3.3	3.9	4.5	5.0	5.6	6.7	7.9	8.9	11.3	13.3	15.6
S ₂ (ref. mm)	1.8	1.9	2.1	2.5	3.0	3.4	3.9	4.3	5.2	6.2	6.9	9.0	10.4	12.3

4027-60 / -100 / -140

Bit Sockets for Ribe Screws
Steckschlüsselklingen für Ribe Schrauben
Douilles tournevis pour écrous profil Ribe

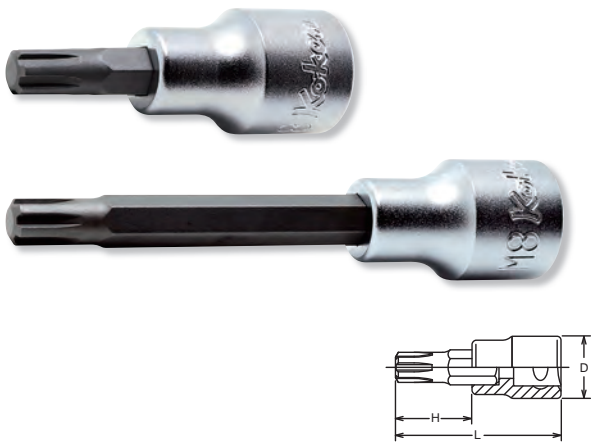

4027-60	D (mm)	H (mm)	L (mm)	(g)	(pcs.)
M 5	22	23.5	60	60	10
M 6	22	23.5	60	62	10
M 7	22	23.5	60	63	10
M 8	22	23.5	60	64	10
M 9	22	23.5	60	70	10
M10	22	23.5	60	74	10
M12	23	23.5	60	96	10
M13	24	23.5	60	116	10
M14	24	23.5	60	122	10
M16	24	25	60	135	10

4027-100	D (mm)	H (mm)	L (mm)	(g)	(pcs.)
M 5	22	63.5	100	67	10
M 6	22	63.5	100	68	10
M 7	22	63.5	100	75	10
M 8	22	63.5	100	81	10
M 9	22	63.5	100	90	10
M10	22	63.5	100	101	10
M12	23	63.5	100	134	10
M13	24	63.5	100	155	5
M14	24	63.5	100	173	5
M16	24	60	100	241	5

RS4027/7-L60

Socket Set on Rail
Steckschlüsselsatz auf Schiene
Jeu de douilles sur rail



4027-140	D (mm)	H (mm)	L (mm)	(g)	(pcs.)
M 8	22	103.5	140	98	10
M10	22	103.5	140	127	10
M12	23	103.5	140	171	5
M14	24	103.5	140	226	5
M16	24	100	140	320	5

RS4027/7-L60	7 Pieces set/Rail 200mm	(g)
M5, M6, M8, M10, M12, M14, M16		600

Ribe CV

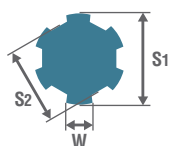

CV	M5	M6	M7	M8	M9	M10	M12	M13	M14	M16
W (ref. mm)	1.2	1.3	1.4	1.8	2.0	2.3	2.6	3.1	3.2	3.6
S ₁ (ref. mm)	5.0	6.0	7.0	8.0	9.0	10.0	12.0	13.0	14.0	16.0
S ₂ (ref. mm)	3.8	4.5	5.0	6.0	7.1	7.4	9.0	11.0	10.4	11.9

4110M (mm)	D (mm)	H (mm)	L (mm)	(g)	(pcs.)
8	24	10	32	57	10
10	24	10	32	62	10
10.5	24	10	32	64	10
12	24	10	32	64	10
13	24	10	32	66	10
13.5	24	10	32	67	10
New 14	24.2	10	32	68	10
19	25	15	37	101	10
20	26	15	37	114	10

4110A (inch)	D (mm)	H (mm)	L (mm)	(g)	(pcs.)
3/8	24	10	32	62	10
1/2	24	10	32	64	10

4101	TxW (mm)	D (mm)	L (mm)	(g)	(pcs.)
1	2.7x18.6	22	40	59	10
2	3.7x24	24	40	79	10
3	3.7x30	30	40	128	10

4137	D ₁ (mm)	D ₂ (mm)	L (mm)	(g)	(pcs.)
4137	13	22	38	53	10

For DIN3126 C6.3 Bits
Für DIN3126 C6.3 Bits
Pour DIN3126 C6.3 Embouts

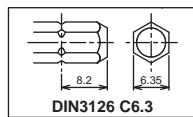

4138	D ₁ (mm)	D ₂ (mm)	L (mm)	(g)	(pcs.)
4138	16	22	38	62	10

For DIN3126 C8 Bits
Für DIN3126 C8 Bits
Pour DIN3126 C8 Embouts

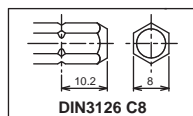

4110M / 4110A

4-point Male Sockets
Oldienst-Steckschlüssel, Vierkant
Douilles mâles 4-pans

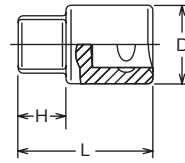

4101

Sockets for Slotted Heads
Steckschlüssel für Schlitzschrauben
Douilles tournevis pour vis à fente

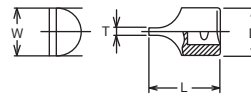

4137

Bit Holder
Klingenhalter
Porte-embouts

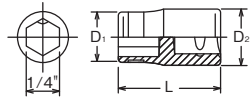

4138

Bit Holder
Klingenhalter
Porte-embouts

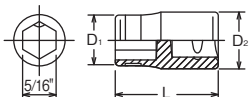

Hand Sockets Hand Steckschlüssel Douilles à main

1/2"

Z-SERIES
HAND
TITANIUM
SCREWDRIVERS
ACCESSORIES
IMPACT
SLEEVE-DRIVE
PROTECTOR
INDUSTRIAL
AUTOMOTIVE
MOTORCYCLE
CONSTRUCTION
SPARE PART

3749S-1/2 Reversible Ratchet Short
Knarre, verstellbar
Cliquet, réversible



* Renewal Kits → 3749SRK-1/2 → P318

3749SB-1/2 Reversible Ratchet short with quick release button
Knarre, verstellbar mit Entriegelungsknopf
Cliquet, réversible avec bouton de débrayage

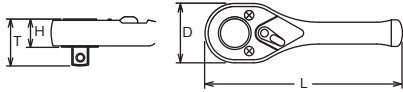

* Renewal Kits → 3749SBRK-1/2 → P318

	D (mm)	T (mm)	H (mm)	L (mm)	(g)	(pcs.)
3749S-1/2	34	29	14.4	110	200	5
3749SB-1/2	34	29	14.4	110	200	5

⚠ Reversible Ratchet with quick release button has less strength compared with normal ratchet due to the technical design. Make sure to use the ratchet correctly.

Die Umschaltknarre mit Entriegelungsknopf hat aufgrund der technischen Konstruktion eine geringere Festigkeit als eine normale Ratsche. Stellen Sie sicher, dass Sie die Ratsche richtig verwenden.

Le cliquet réversible avec bouton de libération rapide a une résistance moindre que le cliquet normal en raison de sa conception technique. Veillez à utiliser le cliquet correctement.

4752J Reversible Ratchet
Knarre, verstellbar
Cliquet, réversible



* Renewal Kits → 4752RK → P319

[L/R Marking]



A pointer and L/R markings on the ratchet head indicate the turning direction. The reduced diameter of the head allows easier access in tight spots.

Eine L/R Markierung auf dem Knarrenkopf zeigt die gerade eingestellte Drehrichtung an. Der geringe Kopfdurchmesser erleichtert das Arbeiten auch an schwer zugänglichen Stellen.

Un marquage L/R sur la tête de cliquet indique le sens de rotation.

Le diamètre de tête réduit et facilite le travail dans les endroits difficilement accessibles.

4752N Reversible Ratchet
Knarre, verstellbar
Cliquet, réversible

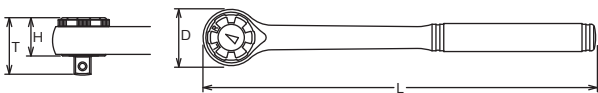

	D (mm)	T (mm)	H (mm)	L (mm)	(g)	(pcs.)
4752J	35	38.8	24.5	250	470	1
4752N	35	38.8	24.5	250	480	1

GEAR TEETH



4749series



4753series



4750series



4752series



4774series





* Renewal Kits → 4750RK → P318

4750J Reversible Ratchet
Knarre, verstellbar
Cliquet, réversible



* Renewal Kits → 4750RK → P318

4750P Reversible Ratchet
Knarre, verstellbar
Cliquet, réversible



* Renewal Kits → 4750RK → P318

4750N Reversible Ratchet
Knarre, verstellbar
Cliquet, réversible



	D (mm)	T (mm)	H (mm)	L (mm)	(g)	(pce.)
4750J	38	35.9	21.3	250	508	1
4750P	38	35.9	21.3	250	553	1
4750N	38	35.9	21.3	250	548	1

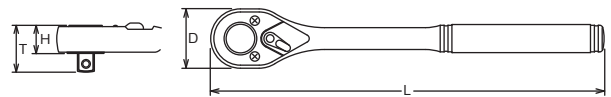

* Renewal Kits → 4750BRK → P318

4750JB Reversible Ratchet with quick release button
Knarre, verstellbar mit Entriegelungsknopf
4750PB Cliquet, réversible avec bouton de débrayage
4750NB



	D (mm)	T (mm)	H (mm)	L (mm)	(g)	(pce.)
4750JB	38	35.9	21.3	250	508	1
4750PB	38	35.9	21.3	250	553	1
4750NB	38	35.9	21.3	250	548	1

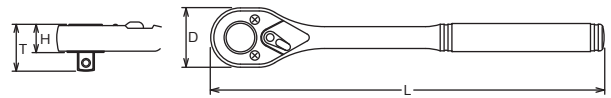

⚠ Reversible Ratchet with quick release button has less strength compared with normal ratchet due to the technical design. Make sure to use the ratchet correctly.

Die Umschaltknarre mit Entriegelungsknopf hat aufgrund der technischen Konstruktion eine geringere Festigkeit als eine normale Ratsche. Stellen Sie sicher, dass Sie die Ratsche richtig verwenden.

Le cliquet réversible avec bouton de libération rapide a une résistance moindre que le cliquet normal en raison de sa conception technique. Veuillez à utiliser le cliquet correctement.

[4750 series]

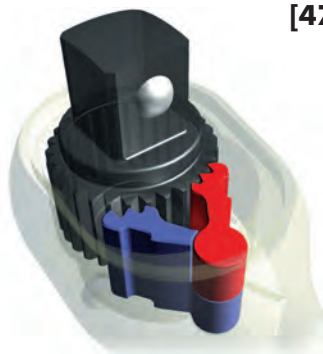

Two dogs are set in the same axis and the three teeth hold the ratchet gear. The enlarged contact area produces an about 10% higher torque value and the S.O.D.H system provides smooth and light movements.

Die scharnierartig eingelagerten Sperrklinken haben jetzt jeweils drei Zähne im Eingriff. Die dadurch vergrößerte Greiffläche erhöht das maximale Drehmoment um ca. 10%. Auch diese Knarre besticht durch ihren leichten und geschmeidigen Lauf.

Les deux rochets étant placés sur le même axe, les trois dents de l'engrenage sont engagées en permanence. Ce système assure une augmentation de 10% du couple maximum admissible. Ce cliquet se caractérise également par son fonctionnement souple et sans à-coup.

Hand Sockets Hand Steckschlüssel Douilles à main

1/2"

Z-SERIES
HAND
TITANIUM
SCREWDRIVERS ACCESSORIES
IMPACT
SLEEVE-DRIVE
PROTECTOR
INDUSTRIAL
AUTOMOTIVE
MOTORCYCLE
CONSTRUCTION
SPARE PART

4753J Reversible Ratchet
Knarre, verstellbar
Cliquet, réversible



* Renewal Kits → 4753RK → P318

4753P Reversible Ratchet
Knarre, verstellbar
Cliquet, réversible



* Renewal Kits → 4753RK → P318

4753N Reversible Ratchet
Knarre, verstellbar
Cliquet, réversible



* Renewal Kits → 4753RK → P318

D4753J Reversible Ratchet
Knarre, verstellbar
Cliquet, réversible



* Renewal Kits → 4753RK → P318

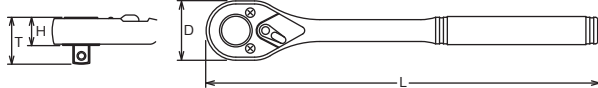

Special ratchet, surface phosphatised, no chrome flaking possible
Sonderknarre Oberfläche phosphatiert, keine Chromabplatzungen möglich
Cliquet spécial surface phosphatée, pas d'écaillage du chrome possible

	D (mm)	T (mm)	H (mm)	L (mm)	(g)	(pce.)
4753J	38	36.2	21.6	250	545	1
4753P	38	36.2	21.6	250	570	1
4753N	38	36.2	21.6	250	595	1
D4753J	38	36.2	21.6	250	510	1

4753JB Reversible Ratchet with quick release button
Knarre, verstellbar mit Entriegelungsknopf

4753PB

4753NB

Cliquet, réversible avec bouton de débrayage



* Renewal Kits → 4753BRK → P318

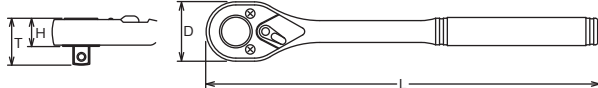

Reversible Ratchet with Quick Release Button :

Sockets and accessories are safely locked. By pushing the button the sockets or extension bars are released from the ratchet.

Umstellbare Knarre mit Entriegelungsknopf :

Steckschlüssel und Zubehörteile werden sicher und fest gehalten. Bei Drücken des Knopfes lösen sich die Teile.

Cliquet réversible avec bouton de débrayage :

Les douilles et accessoires ne peuvent plus tomber. Une pression du pouce sur le bouton suffit pour les libérer.



! Reversible Ratchet with quick release button has less strength compared with normal ratchet due to the technical design. Make sure to use the ratchet correctly.

Die Umschaltknarre mit Entriegelungsknopf hat aufgrund der technischen Konstruktion eine geringere Festigkeit als eine normale Ratsche. Stellen Sie sicher, dass Sie die Ratsche richtig verwenden.

Le cliquet réversible avec bouton de libération rapide a une résistance moindre que le cliquet normal en raison de sa conception technique. Veillez à utiliser le cliquet correctement.

	D (mm)	T (mm)	H (mm)	L (mm)	(g)	(pce.)
4753JB	38	36.2	21.6	250	545	1
4753PB	38	36.2	21.6	250	570	1
4753NB	38	36.2	21.6	250	595	1



* Renewal Kits → 4749RK → P318

4749J-380 Reversible Ratchet (long)
4749N-380 Verstellbare Knarre, lang
Cliquet réversible, long



	D (mm)	T (mm)	H (mm)	L (mm)	(g)	(pce.)
4749J-380	44.6	33	18.4	380	743	1
4749N-380	44.6	33	18.4	380	753	1

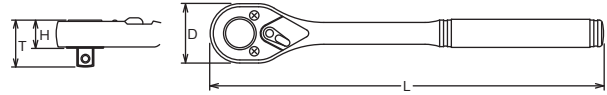

* Renewal Kits → 4753RK → P318

4753P-410 Reversible Ratchet (long) ⚠
Verstellbare Knarre, lang
Cliquet réversible, long



	D (mm)	T (mm)	H (mm)	L (mm)	(g)	(pce.)
4753P-410	38	36.2	21.6	410	790	1

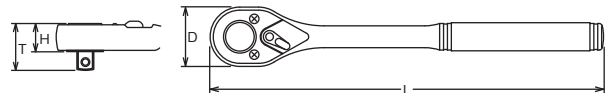

⚠ 4753P-410 have longer handle than standard, and can be loaded to excessive torque value. In the interest of your own safety always apply load evenly and progressively to avoid breakage and possible injury.



* Renewal Kits → 4753RK → P318

4774J Flexible Ratchet, reversible
4774P Gelenk-Knarre, verstellbar
4774N Cliquet, articulé, réversible

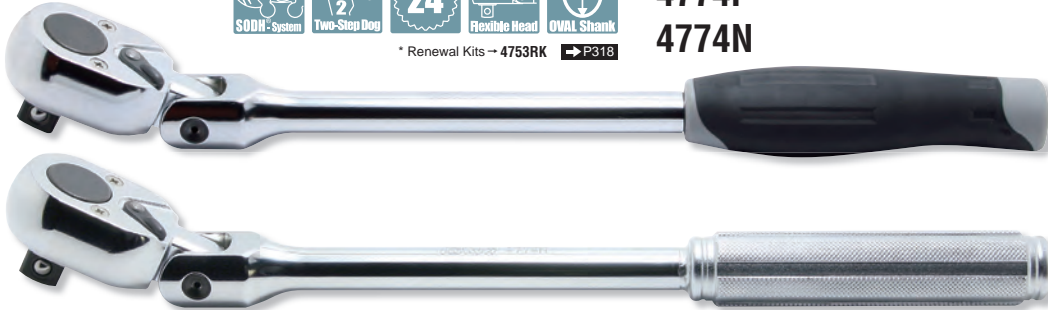

	D (mm)	T (mm)	H (mm)	L (mm)	(g)	(pce.)
4774J	38	36.2	21.6	330	685	1
4774P	38	36.2	21.6	330	700	1
4774N	38	36.2	21.6	330	700	1

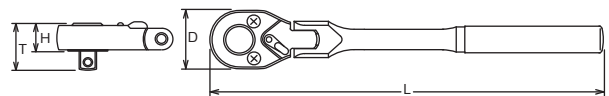

* Renewal Kits → 4753RK → P318

4774P-450 Flexible Ratchet (long), reversible ⚠
Gelenk-Knarre lang, verstellbar
Cliquet articulé long, réversible



	D (mm)	T (mm)	H (mm)	L (mm)	(g)	(pce.)
4774P-450	38	36.2	21.6	450	790	1

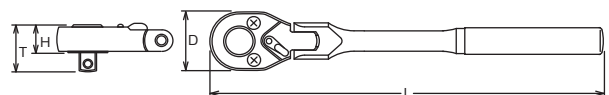

⚠ 4774P-450 has longer handle than standard, and can be loaded to excessive torque value. In the interest of your own safety always apply load evenly and progressively to avoid breakage and possible injury.

Hand Sockets Hand Steckschlüssel Douilles à main

1/2"

Z-SERIES
HAND
TITANIUM
SCREWDRIVERS ACCESSORIES
IMPACT
SLEEVE-DRIVE
PROTECTOR
INDUSTRIAL
AUTOMOTIVE
MOTORCYCLE
CONSTRUCTION
SPARE PART

4774JB Flexible Ratchet, reversible with quick release button
4774PB Gelenk-Knarre, verstellbar mit Entriegelungsknopf
4774NB Cliquet, articulé, réversible avec bouton de débrayage



* Renewal Kits → 4753BRK → P318

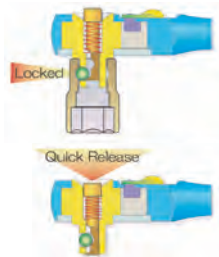
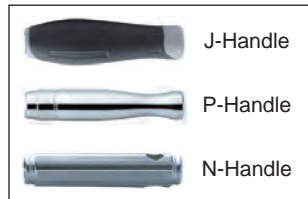
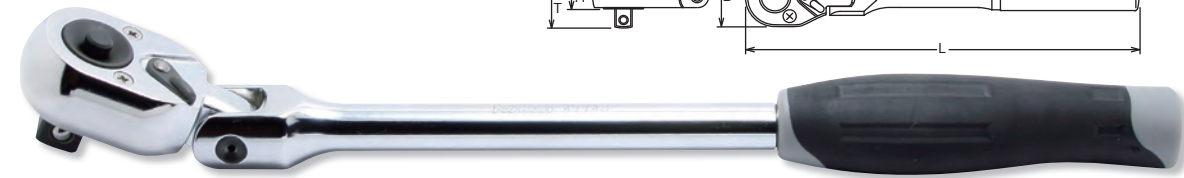

	D (mm)	T (mm)	H (mm)	L (mm)	(g)	(pcs.)
4774JB	38	36.2	21.6	330	685	1
4774PB	38	36.2	21.6	330	700	1
4774NB	38	36.2	21.6	330	700	1

Reversible Ratchet with Quick Release Button :

Sockets and accessories are safely locked. By pushing the button the sockets or extension bars are released from the ratchet.

Umstellbare Knarre mit Entriegelungsknopf :

Steckschlüssel und Zubehörteile werden sicher und fest gehalten. Bei Drücken des Knopfes lösen sich die Teile.

Cliquet réversible avec bouton de débrayage :

Les douilles et accessoires ne peuvent plus se libérer. Une pression du pouce sur le bouton suffit pour les extraire.

⚠ Reversible Ratchet with quick release button has less strength compared with normal ratchet due to the technical design. Make sure to use the ratchet correctly.
 Die Umschaltknarre mit Entriegelungsknopf hat aufgrund der technischen Konstruktion eine geringere Festigkeit als eine normale Ratsche. Stellen Sie sicher, dass Sie die Ratsche richtig verwenden.
 Le cliquet réversible avec bouton de libération rapide a une résistance moindre que le cliquet normal en raison de sa conception technique. Veillez à utiliser le cliquet correctement.

4755 Ratchet Adaptor
Aufsteckknarre
Cliquet adaptable

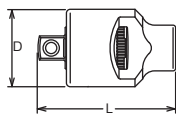

* Renewal Kits → 4755RK → P319

	D (mm)	L (mm)	(g)	(pcs.)
4755	33.5	65	270	5

4756 Quick Spinner
Rändel-Drehscheibe
Lanceur

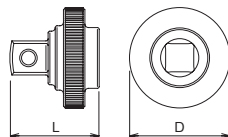

	D (mm)	L (mm)	(g)	(pcs.)
4756	38	34.5	95	10

4768J-380 / -450 / -600 Hinge Handles
Gelenkgriffe
Poignées articulées



* Renewal Kits → 4768RK → P321



4768P-380 / -450 / -600

Hinge Handles
Gelenkgriffe
Poignées articulées



* Renewal Kits → 4768RK → P321

⚠ 4768-450/600 have longer handle than standard, and can be loaded to excessive torque value. Please use carefully.

Der 4768-450 und 4768-600 hat einen längeren Griff als die Standardausführung und kann mit einem zu hohen Drehmoment belastet werden. Bitte vorsichtig verwenden.

Dû au fait que les manches des 4768-450 et 4768-600 sont plus longues que le standard, il y a un risque d'une surcharge excessive lors du serrage. Pour éviter casse et blessure, veuillez serrer d'une façon régulière et progressive.

	D (mm)	L (mm)	(g)	(pcs.)
4768J-380	28	380	600	1
4768J-450	28	450	690	1
4768J-600	28	600	1120	1
4768P-380	28	380	665	2
4768P-450	28	450	748	2
4768P-600	28	600	1170	1

	D (mm)	L (mm)	(g)	(pcs.)
4760-35	24	35	56	10
4760-50	24	50	92	10
4760-75	24	75	138	10
4760-100	24	100	158	5
4760-125	24	125	194	5
4760-150	24	150	266	5
4760-200	24	200	295	5
4760-250	24	250	358	5
4760-300	24	300	492	2
4760-400	24	400	650	1
4760-500	24	500	808	1
4760-600	24	600	968	1
4760-900	24	900	1430	1
4760-1000	24	1000	1593	1

4760 Extension Bars Verlängerungen Rallonges

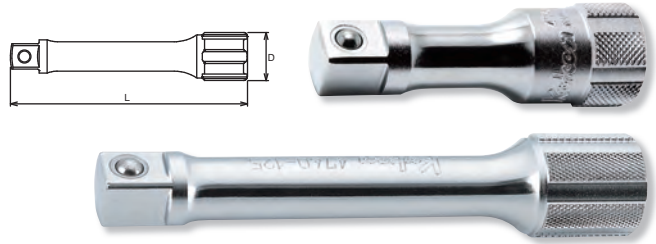

PK4760/5 5 Pieces Set/△=1,050g

PLASTIC TRAY

Extension Bars

4760 Extension Bars
50, 75, 125, 150, 250

Rotation and general handling of extensions with oily hands is greatly improved with the **Koken** developed 6 point knurling. Also the **Koken** 6 point knurling stops the extensions from rolling around the work area.

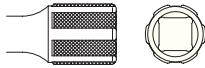

Durch die von **Koken** entwickelte 6 fache Rändelung wird die Handhabung deutlich erleichtert. Außerdem wird das Herumrollen der Verlängerungen wirksam verhindert.

La manipulation des rallonges est grandement facilitée par le profil moleté développé par **Koken**. Ce même profil empêche le roulement intempêtif des rallonges sur le plan de travail.

PK4760/5 Extension Bars in Plastic Box Verlängerungen in Kunststoff-Kassette Rallonges en boîte plastique



	D (mm)	L (mm)	(g)	(pcs.)
4763-50	24	50	95	10
4763-75	24	75	111	10
4763-125	24	125	157	5
4763-150	24	150	181	5
4763-250	24	250	357	5
4763-300	24	300	480	2
4763-400	24	400	650	1

New



WOBBLE-FIX
EXTENSION BAR

4763 Wobble-Fix Extension Bars Winkel-Verlängerungen Rallonges angulaires

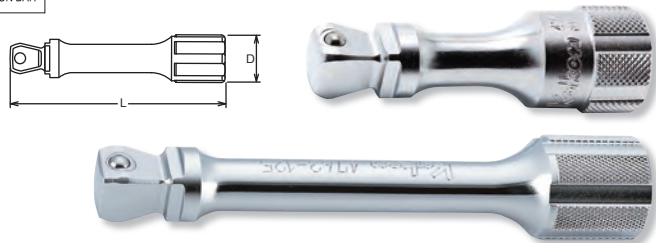

⚠ The Wobble-Fix Extension Bar has less strength than normal extension bar due to its specific design with a reduced square drive. Make sure to use it correctly.

Die Wobble-Fix Verlängerungen haben aufgrund ihrer speziellen Konstruktion mit einem reduzierten Vierkanttrieb eine geringere Festigkeit als eine normale Verlängerung. Achten Sie darauf, sie richtig zu verwenden.

La barre d'extension angulaire est moins résistante qu'une barre d'extension normale en raison de sa conception spécifique avec un carré d'entraînement réduit. Veuillez l'utiliser correctement.

PK4763/5 5 Pieces Set/△=950g

PLASTIC TRAY

Extension Bars

4763 Wobble-Fix Extension Bars
50, 75, 125, 150, 250

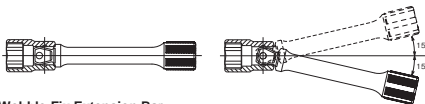

Wobble-Fix Extension Bar

Two way usage

- In a fixed position, as a normal extension bar
- In a half-fixed position, as a flexible extension bar providing a 15° angle operation

Winkel-Verlängerungen

Winkelverlängerungen lassen sich in zwei Einstellungen verwenden

- voll eingesteckt und starr,
- halb eingesteckt, mit einem Arbeitswinkel von 15°.

Rallonges angulaires

Deux utilisations possibles

- comme rallonge normale, dans une position fixe
- comme une rallonge angulaire avec une possibilité d'inclinaison jusqu'à 15°

PK4763/5 Wobble-Fix Extension Bars in Plastic Box Winkel Verlängerungen in Kunststoff-Kassette Rallonges angulaires en boîte plastique



Hand Sockets
Hand Steckschlüssel
Douilles à main

1/2"

Z-SERIES
HAND
TITANIUM
SCREWDRIVERS ACCESSORIES
IMPACT
SLEEVE-DRIVE
PROTECTOR
INDUSTRIAL
AUTOMOTIVE
MOTORCYCLE
CONSTRUCTION
SPARE PART

4770 Universal Joint
Gelenk-Einsatz
Cardan universel

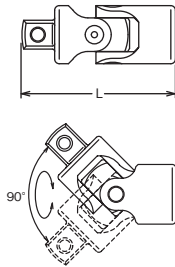

	L (mm)	(g)	(pcs.)
4770	62.4	150	10

4771 Universal Joint
Gelenk-Einsatz
Joint articulé

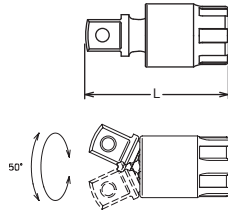

	L (mm)	(g)	(pcs.)
4771	57.7	113	10

4780-400 Speed Handle
Winde
Vilebrequin

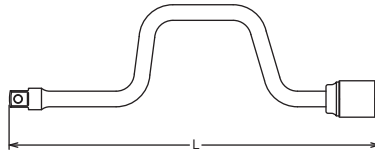
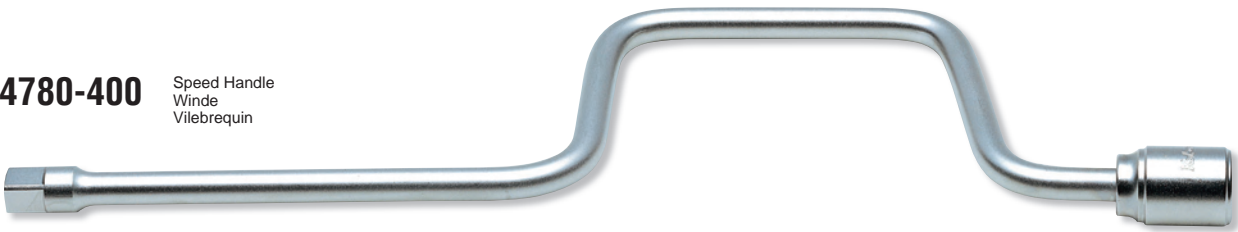

	L (mm)	(g)	(pce.)
4780	400	644	1

4781N-450 Flexible Speed Handle
Gelenkgriff-Winde
Vilebrequin

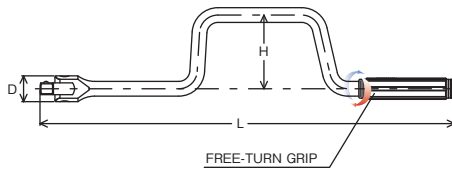

* Renewal Kits → 4768RK → P321

	D (mm)	H (mm)	L (mm)	(g)	(pce.)
4781N-450	28	80	450	1000	1

4785 T-Handle
T-Griff
Poignée coulissante

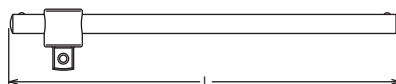

	L (mm)	(g)	(pcs.)
4785	300	410	2





4747 L-Handle
L-Griff
Poignées en L



	L ₁ (mm)	L ₂ (mm)	(g)	(pcs.)
4747	263	53	470	1

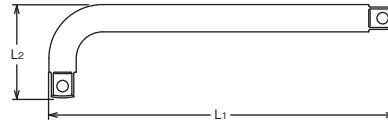

4788-250 / -300 / -450 ⚠ L-Handles
L-Griffe
Poignées en L

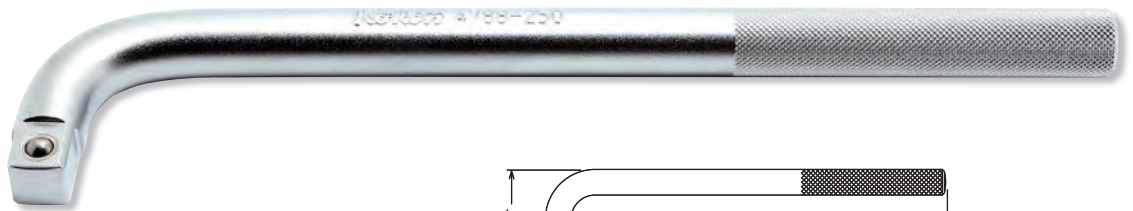

	L ₁ (mm)	L ₂ (mm)	(g)	(pcs.)
4788-250	250	53	417	2
4788-300	300	53	503	1
4788-450	450	53	745	1



⚠ 4788-450 have longer handle than standard, and can be loaded to excessive torque value. In the interest of your own safety always apply load evenly and progressively to avoid breakage and possible injury.

	(sq.)	(sq.)	L (mm)	(g)	(pcs.)
4433A-35	1/2"	3/8"	35	50	10
4433A-75	1/2"	3/8"	75	120	10
4433A-125	1/2"	3/8"	125	164	5
4433A-250	1/2"	3/8"	250	275	5
4433A-600	1/2"	3/8"	600	530	1

Items in this catalogue marked ⚠ can be loaded to torque values which may cause breakage.

In the interest of your own safety always apply load evenly and progressively to avoid breakage and possible injury.

Die mit ⚠ gekennzeichneten Artikel können bei Überbelastungen zu Bruch gehen. Aus Gründen Ihrer Sicherheit, sollten die betreffenden Werkzeuge nie ruckartig sondern nach und nach belastet werden, um Bruch und damit verbundene, mögliche Verletzungen zu vermeiden.

Il est possible d'appliquer aux articles marqués ⚠ des couples de serrage susceptibles d'occasionner leur rupture. Pour votre propre sécurité, veuillez toujours appliquer la charge d'une manière uniforme et progressive. Ceci pour éviter ruptures et accidents.

	(sq.)	(sq.)	L (mm)	(g)	(pcs.)
4466A	1/2"	3/4"	42	108	10

4433A Adaptors
Verbindungsstücke
Réducteurs

Warranty 290Nm
Garantie 290Nm
Garantie 290Nm ⚠

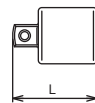

4466A Adaptor
Verbindungsstück
Réducteurs

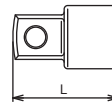

Hand Sockets
Hand Steckschlüssel
Douilles à main **1/2"**

Z-SERIES
HAND
TITANIUM
SCREWDRIVERS
ACCESSORIES
IMPACT
SLEEVE-DRIVE
PROTECTOR
INDUSTRIAL
AUTOMOTIVE
MOTORCYCLE
CONSTRUCTION
SPARE PART

4223M-01 Socket Sets
Steckschlüssel Sätze
4223M-06 Jeux de clés à douilles



4223M-01 15 Pieces Set/⚖️=2,600g
4223M-06 15 Pieces Set/⚖️=2,600g

METAL CASE:W415xH120xT50mm

Sockets		Accessories	
(4223M-01)			4753J
4401M 6-pt. Sockets	10, 11, 12, 13, 14, 15, 16, 17, 18, 19, 21, 22		4760-125
(4223M-06)			4770
4406M 12-pt. Sockets	10, 11, 12, 13, 14, 15, 16, 17, 18, 19, 21, 22		

4238AM Socket Sets
Steckschlüssel Sätze
Jeux de clés à douilles



4238AM 38 Pieces Set/⚖️=8,050g

METAL CASE:W446xH266xT50mm

Sockets		Accessories	
4405M 12-pt. Sockets	10, 11, 12, 13, 14, 15, 16, 17, 18, 19, 21, 22, 23, 24, 26, 27, 30, 32		4753N
(4238AM)			4760-125
4405A 12-pt. Sockets	3/8, 7/16, 1/2, 9/16, 5/8, 11/16, 3/4, 13/16, 7/8, 15/16, 1.1/16, 1.1/8, 1.1/4		4760-250
4300C Spark Plug Socket	20.8		4770
			4780
			4785

S4240M-01 Display Stands
S4240A-00 Ausstellungsstände
S4240M-06 Présentoirs
S4240A-05



S4240M-01 4401M 117 Pieces Set/⚖️=13,000g
S4240M-06 4406M 117 Pieces Set/⚖️=13,000g

DISPLAY STAND:W510xH150xT230mm

Sockets		
10mm:9pcs	16mm:9pcs	24mm:6pcs
11mm:9pcs	17mm:8pcs	27mm:5pcs
12mm:9pcs	19mm:7pcs	30mm:5pcs
13mm:9pcs	21mm:7pcs	32mm:4pcs
14mm:9pcs	22mm:6pcs	
15mm:9pcs	23mm:6pcs	





S4240A-00 4400A 103 Pieces Set/⚖️=13,000g
S4240A-05 4405A 103 Pieces Set/⚖️=13,000g

DISPLAY STAND:W510xH150xT230mm

Sockets		
3/8" :9pcs	11/16":8pcs	1" :5pcs
7/16":9pcs	3/4" :7pcs	1.1/16":5pcs
1/2" :9pcs	13/16":7pcs	1.1/8" :5pcs
9/16":9pcs	7/8" :6pcs	1.3/16":5pcs
5/8" :9pcs	15/16":6pcs	1.1/4" :4pcs

4241M-01	28 Pieces Set/△=6,500g
4241M-06	28 Pieces Set/△=6,500g
4241M-10	28 Pieces Set/△=6,500g

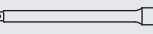
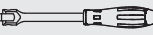
METAL CASE:W446xH266xT50mm

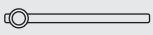





Sockets	Accessories
(4241M-01) 4401M 6-pt. Sockets 10, 11, 12, 13, 14, 15, 16, 17, 18, 19, 20, 21, 22, 23, 24, 25, 26, 27, 28, 29, 30, 32	 4753J  4760-125  4760-250  4768J-380
(4241M-06) 4406M 12-pt. Sockets 10, 11, 12, 13, 14, 15, 16, 17, 18, 19, 20, 21, 22, 23, 24, 25, 26, 27, 28, 29, 30, 32	 4770  4785
(4241M-10) 4410M Surface Drive Sockets 10, 11, 12, 13, 14, 15, 16, 17, 18, 19, 20, 21, 22, 23, 24, 25, 26, 27, 28, 29, 30, 32	

4241M-01 Socket Sets
4241M-06 Steckschlüssel Sätze
4241M-10 Jeux de clés à douilles

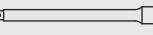

4241A-00	19 Pieces Set/△=4,900g
4241A-05	19 Pieces Set/△=4,900g

METAL CASE:W445xH190xT50mm





Sockets	Accessories
(4241A-00) 4400A 6-pt. Sockets 3/8, 7/16, 1/2, 9/16, 5/8, 11/16, 3/4, 13/16, 7/8, 15/16, 1.1/16, 1.1/8, 1.1/4	 4753J  4760-125  4760-250  4768J-380
(4241A-05) 4405A 12-pt. Sockets 3/8, 7/16, 1/2, 9/16, 5/8, 11/16, 3/4, 13/16, 7/8, 15/16, 1.1/16, 1.1/8, 1.1/4	 4770  4785

4241A-00 Socket Sets
4241A-05 Steckschlüssel Sätze
Jeux de clés à douilles

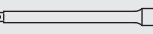

4249M-01	20 Pieces Set/△=4,800g
4249M-06	20 Pieces Set/△=4,800g

METAL CASE:W445xH190xT50mm

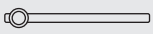



Sockets	Accessories
(4249M-01) 4401M 6-pt. Sockets 10, 11, 12, 13, 14, 15, 16, 17, 18, 19, 21, 22, 24, 27, 30	 4753J  4760-125  4760-250
(4249M-06) 4406M 12-pt. Sockets 10, 11, 12, 13, 14, 15, 16, 17, 18, 19, 21, 22, 24, 27, 30	 4770  4785

4249M-01 Socket Sets
4249M-06 Steckschlüssel Sätze
Jeux de clés à douilles

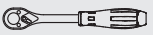

4250M-01	18 Pieces Set/△=4,700g
4250M-06	18 Pieces Set/△=4,700g
4250M-10	18 Pieces Set/△=4,700g

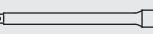
METAL CASE:W445xH190xT50mm

Sockets	Accessories
(4250M-01) 4401M 6-pt. Sockets 10, 11, 12, 13, 14, 15, 17, 19, 22, 24, 27, 30, 32	 4753J  4760-125  4760-250
(4250M-06) 4406M 12-pt. Sockets 10, 11, 12, 13, 14, 15, 17, 19, 22, 24, 27, 30, 32	 4770  4785
(4250M-10) 4410M Surface Drive Sockets 10, 11, 12, 13, 14, 15, 17, 19, 22, 24, 27, 30, 32	

4250M-01 Socket Sets
4250M-06 Steckschlüssel Sätze
4250M-10 Jeux de clés à douilles



Hand Sockets
Hand Steckschlüssel 1/2"
Douilles à main

Z-SERIES
HAND
TITANIUM
SCREWDRIVERS ACCESSORIES
IMPACT
SLEEVE-DRIVE
PROTECTOR
INDUSTRIAL
AUTOMOTIVE
MOTORCYCLE
CONSTRUCTION
SPARE PART

4251M-01 Socket Sets
Steckschlüssel Sätze
Jeux de clés à douilles
4251M-06
4251M-10
4251A-00
4251A-05



4251M-01	22 Pieces Set/⚖️=3,200g
4251M-06	22 Pieces Set/⚖️=3,200g
4251M-10	22 Pieces Set/⚖️=3,200g
4251A-00	18 Pieces Set/⚖️=2,700g
4251A-05	18 Pieces Set/⚖️=2,700g

METAL CASE:W330xH68xT48mm

Sockets	
(4251M-01) 4401M 6-pt. Sockets	10, 11, 12, 13, 14, 15, 16, 17, 18, 19, 20, 21, 22, 23, 24, 25, 26, 27, 28, 29, 30, 32
(4251M-06) 4406M 12-pt. Sockets	
(4251M-10) 4410M Surface Drive Sockets	
(4251A-00) 4400A 6-pt. Sockets	3/8, 7/16, 1/2, 9/16, 19/32, 5/8, 21/32, 11/16, 3/4, 25/32, 13/16, 7/8, 15/16, 1, 1.1/16, 1.1/8, 1.3/16, 1.1/4
(4251A-05) 4405A 12-pt. Sockets	

4252M-01 Socket Sets
Steckschlüssel Sätze
Jeux de clés à douilles
4252M-06
4252M-10



4252M-01	13 Pieces Set/⚖️=1,200g
4252M-06	13 Pieces Set/⚖️=1,200g
4252M-10	13 Pieces Set/⚖️=1,200g

METAL CASE:W168xH60xT42mm

Sockets	
(4252M-01) 4401M 6-pt. Sockets	10, 11, 12, 13, 14, 15, 16, 17, 18, 19, 20, 21, 22
(4252M-06) 4406M 12-pt. Sockets	
(4252M-10) 4410M Surface Drive Sockets	

4254 Socket Sets
Steckschlüssel Sätze
Jeux de clés à douilles



4254	12 Pieces Set/⚖️=1,070g
------	-------------------------

METAL CASE:W215xH80xT47mm

Sockets		Accessories	
3/8"	3425- E6, E8		4763-50
1/2"	4425- E10, E12, E14		4433A-35
3/8"	3325- E6, E8		
1/2"	4325- E10, E12, E14		

4262M-01 Socket Sets
Steckschlüssel Sätze
Jeux de clés à douilles
4262M-06
4262M-10







4262M-01	20 Pieces Set/⚖️=4,400g
4262M-06	20 Pieces Set/⚖️=4,400g
4262M-10	20 Pieces Set/⚖️=4,400g

METAL CASE:W445xH190xT50mm

Sockets		Accessories	
(4262M-01) 4401M 6-pt. Sockets	8, 10, 11, 12, 13, 14, 15, 16, 17, 18, 19, 21, 22, 24, 27		4753J
(4262M-06) 4406M 12-pt. Sockets	8, 10, 11, 12, 13, 14, 15, 16, 17, 18, 19, 21, 22, 24, 27		4760-125
(4262M-10) 4410M Surface Drive Sockets	8, 10, 11, 12, 13, 14, 15, 16, 17, 18, 19, 21, 22, 24, 27		4770
			4785

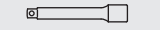
4272AM-01 29 Pieces Set/△=5,000g
4272AM-06 29 Pieces Set/△=5,000g

METAL CASE:W445xH190xT50mm

Sockets	Accessories
(4272AM-01) 4401M 6-pt. Sockets 10, 11, 12, 13, 14, 15, 16, 17, 18, 19, 21, 22, 24	 4753J
4400A 6-pt. Sockets 3/8, 7/16, 1/2, 9/16, 5/8, 11/16, 3/4, 13/16, 7/8, 15/16, 1	 4760-125
(4272AM-06) 4406M 12-pt. Sockets 10, 11, 12, 13, 14, 15, 16, 17, 18, 19, 21, 22, 24	 4760-250
4405A 12-pt. Sockets 3/8, 7/16, 1/2, 9/16, 5/8, 11/16, 3/4, 13/16, 7/8, 15/16, 1	 4770
	 4785





4272AM-01 4272AM-06

Socket Sets
Steckschlüssel Sätze
Jeux de clés à douilles

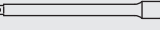

4275 24 Pieces Set/△=5,340g

METAL CASE:W445xH190xT50mm

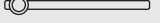
Sockets	Accessories
4406M 12-pt. Sockets 10, 11, 12, 13, 14, 15, 16, 17, 18, 19, 21, 22, 24	 4750J
4300C Spark Plug Sockets 16, 20.8	 4760-125
4300M Wheel Nut Sockets 17(L60), 19(L60), 21(L60)	 4760-250
	 4768J-380
	 4770
	 4785

4275

Socket Sets
Steckschlüssel Sätze
Jeux de clés à douilles



4276 17 Pieces Set/△=2,890g

METAL CASE:W370xH150xT50mm

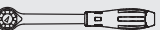
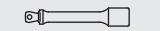
Sockets	Accessories
4010M.50 Bit Sockets 6, 7, 8, 10, 12, 14	 4752J
4025.60 TORX® Bit Sockets T20, T25, T27, T30, T40, T45, T50, T55, T60	 4763-125

4276

Socket Sets
Steckschlüssel Sätze
Jeux de clés à douilles



4277 27 Pieces Set/△=5,660g

METAL CASE:W445xH190xT50mm

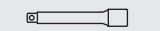
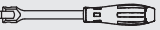
Sockets	Accessories
4406M 12-pt. Sockets 10, 12, 13, 14, 15, 16, 17, 18, 19, 21, 22, 24	 4750J
4305M 12-pt. Deep Sockets 10, 12, 13, 14, 15, 16, 17, 18, 19, 21, 22, 24	 4760-125
	 4768J-380

4277

Socket Sets
Steckschlüssel Sätze
Jeux de clés à douilles



6400M / 6400A

6-point Sockets
6-kant Steckschlüssel
Douilles 6-pans

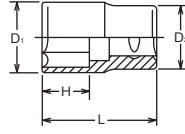

6400M 6405M (mm)	D ₁ (mm)	D ₂ (mm)	H (mm)	L (mm)	(g)	(pcs.)
14	22.1	34	11	50	160	10
16	24.6	34	12	50	167	10
17	26	34	12.5	50	175	5
18	27	34	13	50	178	5
19	28.5	34	13.5	50	179	5
20	29.5	34	14	50	185	5
21	31	34	14.5	50	185	5
22	32	34	15	50	187	5
23	33.5	34	16	50	187	5
24	34.5	34	17	50	200	5
25	36	34	17.5	50	217	5
26	37	34	18	50	222	5
27	38.5	37	19	53	254	5
28	39.5	38	19.5	53	298	5
29	41	38	20	55	292	5
30	42	38	21	55	301	5
31	43.5	38	22	57	294	5
32	44.5	40	23	57	351	5
33	46	40	23.5	57	384	5
34	47	40	24	57	397	5
35	48.5	42	24.5	59	422	5
36	49.5	42	25	59	438	5
37	51	42	25.5	59	484	5
38	52	45	26	59	523	5
39	53.5	45	26.5	59	538	5
40	54.5	45	27	62	550	5
41	56	47	28	62	633	5
42	57	47	28.5	62	652	2
43	58.5	47	29	62	659	2
44	59.5	47	29.5	62	657	2
45	61	47	30	68	734	2
46	62	47	31	68	791	2
47	63.5	48	31.5	68	816	2
48	64.5	45	32	68	800	2
50	67	48	34	68	880	2
52	69.5	53	33	72	925	2
54	72	55	33	72	1040	2
55	73.5	53	36	72	1006	2
56	74.5	53	36	72	1092	2
57	76	53	36	72	1169	2
58	77	53	36	72	1149	2
60	79.5	58	39	76	1402	2
63	83.5	58	39	76	1494	2
65	86	63	42	80	1608	2
70	92	68	45	84	1785	2
75	98.5	73	48	86	2186	1
78	102.1	73	55	86	2425	1
80	104.5	78	52	90	2475	1
85	111	78	52	90	2620	1

6405M / 6405A

12-point Sockets
12-kant Steckschlüssel
Douilles 12-pans

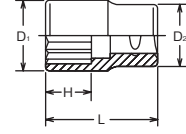

6400A 6405A (inch)	D ₁ (mm)	D ₂ (mm)	H (mm)	L (mm)	(g)	(pcs.)
5/8	24.6	34	12	50	168	10
11/16	27	34	13	50	178	5
3/4	28.5	34	13.5	50	179	5
25/32	29.5	34	14	50	185	5
13/16	31	34	14.5	50	185	5
7/8	32	34	15	50	187	5
15/16	34.5	34	17	50	200	5
31/32	36	34	17.5	50	217	5
1	37	34	18	50	222	5
1. 1/16	38.5	37	19	53	254	5
1. 1/8	41	38	20	53	292	5
1. 3/16	42	38	21	55	301	5
1. 1/4	44.5	40	23	57	351	5
1. 5/16	46	40	23.5	57	384	5
1. 3/8	48.5	42	24.5	57	422	5
1. 7/16	51	42	25.5	59	484	5
1. 1/2	52	45	26	59	523	5
1. 9/16	54.5	45	27	59	550	5
1. 5/8	56	47	28	62	633	5
1.11/16	58.5	47	29	62	659	2
1. 3/4	59.5	47	29.5	62	657	2
1.13/16	62	47	31	68	791	2
1. 7/8	64.5	45	32	68	892	2
1.15/16	66	48	32.5	68	870	2
2	68.5	52	34.5	68	949	2
2. 1/16	71	54	33	72	983	2
2. 1/8	72	55	33	72	1040	2
2. 3/16	74.5	53	36	72	1092	2
2. 1/4	76	53	36	72	1169	2
2. 5/16	78.5	53	36	72	1344	2
2. 3/8	79.5	58	39	76	1402	2
2. 7/16	82	58	39	76	1420	2
2. 1/2	84.5	58	39	76	1497	2
2. 9/16	86	63	42	80	1608	2
2. 5/8	88.5	63	42	80	1709	2
2.11/16	89.5	63	42	80	1634	2
2. 3/4	92	68	45	84	1785	2
2.13/16	94.5	68	45	84	2018	2
2. 7/8	96	68	45	84	2062	2
2.15/16	98.5	73	48	86	2186	1
3	101	73	48	86	2309	1
3. 1/8	104.5	78	52	90	2475	1

6425

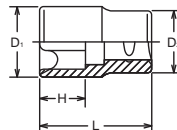

TORX® Sockets
TORX® Steckschlüssel
Douilles TORX®



6425 (E)	D ₁ (mm)	D ₂ (mm)	H (mm)	L (mm)	(g)	(pcs.)
E18	22.1	34	11.9	50	156	5
E20	24.6	34	13.3	50	166	5
E22	27.1	34	14.4	50	178	5
E24	28.6	34	16	50	185	5
E26	31.1	34	17.7	55	217	5
E28	32.1	34	24.1	60	237	5
E30	35	34	24.1	60	242	5
E32	36.1	34	24.1	60	247	5

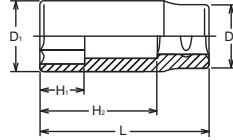

6300M / 6300A 6-point Deep Sockets 6-kant-Steckschlüssel,lang Douilles longues 6-pans





6300M 6305M (mm)	D ₁ (mm)	D ₂ (mm)	H ₁ (mm)	H ₂ (mm)	L (mm)	 (g)	 (pcs.)
17	26	34	18	64	90	278	5
18	27	34	19	64	90	281	5
19	28.5	34	20	64	90	292	5
20	29.5	34	21	64	90	334	5
21	31	34	22	64	90	343	5
22	32	34	23	64	90	347	5
23	33.5	34	24	64	90	361	5
24	34.5	34	25	64	90	352	5
25	36	34	26	64	90	369	5
26	37	34	27	64	90	384	5
27	38.5	37	28	64	90	425	5
28	39.5	38	29	63	90	470	5
29	41	38	30	63	90	503	5
30	42	38	31	63	90	503	5
31	43.5	38	32	62	90	517	5
32	44.5	40	34	62	90	544	5
33	46	40	34	62	90	557	5
34	47	40	35	61	90	570	5
35	48.5	42	36	61	90	622	5
36	49.5	42	37	61	90	631	2
38	52	45	39	60	90	710	2
40	54.5	45	41	60	90	742	2
41	56	47	42	59	90	802	2
42	57	47	43	59	90	829	2
44	59.5	47	45	59	90	838	2
46	62	47	47	58	90	906	2
48	64.5	50	49	57	90	998	2
50	67	48	51	57	90	1005	2
52	69.5	53	49	-	100	1270	2
53	71	54	49	-	100	1338	2
54	72	55	49	-	100	1351	2
55	73.5	53	52	-	100	1388	2
56	74.5	53	52	-	100	1389	2
57	76	53	52	-	100	1467	2
58	77	53	52	-	100	1480	2
60	79.5	58	55	-	100	1626	2
63	83.5	58	55	-	100	1740	2
65	86	63	65	-	100	1939	2

6305M / 6305A 12-point Deep Sockets 12-kant Steckschlüssel,lang Douilles longues, 12-pans



6300A 6305A (inch)	D ₁ (mm)	D ₂ (mm)	H ₁ (mm)	H ₂ (mm)	L (mm)	 (g)	 (pcs.)
3/4	28.5	34	20	64	90	292	5
25/32	29.5	34	21	64	90	334	5
13/16	31	34	22	64	90	343	5
7/8	32	34	23	64	90	347	5
15/16	34.5	34	25	64	90	352	5
1	37	34	27	64	90	384	5
1. 1/16	38.5	37	28	64	90	425	5
1. 1/8	41	38	30	63	90	503	5
1. 3/16	42	38	31	63	90	503	5
1. 1/4	44.5	40	34	62	90	544	5
1. 5/16	46	40	34	62	90	557	5
1. 3/8	48.5	42	36	61	90	622	5
1. 7/16	51	42	38	61	90	656	2
1. 1/2	52	45	39	60	90	710	2
1. 9/16	54.5	45	41	60	90	742	2
1. 5/8	56	47	42	59	90	802	2
1.11/16	58.5	47	44	59	90	831	2
1. 3/4	59.5	47	45	59	90	838	2
1.13/16	62	47	47	58	90	906	2
2	68.5	52	52	57	90	1061	2
2. 1/16	71	54	49	-	100	1338	2
2. 1/8	72	55	49	-	100	1351	2
2. 3/16	74.5	53	52	-	100	1389	2
2. 1/4	76	53	52	-	100	1467	2
2. 5/16	78.5	53	52	-	100	1787	2
2. 3/8	79.5	58	55	-	100	1626	2
2. 7/16	82	58	55	-	100	1715	2

6012M-75 (mm)	D (mm)	H ₁ (mm)	H ₂ (mm)	L (mm)	 (g)	 (pcs.)
12	35	15.5	40	75	253	10
14	35	15.5	40	75	265	10
15	35	15.5	40	75	271	10
16	35	15.5	40	75	285	10
17	35	15.5	40	75	292	10
18	35	15.5	40	75	302	10
19	35	15.5	40	75	312	10
20	35	15.5	40	75	323	10
21	38	15.5	40	75	330	10
22	38	22.5	40	75	340	10
24	38	22.5	40	75	362	10
27	38	22.5	40	75	402	10
30	38	28.5	40	75	445	10
32	38	28.5	40	75	485	10
36	42	28.5	40	75	663	10

6012M-75 Inhex Sockets Steckschlüssel für Innensechskant-Schrauben Douilles tournevis pour vis 6-pans creux

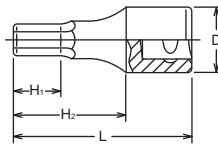

6101 Socket for Slotted Heads Steckschlüssel für Schlitzschrauben Douilles tournevis pour vis à fente

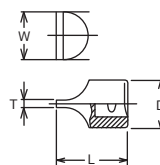

	TxW (mm)	D (mm)	L (mm)	 (g)	 (pcs.)
6101	6.4x33.5	35	50	205	5

Z-SERIES
HAND
TITANIUM
SCREWDRIVERS ACCESSORIES
IMPACT
SLEEVE-DRIVE
PROTECTOR
INDUSTRIAL
AUTOMOTIVE
MOTORCYCLE
CONSTRUCTION
SPARE PART

6749
6749-1000 ⚠️
6749-HEAD
PIPE-400 / -800

Reversible Ratchet
Knarre, verstellbar
Cliquet, réversible

SODH-System Two-Step Dog 36
* Renewal Kits → 6749RK → P318
RATCHET HANDLE

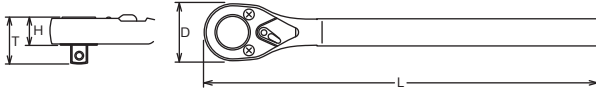

	D (mm)	T (mm)	H (mm)	L (mm)	(g)	(pce.)
6749	68	49.6	29.6	565	2840	1
6749-1000	68	49.6	29.6	965	3960	1
6749-HEAD	68	49.6	29.6	165	1730	1
PIPE-400	-	-	-	400	1110	1
PIPE-800	-	-	-	800	2230	1

⚠️ 6749-1000 has longer handle than standard, and can be loaded to excessive torque value. In the interest of your own safety always apply load evenly and progressively to avoid breakage and possible injury.

Der Gelenkgriff 6749-1000 ist länger als die Standardversion. Aus Gründen Ihrer Sicherheit, sollten dies Werkzeug nie ruckartig sondern nach und nach belastet werden, um Bruch und damit verbundene, mögliche Verletzungen zu vermeiden.

Dû au fait que la manche de la 6749-1000 est plus longue que le standard, il y a risque d'une surcharge excessive lors du serrage. Pour éviter casse et blessure, veuillez serrer d'une façon régulière et progressive.

6752
6752-HEAD
PIPE-400

Reversible Ratchet
Knarre, verstellbar
Cliquet, réversible

60
* Renewal Kits → 6752RK → P319

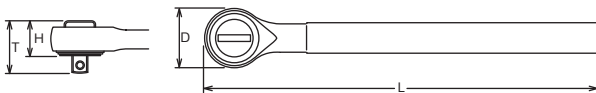

	D (mm)	T (mm)	H (mm)	L (mm)	(g)	(pce.)
6752	67	55.5	35.5	500	2360	1
6752-HEAD	67	55.5	35.5	100	1250	1
PIPE-400	-	-	-	400	1110	1

60

* Renewal Kits → **6755RK** → **P319**

	D (mm)	L (mm)	(g)	(pce.)
6755	62	97	1162	1

6755 Ratchet Adaptor
Aufsteckknarre
Cliquet adaptable

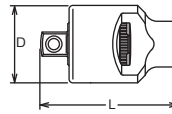

6760 Extension Bars
Verlängerungen
Rallonges

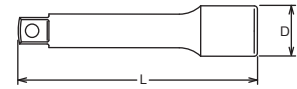

	D (mm)	L (mm)	(g)	(pce.)
6760-75	35	75	335	5
6760-100	35	100	434	2
6760-125	35	125	528	2
6760-150	35	150	624	2
6760-200	35	200	815	1
6760-300	35	300	1203	1
6760-400	35	400	1585	1

6768 Hinge Handle
Gelenkgriff
Poignée articulée



* Renewal Kits → **6768RK** → **P321**

	D (mm)	L (mm)	(g)	(pce.)
6768	42	450	1715	1

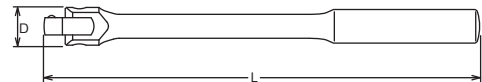

6768-600 / -1000 ⚠ Hinge Handle
6768-HEAD Gelenkgriff
PIPE-400 / -800 Poignée articulée



* Renewal Kits → **6768RK** → **P321**

	D (mm)	L (mm)	(g)	(pce.)
6768				
6768-600	42	600	2360	1
6768-1000	42	1000	3480	1
6768-HEAD	42	200	1250	1
PIPE-400	-	400	1110	1
PIPE-800	-	800	2230	1



⚠ 6768-600/-1000 have longer handle than standard, and can be loaded to excessive torque value. In the interest of your own safety always apply load evenly and progressively to avoid breakage and possible injury.

Der Art. 6768-600/-1000 hat einen längeren Griff als die Standardausführung und kann mit einem zu hohen Drehmoment belastet werden. Bitte vorsichtig verwenden.

Dù au fait que les manches des 6768-600 et 6768-1000 sont plus longues que le standard, il y a risque d'une surcharge excessive lors du serrage. Pour éviter casse et blessure, veuillez serrer d'une façon régulière et progressive.



Z-SERIES
HAND
TITANIUM
SCREWDRIVERS ACCESSORIES
IMPACT
SLEEVE-DRIVE
PROTECTOR
INDUSTRIAL
AUTOMOTIVE
MOTORCYCLE
CONSTRUCTION
SPARE PART

6785 T-Handle
T-Griff
Poignée coulissante

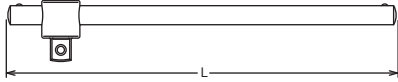
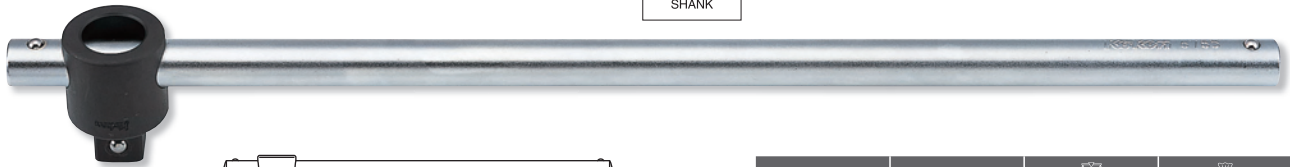

	L (mm)	⚖ (g)	📦 (pcs.)
6785	500	1542	1

6788 L-Handle
L-Griff
Poignée en L

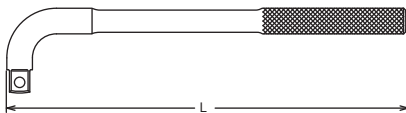

	L (mm)	⚖ (g)	📦 (pcs.)
6788	330	1175	1

6770 Universal Joint
Gelenk-Einsatz
Cardan universel

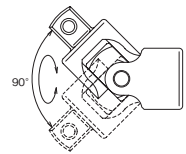
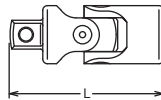

	L (mm)	⚖ (g)	📦 (pcs.)
6770	105	478	2

6644A Adaptor
Verbindungsstück
Réducteur

Warranty 668Nm
Garantie 668Nm
Garantie 668Nm

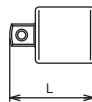

	⏏ (sq.)	⏏ (sq.)	L (mm)	⚖ (g)	📦 (pcs.)
6644A	3/4"	1/2"	47	136	5
6688A	3/4"	1"	60	285	5

⚠ Adapting down from bigger square drive to smaller square drive may lead to excessive torque load and possibly cause breakage. Always stay within safe torque of the smaller square drive.

Die mit ⚠ gekennzeichneten Artikel können bei Überbelastung zu Bruch gehen. Aus Gründen Ihrer eigenen Sicherheit sollten die betreffenden Werkzeuge nie ruckartig, sondern nach und nach belastet werden, um Bruch und damit verbundene mögliche Verletzungen zu vermeiden.

Il est possible d'appliquer aux articles marqués ⚠ des couples de serrage susceptibles d'occasionner leur rupture. Pour votre propre sécurité, veuillez toujours appliquer la charge d'une manière uniforme et progressive. Ceci pour éviter ruptures et accidents.

6688A Adaptor
Verbindungsstück
Augmentateur

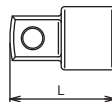

3/4"

Hand Sockets
Hand Steckschlüssel
Douilles à main

6201M-00 Socket Sets
6201A-00 Steckschlüssel Sätze
6201M-05 Jeux de clés à douilles
6201A-05



6201A-00	18 Pieces Set/△=17,600g
6201A-05	18 Pieces Set/△=17,600g
METAL CASE:W580xH200xT85mm	
Sockets	Accessories
(6201A-00) 6400A 6-pt. Sockets 7/8, 15/16, 1.1/16, 1.1/8, 1.1/4, 1.5/16, 1.7/16, 1.1/2, 1.5/8, 1.11/16, 1.13/16, 1.7/8, 2	6749 6760-200 6760-400 6768
(6201A-05) 6405A 12-pt. Sockets 7/8, 15/16, 1.1/16, 1.1/8, 1.1/4, 1.5/16, 1.7/16, 1.1/2, 1.5/8, 1.11/16, 1.13/16, 1.7/8, 2	6785

6201M-00	16 Pieces Set/△=17,300g
6201M-05	16 Pieces Set/△=17,300g
METAL CASE:W580xH200xT85mm	
Sockets	Accessories
(6201M-00) 6400M 6-pt. Sockets 22, 24, 27, 30, 32, 36, 41, 46, 50, 55, 60	6749 6760-200 6760-400 6768
(6201M-05) 6405M 12-pt. Sockets 22, 24, 27, 30, 32, 36, 41, 46, 50, 55, 60	6785

6212M-00 Socket Sets
6212M-05 Steckschlüssel Sätze
Jeux de clés à douilles



6212M-00	12 Pieces Set/△=8,200g
6212M-05	12 Pieces Set/△=8,200g
METAL CASE:W580xH124xT70mm	
Sockets	Accessories
(6212M-00) 6400M 6-pt. Sockets 22, 24, 27, 30, 32, 36, 41, 46, 50	6749 6760-200 6785
(6212M-05) 6405M 12-pt. Sockets 22, 24, 27, 30, 32, 36, 41, 46, 50	

Hand Sockets
Hand Steckschlüssel 1”
Douilles à main

Z-SERIES
HAND
TITANIUM
SCREWDRIVERS ACCESSORIES
IMPACT
SLEEVE-DRIVE
PROTECTOR
INDUSTRIAL
AUTOMOTIVE
MOTORCYCLE
CONSTRUCTION
SPARE PART

8400M / 8400A

6-point Sockets
6-kant Steckschlüssel
Douilles 6-pans

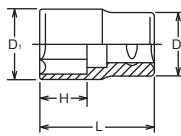

8405M / 8405A

12-point Sockets
12-kant Steckschlüssel
Douilles 12-pans

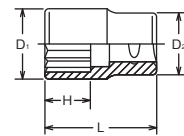

8400M 8405M (mm)	D ₁ (mm)	D ₂ (mm)	H (mm)	L (mm)	(g)	(pce.)
24	36.5	44	17	60	348	1
27	40.5	44	19	60	362	1
28	41.5	44	19.5	60	368	1
29	43	44	20	60	378	1
30	44	45	21	65	410	1
32	46.5	45	23	65	455	1
33	48	46	23.5	65	485	1
34	49	46	24	65	500	1
35	50.5	48	24.5	65	536	1
36	51.5	48	25	65	600	1
38	54	50	26	65	624	1
40	56.5	53	27	65	686	1
41	58	53	28	68	747	1
42	59	53	28.5	68	789	1
46	64	53	31	72	928	1
50	69	53	34	72	943	1
54	74	55	37	72	1016	1
55	75.5	53	42	77	1167	1
56	76.5	53	42	77	1160	1
58	79	53	41	77	1200	1
60	81.5	58	46	82	1440	1
63	85.5	58	45	82	1470	1
64	86.5	58	46	82	1540	1
65	88	63	49	86	1683	1
67	90.5	63	49	86	1840	1
68	91.5	63	49	86	1800	1
70	94	68	50	88	1963	1
71	95.5	68	50	88	2200	1
75	100.5	73	53	90	2204	1
78	104	75	52.5	90	2500	1
80	106.5	75	58	95	2550	1
83	110.5	78	57	95	2730	1
85	113	80	57	95	2680	1
90	119	80	59	100	3420	1
95	125.5	85	58	100	4900	1
100	131.5	85	57	100	4840	1

8400A 8405A (inch)	D ₁ (mm)	D ₂ (mm)	H (mm)	L (mm)	(g)	(pce.)
15/16	36.5	44	17	60	355	1
1. 3/16	44	45	21	65	410	1
1. 1/4	46.5	45	23	65	455	1
1. 5/16	48	46	23.5	65	485	1
1. 3/8	50.5	48	24.5	65	536	1
1. 7/16	53	50	25.5	65	607	1
1. 1/2	54	50	26	65	624	1
1. 9/16	56.5	53	27	65	686	1
1. 5/8	58	53	28	68	747	1
1.11/16	60.5	53	29	68	830	1
1. 3/4	61.5	53	29.5	68	807	1
1.13/16	64	53	31	72	928	1
1. 7/8	66.5	53	32	72	936	1
1.15/16	68	53	32.5	72	941	1
2	70.5	53	37	72	976	1
2. 1/16	73	54	37	72	1027	1
2. 1/8	74	55	37	72	1016	1
2. 3/16	76.5	53	41	77	1192	1
2. 1/4	78	53	41	77	1177	1
2. 5/16	80.5	53	41	77	1292	1
2. 3/8	81.5	58	46	82	1440	1
2. 7/16	84	58	45	82	1495	1
2. 1/2	86.5	58	45	82	1497	1
2. 9/16	88	63	49	86	1683	1
2. 5/8	90.5	63	49	86	1840	1
2.11/16	91.5	63	49	86	1800	1
2. 3/4	94	68	50	88	1963	1
2.13/16	96.5	68	50	88	2035	1
2. 7/8	98	70	50	88	2100	1
2.15/16	100.5	73	53	90	2204	1
3	103	75	53	90	2406	1
3. 1/8	106.5	75	58	95	2550	1
3. 1/4	110.5	78	57	95	2730	1
3. 3/8	114	80	57	95	3050	1
3. 1/2	119	80	59	100	3420	1
3. 3/4	125.5	85	58	100	4900	1

8012M-80 (mm)	D (mm)	H ₁ (mm)	H ₂ (mm)	L (mm)	(g)	(pcs.)
17	44.2	15.5	45	80	400	5
19	44.2	15.5	45	80	410	5
22	47.9	22.5	45	80	436	5
24	47.9	22.5	45	80	471	5
27	47.9	22.5	45	80	526	5
30	47.9	22.5	45	80	658	5
32	47.9	22.5	45	80	715	5
36	54.2	22.5	45	80	945	5

8012M-80

Inhex Sockets
Steckschlüssel für Innensechskant-Schrauben
Douilles tournevis pour vis 6-pans creux

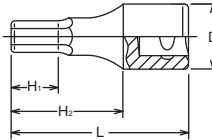

	D (mm)	L (mm)	(g)	(pce.)
8760-200	44	200	1300	1
8760-400	44	400	2570	1

8760

Extension Bars
Verlängerungen
Rallonges

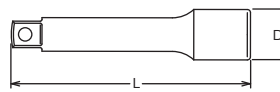

	L (mm)	(g)	(pce.)
8770	143	1170	1

8770

Universal Joint
Gelenk-Einsatz
Cardan universel

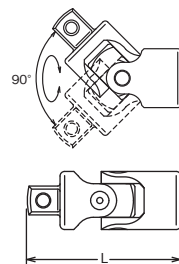

	(sq.)	(sq.)	L (mm)	(g)	(pcs.)
8866A	1"	3/4"	60	338	5

⚠ Adapting down from bigger square drive to smaller square drive may lead to excessive torque and possibly cause breakage.

Reduzierstücke sind mit Vernunft einzusetzen.
Es besteht Bruchgefahr. Überschreiten Sie niemals die Sicherheitsgrenzen.

Les réducteurs doivent être utilisés avec modération. Ne dépassez jamais les limites de sécurité.

8866A

Adaptor
Verbindungsstück
Réducteur

Warranty 1850Nm
Garantie 1850Nm
Garantie 1850Nm **⚠**

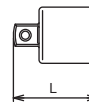

Z-SERIES
HAND
TITANIUM
ACCESSORIES
SCREWDRIVERS
IMPACT
SLEEVE-DRIVE
PROTECTOR
INDUSTRIAL
AUTOMOTIVE
MOTORCYCLE
CONSTRUCTION
SPARE PART

8749
8749-1000 ⚠️
8749-HEAD
PIPE-580 / -800

Reversible Ratchet
Knarre, verstellbar
Cliquet, réversible



* Renewal Kits → 8749RK → P318

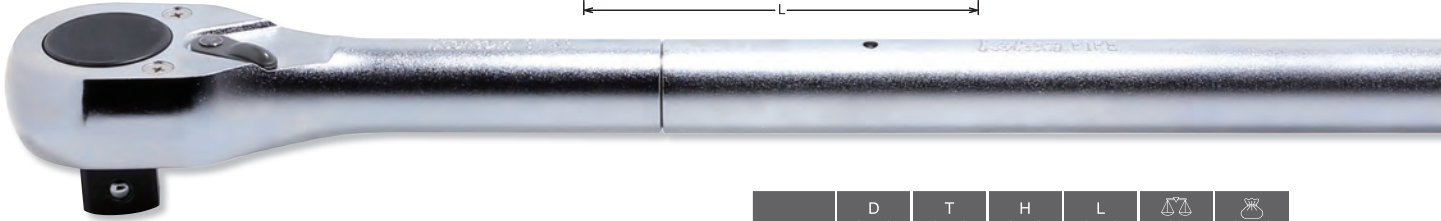
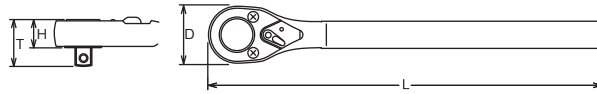

⚠️ 8749-1000 has longer handle than standard, and can be loaded to excessive torque value. In the interest of your own safety always apply load evenly and progressively to avoid breakage and possible injury.

Der Art. 8749-1000 hat einen längeren Griff als die Standardausführung und kann mit einem zu hohen Drehmoment belastet werden. Bitte vorsichtig verwenden.

Dû au fait que la manche de la 8749-1000 est plus longue que le standard, il y a risque d'une surcharge excessive lors du serrage. Pour éviter casse et blessure, veuillez serrer d'une façon régulière et progressive.

	D (mm)	T (mm)	H (mm)	L (mm)	(g)	(pce.)
8749	70	62.2	36.2	800	4100	1
8749-1000	70	62.2	36.2	1020	4720	1
8749-HEAD	70	62.2	36.2	220	2490	1
PIPE-580	-	-	-	580	1610	1
PIPE-800	-	-	-	800	2230	1

8768
8768-1000 ⚠️
8768-HEAD
PIPE-400 / -800

Hinge Handle
Gelenkgriff
Poignée articulée

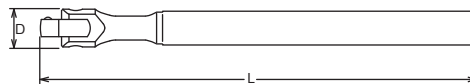

⚠️ 8768-1000 has longer handle than standard, and can be loaded to excessive torque value. In the interest of your own safety always apply load evenly and progressively to avoid breakage and possible injury.

Der Art. 8768-1000 hat einen längeren Griff als die Standardausführung und kann mit einem zu hohen Drehmoment belastet werden. Bitte vorsichtig verwenden.

Dû au fait que la manche de la 8768-1000 est plus longue que le standard, il y a risque d'une surcharge excessive lors du serrage. Pour éviter casse et blessure, veuillez serrer d'une façon régulière et progressive.

* Renewal Kits → 8768RK → P321

	D (mm)	L (mm)	(g)	(pce.)
8768	55	600	2590	1
8768-1000	55	1000	3710	1
8768-HEAD	55	200	1480	1
PIPE-400	-	400	1110	1
PIPE-800	-	800	2230	1

8785
8785-700

T-Handle
T-Griff
Poignée coulissante



	L (mm)	(g)	(pce.)
8785	550	3190	1
8785-700	700	3906	1

8788
L-Handle
L-Griff
Poignée en L

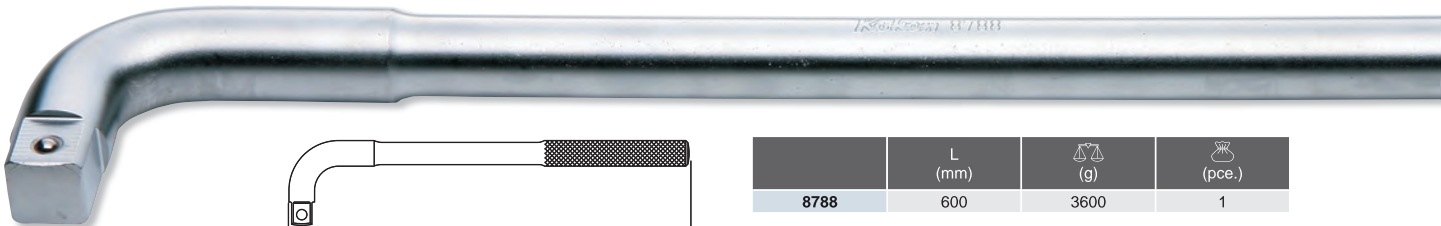
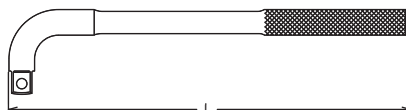

	L (mm)	(g)	(pce.)
8788	600	3600	1

1”

Hand Sockets
Hand Steckschlüssel
Douilles à main

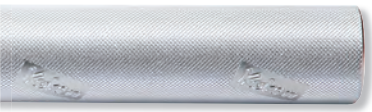
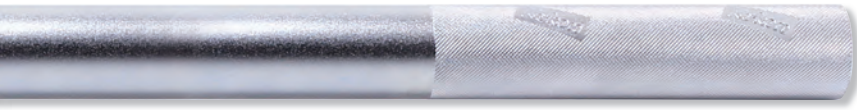

Z-SERIES
HAND
TITANIUM
ACCESSORIES
SCREWDRIVERS
IMPACT
SLEEVE-DRIVE
PROTECTOR
INDUSTRIAL
AUTOMOTIVE
MOTORCYCLE
CONSTRUCTION
SPARE PART



Hand Sockets
Hand Steckschlüssel 1"
Douilles à main

8225M-00 Socket Sets
Steckschlüssel Sätze
8225M-05 Jeux de clés à douilles



8225M-00 15 Pieces Set/重量=27,000g
8225M-05 15 Pieces Set/重量=27,000g

METAL CASE:W600xH217xT97mm

Sockets	Accessories
(8225M-00) 8400M 6-pt. Sockets 32, 33, 36, 41, 46, 50, 55, 60, 65, 70, 75, 80	 8749
(8225M-05) 8405M 12-pt. Sockets 32, 33, 36, 41, 46, 50, 55, 60, 65, 70, 75, 80	 8760-200  8760-400



Z-SERIES
HAND
TITANIUM
ACCESSORIES
SCREWDRIVERS
IMPACT
SLEEVE-DRIVE
PROTECTOR
INDUSTRIAL
AUTOMOTIVE
MOTORCYCLE
CONSTRUCTION
SPARE PART



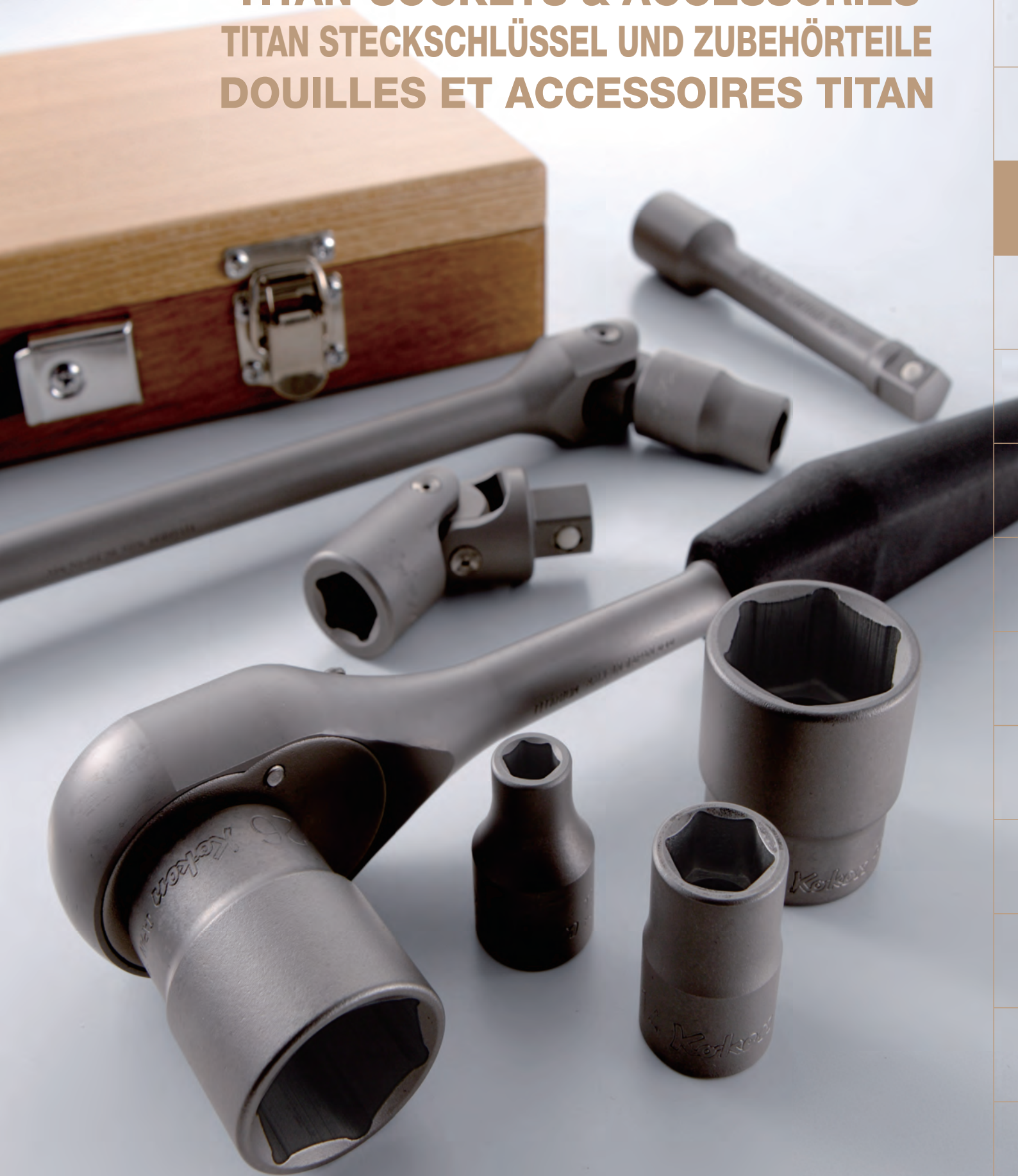

TITAN-SOCKETS & ACCESSORIES
TITAN STECKSCHLÜSSEL UND ZUBEHÖRTEILE
DOUILLES ET ACCESSOIRES TITAN

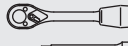

Z-SERIES
HAND
TITANIUM
SCREWDRIVERS ACCESSORIES
IMPACT
SLEEVE-DRIVE
PROTECTOR
INDUSTRIAL
AUTOMOTIVE
MOTORCYCLE
CONSTRUCTION
SPARE PART

TI4261M Socket Set Titanium
Steckschlüssel Satz Titanium
Jeu de clés à douille Titanium



TI4261M		18 Pieces Set/△=4,280g	
WOODEN CASE:W445xH190xT60mm			
Sockets		Accessories	
	TI4400M 6-pt. Sockets 8, 10, 11, 12, 13, 14, 17, 19, 21, 22, 24, 26, 27		TI4749J
			TI4760-125
			TI4760-250
			TI4768J-380
			TI4770

Characteristic of TITAN

- Light weight : Makes it effective for operating tools. The specific gravity is only about 58% of chrome molybdenum steel which is used for our normal products.
- Non-Corrosion : Corrosion Resistance is greatly improved against salt water and any kind of chemical products.
- Non-Magnetic : Non-Magnetic material will prevent the tools from magnetizing.

Eigenschaften der TITAN Legierung

- Geringes Gewicht : Das spezifische Gewicht liegt bei 58% herkömmlicher Chrom-Molybdän Stähle.
- Korrosionsfest : Meerwasser oder Säuren hinterlassen keine Spuren.
- Nicht magnetisch : Titan Werkzeuge lassen sich nicht magnetisieren.

Caractéristiques de l'alliage TITAN

- Légèreté : Son poids spécifique n'est que 58% de celui de l'acier au chrome-molybdène utilisé pour tous nos produits standards.
- Anti-corrosion : Aussi bien pour l'eau que pour tous les produits chimiques.
- Anti-magnétique : Le Titan empêche toute magnétisation de l'outil.



Pentagonal drive is designed to avoid using with normal square drive items, so that it will provide extra safety and much more strength.

Der 5-kant Antrieb (Pentagon-Drive) gewährt einen kraftvollen Anzug und unterbindet aus Sicherheitsgründen die Verwendung von Zubehörteilen anderer Legierungen.

L'entraînement pentagonal est conçu pour obtenir un serrage puissant et pour empêcher l'utilisation d'accessoires traditionnels et ce pour des raisons de sécurité.



**ACCESSORIES
ZUBEHÖRTEILE
ACCESSOIRES**



Stud Pullers & Setters
 Stehbolzendreher
 Extracteurs de goujons

Z-SERIES
 HAND
 TITANIUM
 ACCESSORIES
 SCREWDRIVERS
 IMPACT
 SLEEVE-DRIVE
 PROTECTOR
 INDUSTRIAL
 AUTOMOTIVE
 MOTORCYCLE
 CONSTRUCTION
 SPARE PART

4100M / 4100A Stud Pullers
 Stehbolzendreher
 Extracteurs de goujons

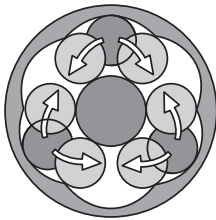
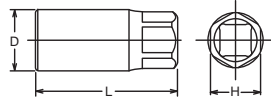

Stud Pullers
 Hexagon body design can lessen the excessive load on cages and rollers inside the pullers.

Stehbolzendreher
 Der neue Körper mit sechs Walzenmulden verteilt den Druck auf Käfig und Walzen weitaus vorteilhafter.

Extracteurs de goujons
 Le nouveau corps de forme hexagonale répartit l'effort de façon plus uniforme sur la cage et les rouleaux.

4100M (mm)		D (mm)	L (mm)	H (mm)	(g)	(pcs.)	
5	1/2"	24	65	21	145	10	
6		24	65	21	150	10	
7		24	65	21	150	10	
8		24	65	21	147	10	
9		28	75	21	217	10	
10		28	75	21	213	10	
10.5		28	75	21	202	10	
11		28	75	21	218	10	
12		28	75	21	220	10	
14		34	75	27	340	5	
16		-⚠	34	75	27	315	5

4100A (inch)		D (mm)	L (mm)	H (mm)	(g)	(pcs.)
1/4	1/2"	24	65	21	150	10
5/16		24	65	21	147	10
3/8		28	75	21	213	10
7/16		28	75	21	218	10
1/2		28	75	21	191	10
9/16		34	75	27	340	5
5/8	-⚠	34	75	27	315	5

* Renewal Kits → **4100MRK/4100ARK** → P321
 ⚠ 4100M-16 and 4100A-5/8 do not have 1/2" square drive.
 Drive the outer hexagon part with 27mm sockets or ring wrenches.
 Die Artikel 4100M 16mm und 4100A 5/8" haben keinen 1/2" Antriebsvierkant.
 Bitte benutzen Sie den 27mm Aussensechskant.
 Les articles 4100M-16 et 4100A-5/8" n'ont pas de carré entraînant 1/2" , veuillez utiliser l'hexagonal 6 pans 27 mm

Tolerance			
4100M (mm)		4100A (inch)	
5	4.7- 5	1/4	6 - 6.4
6	5.6- 6	5/16	7.6- 8
7	6.6- 7	3/8	9 - 9.6
8	7.6- 8	7/16	10.5-11.1
9	8.4- 9	1/2	12.1-12.7
10	9.4-10	9/16	13.5-14.3
10.5	9.9-10.5	5/8	15.2-16
11	10.4-11		
12	11.4-12		
14	13.2-14		
16	15.2-16		

4211M / 4211A Stud Pullers Sets
 Stehbolzendreher im Satz
 Jeux d'extracteurs de goujons



4211M 4 Pieces Set/△=1,040g
 METAL CASE:W215xH80xT47mm
 PULLER
 ○ 4100M Stud Pullers
 6, 8, 10, 12

4211A 4 Pieces Set/△=1,040g
 METAL CASE:W215xH80xT47mm
 PULLER
 ○ 4100A Stud Pullers
 1/4, 5/16, 3/8, 1/2

4214M Stud Pullers Set
 Stehbolzendreher im Satz
 Jeux d'extracteurs de goujons



4214M 5 Pieces Set/△=1,450g
 METAL CASE:W215xH80xT47mm
 PULLER
 ○ 4100M Stud Pullers
 6, 8, 10, 12, 14

6100M (mm)		D (mm)	L (mm)	H (mm)	(g)	(pcs.)
18	3/4"	48	100	36	840	1
20		48	100	36	816	1
22		48	100	36	745	1
24		48	100	36	739	1
27		63	125	46	1707	1
28		63	125	46	1701	1
29		63	125	46	1696	1
30		63	125	46	1691	1

* Renewal Kits → 6100MRK → P321

6100M-22 to -30 do not have 3/4" square drive.
Drive the outer hexagon part with sockets or ring wrenches
(size 22-24mm = 36H, 27-30mm = 46H.)

Die Stehbolzendreher ab Abmessung 22mm haben keinen 3/4" Antriebsvierkant.
Bitte benutzen sie den Aussensechskant.

Les extracteurs de goujon à partir de la dimension 22mm n'ont pas de carré d'entraînement 3/4".
Veuillez utiliser le carré extérieur.

Tolerance

6100M (mm)	Tolerance
18	16.9-18
20	18.8-20
22	20.8-22
24	22.7-24
27	25.7-27
28	26.7-28
29	27.6-29
30	28.6-30

6100M Stud Pullers
Stehbolzendreher
Extracteurs de goujons

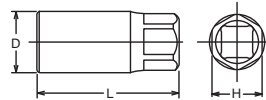

14100M (mm)		D ₁ (mm)	D ₂ (mm)	L (mm)	(g)	(pcs.)	
6	1/2"	24	25	48	126	10	*1
7		24	25	48	126	10	*1
8		24	25	48	122	10	*1
9		28	30	48	181	10	*2
10		28	30	48	181	10	*2
12		28	30	48	175	10	*2

14100A (inch)		D ₁ (mm)	D ₂ (mm)	L (mm)	(g)	(pcs.)	
1/4	1/2"	24	25	48	126	10	*1
5/16		24	25	48	122	10	*1
3/8		28	30	48	181	10	*2
7/16		28	30	48	181	10	*2
1/2		28	30	48	180	10	*2

*1 C-Ring=C41,Pin/O-Ring=A41/B41 → P268-269
*2 C-Ring=C42,Pin/O-Ring=A42/B42

Tolerance

14100M (mm)	Tolerance	14100A (inch)	Tolerance
6	5.6- 6	1/4	6 - 6.4
7	6.6- 7	5/16	7.6- 8
8	7.6- 8	3/8	9 - 9.6
9	8.4- 9	7/16	10.5-11.1
10	9.4-10	1/2	12.1-12.7
12	11.4-12		

14100M / 14100A IMPACT Stud Pullers
IMPACT Stehbolzendreher
Extracteurs de goujons IMPACT

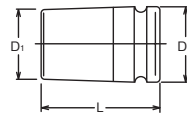

Stud Pullers & Setters
 Stehbolzendreher
 Extracteurs de goujons

Z-SERIES
 HAND
 TITANIUM
 ACCESSORIES
 SCREWDRIVERS
 IMPACT
 SLEEVE-DRIVE
 PROTECTOR
 INDUSTRIAL
 AUTOMOTIVE
 MOTORCYCLE
 CONSTRUCTION
 SPARE PART

4104 Stud Puller
 Stehbolzendreher
 Extracteur de goujons

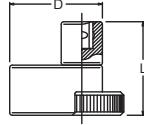

4104	□	Tolerance		D (mm)	L (mm)	⚖ (g)	📦 (pcs.)
		min	max				
	1/2"	φ 6	φ 19	54	56	489	2

4103M / 4103A Stud Bolt Setters
 Stehbolzensetzer
 Monte-goujons ⚠

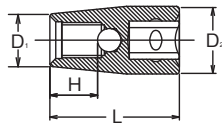

4103M (mm)	□	D ₁ (mm)	D ₂ (mm)	H (mm)	L (mm)	⚖ (g)	📦 (pcs.)
6(1.0)	1/2"	10.3	22	9	37	54	10
7(1.0)		11.5	22	10	37	58	10
8(1.25)		13.2	22	11	37	60	10
10(1.25)		15.3	23	13	44	86	10
10(1.5)		15.3	23	13	44	86	10
12(1.25)		17.8	23	14	44	86	10
12(1.75)	17.8	23	14	44	86	10	

4103A (inch)	□	D ₁ (mm)	D ₂ (mm)	H (mm)	L (mm)	⚖ (g)	📦 (pcs.)
New 1/4(28)	1/2"	10.7	22	9	37	55	10
New 5/16(18)		13.2	22	11	37	61	10
New 5/16(24)		13.2	22	11	37	61	10
New 3/8(16)		14.6	22.9	12	44	84	10
New 7/16(14)		16.5	22.9	14	44	85	10
New 1/2(13)		19	22.9	14	44	88	10

⚠ Depend on the stud bolt and using torque, 4103M/13103M/14103M may cause a scratch against the stud bolts or got stuck itself during a work.

4203M Stud Bolt Setters Set
 Stehbolzensetzer im Satz
4203MF Jeu de monte-goujons



4203M 4 Pieces Set/⚖=530g

METAL CASE:W130xH65xT26mm

Stud Bolt Setter

4103M Stud Bolt Setters
 6(1.0), 8(1.25), 10(1.5), 12(1.75)

4203MF 4 Pieces Set/⚖=530g

METAL CASE:W130xH65xT26mm

Stud Bolt Setter

4103M Stud Bolt Setters
 6(1.0), 8(1.25), 10(1.25), 12(1.25)

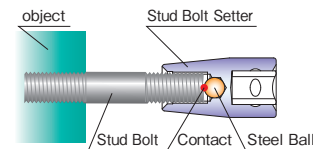

A special socket for installing a stud bolt. Inside steel ball prevents the stud bolt stuck onto the socket. After installing a stud bolt, turn to anti-clockwise to removing the socket.

Spezialwerkzeug zum Setzen von Stehbolzen. Der Bolzen trifft im Werkzeug nur auf die gehärtete Stahlkugel, was die Kontaktfläche verringert. Nach dem Setzen des Stehbolzens kann das Werkzeug im Linkslauf vom Stehbolzen abgezogen werden.

Doilles spéciales pour monter les goujons. Le goujon est en contact avec une bille d'acier pour l'empêcher d'adhérer à la douille. Après avoir posé le goujon, tourner dans le sens antihorlogique pour le retirer.

13103M (mm)		D ₁ (mm)	D ₂ (mm)	H (mm)	L (mm)			
5(0.8)	3/8"	9.5	19	8	32	39	10	*1
6(1.0)		10.8	19	9	32	41	10	*1
7(1.0)		12.5	19	10	32	44	10	*1
8(1.25)		13.5	19	11	35	49	10	*1
10(1.25)		15.8	19	13	35	49	10	*1
10(1.5)		15.8	19	13	35	49	10	*1

*1 C-Ring=C31, Pin/O-Ring=A31/B31 → P268-269

Depend on the stud bolt and using torque, 4103M/13103M/14103M may cause a scratch against the stud bolts or got stuck itself during a work.

14103M (mm)		D ₁ (mm)	D ₂ (mm)	H (mm)	L (mm)			
6(1.0)	1/2"	12	25	11	42	75	10	*1
7(1.0)		13.2	25	12	42	78	10	*1
8(1.25)		14.5	25	15	42	81	10	*1
10(1.25)		17	25	18	49	106	10	*1
10(1.5)		17	25	18	49	106	10	*1
12(1.25)		19.5	25	19	49	107	10	*1
12(1.75)		19.5	25	19	49	107	10	*1
14(1.5)		22	25	21	55	128	10	*1
14(2.0)	22	25	21	55	128	10	*1	

*1 C-Ring=C41, Pin/O-Ring=A41/B41 → P268-269

Depend on the stud bolt and using torque, 4103M/13103M/14103M may cause a scratch against the stud bolts or got stuck itself during a work.

23103M (mm)	D ₁ (mm)	D ₂ (mm)	H (mm)	L (mm)			
New 6(1.0)	11.1	22	9	59	175	10	*1
New 8(1.25)	13.6	22	11	61	181	10	*1
New 10(1.25)	16	22	13	63	188	10	*1
New 10(1.5)	16	22	13	63	188	10	*1

*1 C-Ring=C32, Pin/O-Ring=A32/B32 → P268-269

This item is not suitable for impact drivers.
Depend on the stud bolt and tightening torque, 23103M / 24103M may cause a scratch against the stud bolts or got stuck itself during a work.

24103M (mm)	D ₁ (mm)	D ₂ (mm)	H (mm)	L (mm)			
New 8(1.25)	15.4	30	15	69	332	10	*1
New 10(1.25)	17.8	30	18	72	344	10	*1
New 10(1.5)	17.8	30	18	72	344	10	*1
New 12(1.75)	20.2	30	19	74	352	10	*1

*1 C-Ring=C42, Pin/O-Ring=A42/B42 → P268-269

This item is not suitable for Impact Drivers.
The tool should only be used with non-impacting electric screwdrivers.

Das Werkzeug ist nicht für Schlagschrauber geeignet.
Das Werkzeug sollte ausschliesslich mit nicht schlagenden Elektroschraubern verwendet werden.

L'outil n'est pas adapté aux visseuses à chocs.
L'outil doit être utilisé exclusivement avec des visseuses électriques non percutantes.

13103M Impact Stud Bolt Setters Impact Stehbolzensetzer Monte-goujons Impact

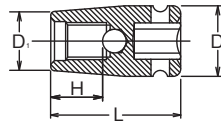

14103M Impact Stud Bolt Setters Impact Stehbolzensetzer Monte-goujons Impact

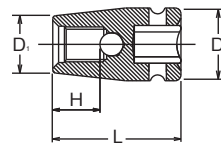

23103M Stud Bolt Setter with unlocking system Stehbolzensetzer mit Entriegelungssystem Monte-goujons avec système de déverrouillage

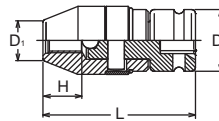

24103M Stud Bolt Setter with unlocking system Stehbolzensetzer mit Entriegelungssystem Monte-goujons avec système de déverrouillage

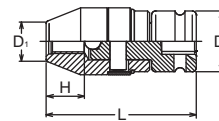

23103M/24103M -Stud Bolt Setter with unlocking system-

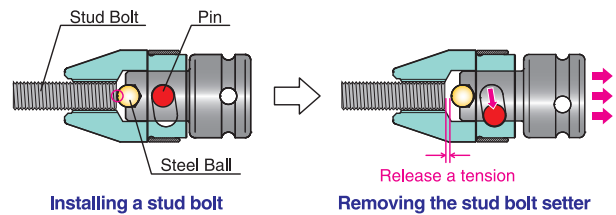

The stud setter has an unlocking system that allows the tool to be easily unscrewed from the stud.

Der Stehbolzensetzer verfügt über ein Entriegelungssystem dadurch lässt sich das Werkzeug ganz leicht vom Stehbolzen abtrennen.

L'outil de pose de goujons dispose d'un système de déverrouillage qui permet de le détacher facilement du goujon.

Tap Holder / Die Holder
 Halter für Gewindeschneider / Halter für Gewindeschneideisen
 Porte taraud / Porte-filière

Z-SERIES
 HAND
 TITANIUM
 ACCESSORIES
 SCREWDRIVERS
 IMPACT
 SLEEVE-DRIVE
 PROTECTOR
 INDUSTRIAL
 AUTOMOTIVE
 MOTORCYCLE
 CONSTRUCTION
 SPARE PART

3131E Tap Holder
 Halter für Gewindeschneider
 Porte taraud / porte-filière

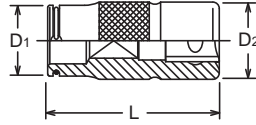

3131E	□	D ₁ (mm)	D ₂ (mm)	L (mm)	(g)	(pcs.)
□2.1x	□2.8	6.8	18	40	45	10
□2.7x	□3.5	8	18	40	46	10
□3.4x	□4.5	9.5	18	40	47	10
□4.9x	□6	11.5	18	40	48	10
□5.5x	□7	12.5	18	40	49	10
□7	□9	15	18	40	48	10
□9	□11	17	18	40	48	10
□9	□12	18	18	40	48	10

For DIN352, DIN351, DIN2181, DIN5157 tap

3264 Tap Holder set 10 pieces
 Halter für Gewindeschneider im Satz
 Jeu de portes taraud



3264 10 Pieces Set/ 1.050g

METAL CASE: W240xH100xT32mm

Sockets		Accessories	
3131E	□2.1x□2.8, □2.7x□3.5, □3.4x□4.5, □4.9x□6, □5.5x□7, □7x□9, □9x□11, □9x□12,		160K
			3760-125

3131A Adjustable Tap Holder
 Halter für Gewindeschneider, einstellbar
4131A Porte taraud, ajustable

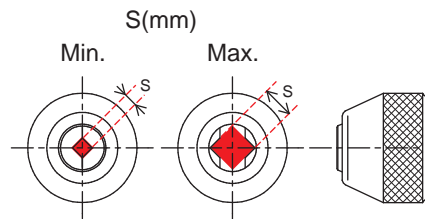
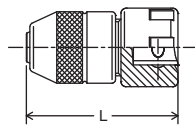

3131A	□	S(mm)		L (mm)	(g)	(pcs.)
		Min.	Max.			
1	□3/8"	2.0	5.0	42	80	5
2	□3/8"	4.5	8.0	47	100	5

4131A	□	S(mm)		L (mm)	(g)	(pcs.)
		Min.	Max.			
3	□1/2"	5.5	12	69	400	2

160K Reversible Ratchet
 Verstellbare Knarre
 Cliquet réversible

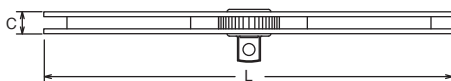

Tap is not included.
 Gewindeschneider, nicht enthalten.
 Taraud non inclus.

	□	C (mm)	L (mm)	(g)	(pce.)
160K	□3/8"	10	220	130	1
160K-1/2	□1/2"	10	220	135	1

3132 Die Holder
 Halter für Gewindeschneideisen
4132 Porte-filière

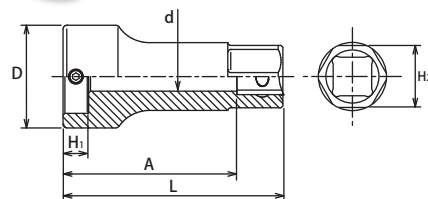

	□	D (mm)	H ₁ (mm)	H ₂ (mm)	d (mm)	A (mm)	L (mm)	(g)	(pcs.)
3132-20	□3/8"	28	7	17	8	45	60	130	5
4132-25		34	9	22	14	40	60	170	2
4132-38	□1/2"	48	13	24	18	60	80	315	2
4132-50		60	16	27	30	85	105	740	2



Die is not included.
 Gewindeschneideisen, nicht enthalten.
 Filière non inclus.

2127 (mm)		D ₁ (mm)	D ₂ (mm)	H (mm)	L (mm)	(g)	(pcs.)
4	1/4"	7	13	4	23	14	10
4.5		7.4	13	4	23	14	10
5		8	13	5	23	14	10
5.5		8.8	13	5	23	14	10
6		9.5	13	6	23	14	10
7		10.9	13	6	23	14	10
8		11.5	13	8	23	14	10
9		13	13	8	23	15	10
9.5		13.8	13	10	23	16	10
10		14.8	13	10	23	17	10



2127 NUTTWISTER®

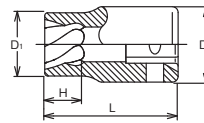

RS2127/6	6 Pieces Set/Rail 150mm	(g)
4, 4.5, 5, 5.5, 6, 7		105

RS2127/6 Socket Set on Rail
Steckschlüsselsatz auf Schiene
Jeu de douilles sur rail



RS2127/10	10 Pieces Set/Rail 150mm	(g)
4, 4.5, 5, 5.5, 6, 7, 8, 9, 9.5, 10		180

RS2127/10 Socket Set on Rail
Steckschlüsselsatz auf Schiene
Jeu de douilles sur rail



3127 (mm)		D ₁ (mm)	D ₂ (mm)	H (mm)	L (mm)	(g)	(pcs.)
8	3/8"	11.5	19	8	32	40	10
9		13	19	8	32	40	10
9.5		13.8	19	8	32	41	10
10		14.8	19	10	32	41	10
11		16	19	10	32	43	10
12		17	19	12	32	44	10
13		18.5	19	12	32	46	10
14		19.7	19	14	32	48	10
15		20.7	19	14	32	52	10
16		22.2	22	14	32	66	10
17	23.5	22	16	35	80	10	
19	26	22	16	35	92	10	

3127 NUTTWISTER®

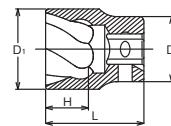

RS3127/8	8 Pieces Set/Rail 200mm	(g)
8, 9, 10, 11, 12, 13, 14, 16		420

RS3127/8 Socket Set on Rail
Steckschlüsselsatz auf Schiene
Jeu de douilles sur rail



3128-80 (mm)		D ₁ (mm)	D ₂ (mm)	H (mm)	L (mm)	(g)	(pcs.)
8	3/8"	11.5	19	6	80	58	10
9		13	19	6	80	61	10
10		14.8	19	8	80	66	10
11		16	19	8	80	70	10
12		17	19	10	80	77	10
13		18.5	19	10	80	80	10
14		19.7	19	12	80	82	10

3128 (L80) NUTTWISTER® (Long type)

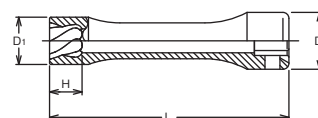

Z-SERIES
HAND
TITANIUM
ACCESSORIES
SCREWDRIVERS
IMPACT
SLEEVE-DRIVE
PROTECTOR
INDUSTRIAL
AUTOMOTIVE
MOTORCYCLE
CONSTRUCTION
SPARE PART

4127  NUTTWISTER®

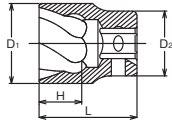

4127 (mm)		D ₁ (mm)	D ₂ (mm)	H (mm)	L (mm)	(g)	(pcs.)
14	1/2"	19.7	30	14	42	125	10
17		23.5	30	16	42	137	10
19		26	30	16	42	146	10
21		28	30	17	42	153	10
22		29.5	30	17	42	158	10
24		32	30	18	42	174	10
25.4		33.5	30	18	42	183	10

RS4127/6   Socket Set on Rail
Steckschlüsselsatz auf Schiene
Jeu de douilles sur rail



RS4127/6	6 Pieces Set/Rail 200mm	(g)
	17, 19, 21, 22, 24, 25.4	960

4128 (L120)  NUTTWISTER® (Long type)

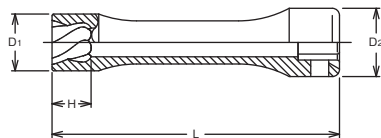

4128-120 (mm)		D ₁ (mm)	D ₂ (mm)	H (mm)	L (mm)	(g)	(pcs.)
17	1/2"	23.5	30	16	120	227	10
19		26	30	16	120	247	10
21		28	30	17	120	262	10
22		29.5	30	17	120	259	10

A very effective method and easy solution for removing rounded off nuts, bolts and studs. The sharp edges of the NUTTWISTER® Socket opening will tighten around the nut, bolt or stud and turn it easily off.

Eine einfache und wirkungsvolle Methode rund gedrehte Muttern und Bolzen herausdrehen bzw. zu öffnen.
Die scharfen Kanten der gewundenen NUTTWISTER® Öffnung setzen sich um die Mutter bzw. den Schraubenkopf und drehen sie problemlos heraus.

Il existe une méthode simple mais efficace pour retirer les écrous et les boulons arrondis ainsi que les goujons et les dispositifs de verrouillage des jantes.
Les arêtes vives de la douille NUTTWISTER® vont «mordre» l'écrou, le boulon ou le goujon et permettre ainsi facilement son extraction.



3129-32 (mm)		D ₁ (mm)	D ₂ (mm)	L (mm)	(g)	(pcs.)
2	3/8"	2	19	32	32	10
3		3	19	32	33	10
4		4	19	32	33	10
6		6	19	32	35	10
8		8	19	32	37	10
10		10	19	32	40	10

3129-60 (mm)		D ₁ (mm)	D ₂ (mm)	L (mm)	(g)	(pcs.)
2	3/8"	2	19	60	38	10
3		3	19	60	42	10
4		4	19	60	44	10
6		6	19	60	47	10
8		8	19	60	53	10
10		10	19	60	64	10

RS3129/6-L32	6 Pieces Set/Rail 150mm	(g)
2, 3, 4, 6, 8, 10		250

RS3129/6-L60	6 Pieces Set/Rail 150mm	(g)
2, 3, 4, 6, 8, 10		320

4129-37 (mm)		D ₁ (mm)	D ₂ (mm)	L (mm)	(g)	(pcs.)
8	1/2"	8	24	37	59	10
10		10	24	37	63	10
12		12	24	37	67	10
14		14	24	37	72	10
16		16	24	37	78	10

4129-75 (mm)		D ₁ (mm)	D ₂ (mm)	L (mm)	(g)	(pcs.)
8	1/2"	8	24	75	80	10
10		10	24	75	94	10
12		12	24	75	110	10
14		14	24	75	130	10
16		16	24	75	150	10

RS4129/5-L37	5 Pieces Set/Rail 150mm	(g)
8, 10, 12, 14, 16		370

RS4129/5-L75	5 Pieces Set/Rail 150mm	(g)
8, 10, 12, 14, 16		600



3129-32 / -60 BOLTTWISTER®

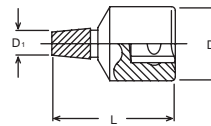

RS3129/6-L32 / -L60

Socket Set on Rail
Steckschlüsselsatz auf Schiene
Jeu de douilles sur rail



4129-37 / -75 BOLTTWISTER®

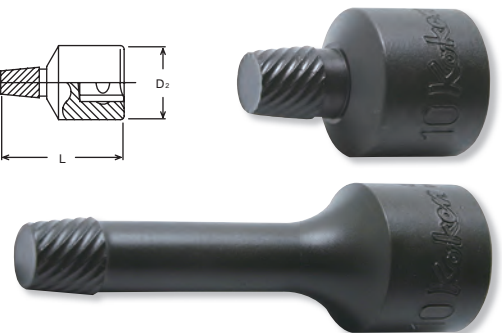
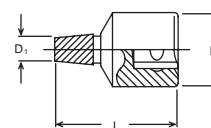

RS4129/5-L37 / -L75

Socket Set on Rail
Steckschlüsselsatz auf Schiene
Jeu de douilles sur rail

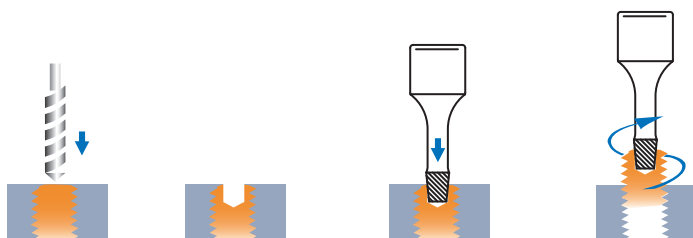

Effective method and easy solution for removing twisted of bolt. Drill a hole in the center of bolt and drive BOLTTWISTER® firmly into the hole. The sharp Spirals edges will hold the broken bolt and easily remove it.

Eine effektive Methode und einfache Lösung zum Entfernen von verdrehten Schrauben. Bohren Sie ein Loch in die Mitte der Schraube und treiben Sie den BOLTTWISTER fest in das Loch. Die scharfen Spiralkanten halten die gebrochene Schraube fest und entfernen diese leicht.

Une méthode efficace et une solution simple pour enlever les vis tordues. Percez un trou au centre de la vis et enfoncez fermement le BOLTTWISTER dans le trou. Les arêtes hélicoïdales tranchantes maintiennent la vis cassée et permettent de la retirer facilement.

BOLTTWISTER	Bolt size	Drill size
2	M5	φ 2.4 ~ 2.6
3	M6	φ 3.2 ~ 3.5
4	M8	φ 4.2 ~ 4.5
6	M10 ~ M12	φ 6.2 ~ 6.5
8	M14 ~ M16	φ 8.2 ~ 8.5
10	M18 ~ M20	φ 10.2 ~ 10.5
12	M22 ~ M24	φ 12.2 ~ 12.5
14	M27 ~ M30	φ 14.2 ~ 14.5
16	M33	φ 16.2 ~ 16.5

Ratcheting Ring Spanners

Knarren-Ringschlüssel

Clés hexagonales à cliquet

Z-SERIES
HAND
TITANIUM
ACCESSORIES
SCREWDRIVERS
IMPACT
SLEEVE-DRIVE
PROTECTOR
INDUSTRIAL
AUTOMOTIVE
MOTORCYCLE
CONSTRUCTION
SPARE PART

102NM / 102NA Without reverse lever Nicht umstellbar Non réversible

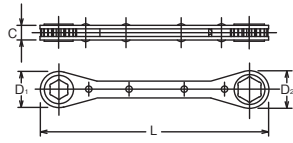

102NM (mm)	L (mm)	D ₁ (mm)	D ₂ (mm)	C (mm)	(g)	(pcs.)
6x7	108	15.3	16.4	7.5	60	10
7x8	108	15.3	16.4	7.5	60	10
8x9	134	17.1	19.7	7.5	80	10
8x10	134	17.1	19.7	7.5	80	10
10x11	140	20.1	22.7	7.5	87	10
10x12	140	20.1	22.7	7.5	87	10
11x13	145	23.6	24.6	9	112	10
12x13	145	23.6	24.6	9	112	10
12x14	145	23.6	24.6	9	112	10

102NA (inch)	L (mm)	D ₁ (mm)	D ₂ (mm)	C (mm)	(g)	(pcs.)
7/32 x 1/4	108	15.3	16.4	7.5	60	10
1/4 x 9/32	108	15.3	16.4	7.5	60	10
1/4 x 5/16	108	15.3	16.4	7.5	60	10
5/16 x 11/32	134	17.1	19.7	7.5	80	10
5/16 x 3/8	134	17.1	19.7	7.5	80	10
3/8 x 7/16	140	20.1	22.7	7.5	87	10
7/16 x 1/2	145	23.6	24.6	9	112	10
1/2 x 9/16	145	23.6	24.6	9	112	5

102KM / 102KA Reversible Umstellbar Réversible

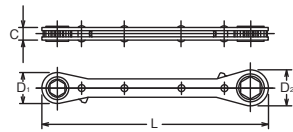

102KM (mm)	L (mm)	D ₁ (mm)	D ₂ (mm)	C (mm)	(g)	(pcs.)
6x7	108	15.3	16.4	7.2	51	10
7x8	108	15.3	16.4	7.2	51	10
8x9	134	17	20	9.1	76	10
8x10	134	17	20	9.1	76	10
10x11	141	21	23.5	9.1	84	10
10x12	141	21	23.5	9.1	84	10
12x13	146	24	25	9.1	89	10
12x14	146	24	25	9.1	89	5
13x17	200	27.1	31.8	11.5	190	5
14x17	200	27.1	31.8	11.5	200	5

102KA (inch)	L (mm)	D ₁ (mm)	D ₂ (mm)	C (mm)	(g)	(pcs.)
7/32 x 1/4	108	15.3	16.4	7.2	51	10
1/4 x 5/16	108	15.3	16.4	7.2	51	10
5/16 x 11/32	134	17	20	9	76	10
3/8 x 7/16	141	21	23.5	9.1	84	10
1/2 x 9/16	146	24	25	9.1	89	5

102KM.BH With Twin Openings (Two-in-One) Doppel-Ringschlüssel (zwei Öffnungen in einer) Ouvertures doubles

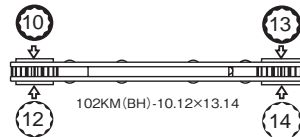

102KM.BH (mm)	L (mm)	D ₁ (mm)	D ₂ (mm)	C (mm)	(g)	(pcs.)
5.5- 6x 7- 8	108	15.3	16.4	10	60	10
8 ·10x12·13	141	21	23.5	13	87	10
9 ·10x11·12	141	21	23.5	13	87	10
10 ·12x13·14	146	24	25	13	98	10
13 ·14x15·17	200	27.1	31.8	16	200	5

102KT Reversible TORX® Umstellbar TORX® Réversible TORX®



102KT (E)	L (mm)	D ₁ (mm)	D ₂ (mm)	C (mm)	(g)	(pcs.)
E 4xE 6	108	15.3	16.4	7.5	51	10
E 6xE 8	108	15.3	16.4	7.5	51	10
E10xE12	134	17	20	9	76	10

103KM (mm)	L (mm)	D ₁ (mm)	D ₂ (mm)	C (mm)	(g)	(pcs.)
6x 7	108	15.3	16.4	7.5	51	5
7x 8	108	15.3	16.4	7.5	51	5
8x 9	134	17	20	9	76	5
8x10	134	17	20	9	76	5
10x11	140	21	23.5	9	84	5
10x12	140	21	23.5	9	84	5
12x13	145	24	25	9	89	5
12x14	145	24	25	9	89	5

103KA (inch)	L (mm)	D ₁ (mm)	D ₂ (mm)	C (mm)	(g)	(pcs.)
7/32x 1/4	108	15.3	16.4	7.5	51	5
1/4 x 5/16	108	15.3	16.4	7.5	51	5
5/16x11/32	134	17	20	9	76	5
5/16x 3/8	134	17	20	9	76	5
3/8 x 7/16	140	21	23.5	9	84	5
7/16x 1/2	145	24	25	9	89	5
1/2 x 9/16	145	24	25	9	89	5

103KA.BH (inch)	L (mm)	D ₁ (mm)	D ₂ (mm)	C (mm)	(g)	(pcs.)
1/4x5/16	108	15.3	16.4	7.5	51	5
3/8x7/16	140	21	23.5	9	84	5
1/2x9/16	145	24	25	9	89	5

103KT (E)	L (mm)	D ₁ (mm)	D ₂ (mm)	C (mm)	(g)	(pcs.)
E 4xE 6	104	15.3	16.4	7.5	51	5
E 6xE 8	104	15.3	16.4	7.5	51	5
E10xE12	128	17	20	9	76	5
E14xE16	139	24	25	9	89	5

145KM (mm)	L (mm)	D (mm)	C (mm)	(g)	(pcs.)
10H	125	20.1	7.5	72	10



150-10H (mm)	D (mm)	H (mm)	L (mm)	(g)	(pcs.)
5	12	3.5	11	6	10
6	12	4.5	12.5	7	10
7	12	5	14	7	10
8	12	6	15.5	7	10
9	13	6	16	7	10
10	14.3	7	17	9	10
12	17.4	9	19.5	14	10

1203		7 Pieces Set/△=250g	
METAL CASE:W130xH65xT20mm			
Sockets		Accessory	
150.10H 5, 6, 7, 8, 9, 10	145KM-10H		

103KM / 103KA Reversible
Umstellbar
Réversible

103KA.BH Reversible (12P)
Umstellbar (12P)
Réversible (12P)

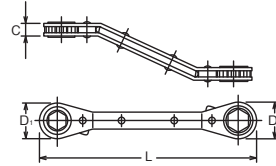

103KT Reversible TORX®
Umstellbar TORX®
Réversible TORX®

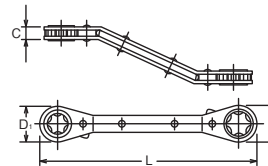
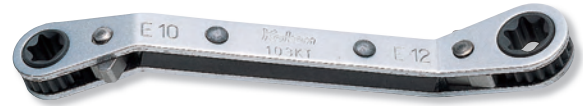

145KM-10H Reversible, 10mm 6-pt.
Verstellbar SW10mm
Réversible 10mm

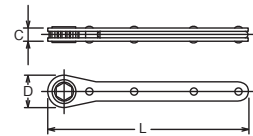

150-10H Sockets with 10mm 6-point Drive End
Steckschlüssel mit 10mm Sechskant-Antrieb
Douilles à conducteur de 10mm 6-pans mâle

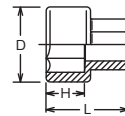

1203 Sockets with 10mm 6-point Drive End in Set with Ratchet
Steckschlüssel mit 10mm Sechskant-Antrieb mit Knarre im Satz
Jeu de douilles à conducteur 10mm 6-pans mâle, avec cliquet





Ratcheting Ring Spanners
 Knarren-Ringschlüssel
 Clés hexagonales à cliquet

Z-SERIES
 HAND
 TITANIUM
 ACCESSORIES
 SCREWDRIVERS
 IMPACT
 SLEEVE-DRIVE
 PROTECTOR
 INDUSTRIAL
 AUTOMOTIVE
 MOTORCYCLE
 CONSTRUCTION
 SPARE PART

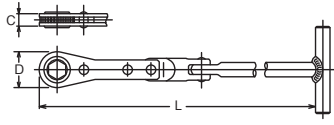

154M  Push and Pull-Ratchets
 Hub-Knarren
 Clé à cliquet de levage



154M (mm)	L (mm)	D (mm)	C (mm)	 (g)	 (pcs.)
8	294	17.1	7.5	178	2
10	297	20.1	7.5	183	2
12	300	23.6	9	189	2
13	301	24.6	9	194	2
14	301	24.6	9	194	2



154ML  Push and Pull-Ratchets
 Hub-Knarren
 Clé à cliquet de levage

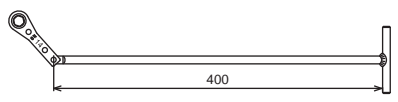

154ML (mm)	L (mm)	D (mm)	C (mm)	 (g)	 (pcs.)
10	297	20.1	7.5	230	2
12	300	23.6	9	252	2

1206  Push and Pull-Ratchet
 Hub-Knarre
 Clé à cliquet de levage



1206		3 Pieces Set/  =320g
CARDBOARD BOX		
Sockets		Accessory
 150.14H Sockets 12, 14	154K-14	

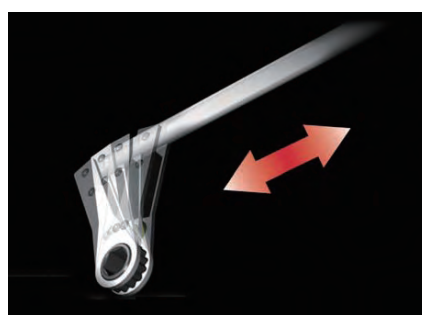

Ratcheting Ring Spanners Knarren-Ringschlüssel Clés hexagonales à cliquet

137	L (mm)	D ₁ (mm)	D ₂ (mm)	C (mm)	(g)	(pcs.)
	141	23.5	21	9	104	5

1/4" × 3/8"

138	L (mm)	D ₁ (mm)	D ₂ (mm)	C (mm)	(g)	(pcs.)
	141	23.5	21	9	97	10

1/4" × 1/4"

139	L (mm)	D (mm)	C (mm)	(g)	(pcs.)
	125	20.1	7.5	80	10

1/4"

R810 (inch)	L (mm)	D ₁ (mm)	D ₂ (mm)	C (mm)	(g)	(pcs.)
1/4×5/16	108	15.3	16.4	7.5	60	10
3/8×7/16	140	20.1	22.7	7.5	87	10
1/2×9/16	145	23.6	24.6	9	112	10

137 For 1/4" and 3/8" Square Drive Sockets
Für Steckschlüssel mit 1/4" und 3/8" Antrieb
Pour douilles d'un carré conducteur de 1/4" et 3/8"

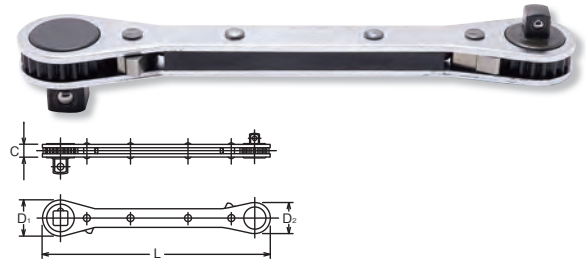

138 For Bits 101
Für Klängen 101
Pour embouts 101

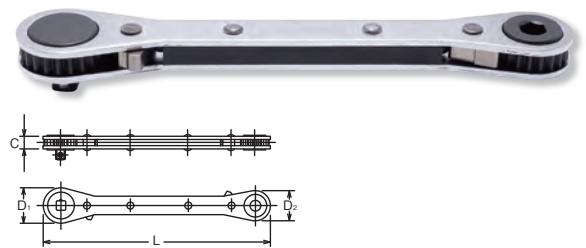

139 For 1/4" Square Drive Sockets
Für Steckschlüssel mit 1/4" Antrieb
Pour douilles d'un carré conducteur de 1/4"

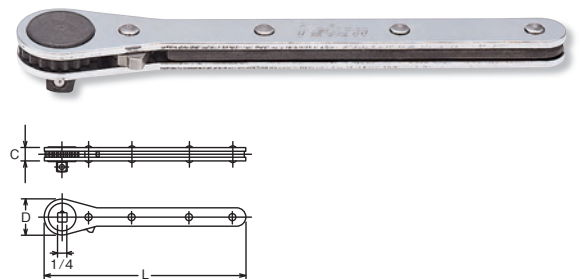

R810 Reversible (12P)
Umstellbar (12P)
Réversible (12P)

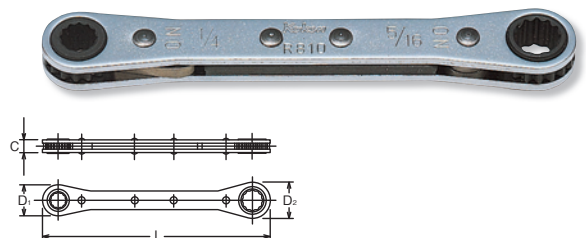

Z-SERIES
HAND
TITANIUM
ACCESSORIES
SCREWDRIVERS
IMPACT
SLEEVE-DRIVE
PROTECTOR
INDUSTRIAL
AUTOMOTIVE
MOTORCYCLE
CONSTRUCTION
SPARE PART

Ratcheting Ring Spanners

Knarren-Ringschlüssel

Clés hexagonales à cliquet

Z-SERIES
HAND
TITANIUM
ACCESSORIES
SCREWDRIVERS
IMPACT
SLEEVE-DRIVE
PROTECTOR
INDUSTRIAL
AUTOMOTIVE
MOTORCYCLE
CONSTRUCTION
SPARE PART

101P PH Bits PH Bits Embouts, PH

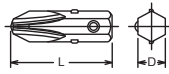

101P (PH)	D (mm)	L (mm)	(g)	(pcs.)
1	6.35	20.5	3	10
2	6.35	20.5	4	10
3	6.35	20.5	5	10

101S Slotted Bits Schlitz Bits Embouts, fente

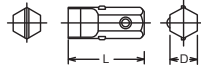

101S	D (mm)	L (mm)	(g)	(pcs.)
1.0x7	6.35	15	3	10
1.2x7	6.35	15	3	10

101H Hex Bits Sechskant Bits Embouts, 6 pans creux

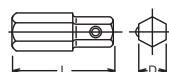

101H (mm)	D (mm)	L (mm)	(g)	(pcs.)
3	6.35	20.5	5	10
4	6.35	20.5	5	10
5	6.35	20.5	5	10
6	6.35	20.5	5	10
7	6.35	20.5	6	10
8	6.35	20.5	7	10

101B Ball-point Hex Bits Sechskant Bits Embouts, 6 pans creux

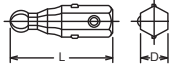

101B (mm)	D (mm)	L (mm)	(g)	(pcs.)
3	6.35	25	4	10
4	6.35	25	4	10
5	6.35	25	5	10
6	6.35	25	5	10

 Ball point bits have less strength due to the special design. Make sure to use them correctly.

101T (T) TORX® Bits TORX® Bits Embouts, TORX®

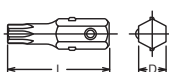

101T (T)	D (mm)	L (mm)	(g)	(pcs.)
T 9	6.35	25	4	10
T10	6.35	25	4	10
T15	6.35	25	5	10
T20	6.35	25	5	10
T25	6.35	25	5	10
T27	6.35	25	6	10
T30	6.35	25	6	10

101T (TH) Tamper-Resistant TORX® Bits TORX® Bits Embouts, TORX®

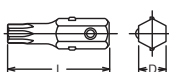

101T (TH)	D (mm)	L (mm)	(g)	(pcs.)
T10H	6.35	25	4	10
T15H	6.35	25	4	10
T20H	6.35	25	5	10
T25H	6.35	25	5	10
T27H	6.35	25	6	10
T30H	6.35	25	6	10

 Tamper Resistant TORX® Bits have less strength due to special design. Make sure to use it correctly.

128H (mm)	D (mm)	L (mm)	(g)	(pcs.)
3	8	32	11	10
4	8	32	11	10
5	8	32	12	10
6	8	32	12	10
8	8	32	13	10

128T (T)	D (mm)	L (mm)	(g)	(pcs.)
T10	8	32	9	10
T15	8	32	9	10
T20	8	32	9	10
T25	8	32	10	10
T27	8	32	10	10
T30	8	32	11	10

101A	D (mm)	S (mm)	L (mm)	(g)	(pcs.)
	8	6.35	20	8	10

128H Hex Bits
Sechskant Bits
Embouts, 6 pans creux

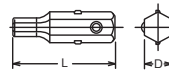

128T TORX® Bits
TORX® Bits
Embouts, TORX®

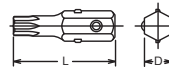



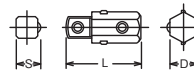

101A Adaptor
Verbindungsstück
Adaptateur

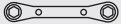

1202		15 Pieces Set/ 420g
METAL CASE: W190xH60xT30mm		
Bits		Accessory
<ul style="list-style-type: none"> 101P PH Bits 1, 2, 3 101S Slotted Bit 1x7 101B Ballpoint Hex Bits 3, 4, 5, 6 101T TORX® Bits T10, T15, T20, T25, T27, T30 	 138	

1202 Bit Set
Bit-Satz
Jeu d'embouts



2254M		12 Pieces Set/ 450g
METAL CASE: W160xH100xT28mm		
Bits		Accessories
<ul style="list-style-type: none"> 101P PH Bits 1, 2, 3 101S Slotted Bits 1x7, 1.2x7 101H Hex Bits 3, 4, 5 	 102NA-1/4x5/16  2769F  101A  2137	

2254M Bit Set
Bit-Satz
Jeu d'embouts



Ratcheting Ring Spanners Knarren-Ringschlüssel Clés hexagonales à cliquet

Z-SERIES
HAND
TITANIUM
ACCESSORIES
SCREWDRIVERS
IMPACT
SLEEVE-DRIVE
PROTECTOR
INDUSTRIAL
AUTOMOTIVE
MOTORCYCLE
CONSTRUCTION
SPARE PART

R810A Bit Set
Bit-Satz
Jeu d'embouts



R810A 5 Pieces Set/△=208g	
METAL CASE:W130xH65xT20mm	
Bits	Accessory
101P PH Bits 1, 2, 3 101S Slotted Bit 1x7	102NA-1/4x5/16

R810B Bit Set
Bit-Satz
Jeu d'embouts



R810B 10 Pieces Set/△=268g	
METAL CASE:W130xH65xT20mm	
Bits	Accessory
101P PH Bits 1, 2, 3 101S Slotted Bit 1x7 128H Hex Bits 3, 4, 5, 6, 8	102NA-1/4x5/16

R810C Bit and Socket Set
Bit und Steckschlüssel Satz
Jeu de douilles et d'embouts



R810C 12 Pieces Set/△=227g	
METAL CASE:W130xH65xT20mm	
Bits, Sockets	Accessories
101P PH Bits 1, 2, 3 101S Slotted Bit 1x7 2400M Sockets 5, 6, 7, 8, 9, 10	102NA-1/4x5/16 101A

R810D Bit and Socket Set
Bit und Steckschlüssel Satz
Jeu de douilles et d'embouts



R810D 17 Pieces Set/△=336g	
METAL CASE:W130xH65xT20mm	
Bits, Sockets	Accessories
101P PH Bits 1, 2, 3 101S Slotted Bit 1x7 128H Hex Bits 3, 4, 5, 6, 8 2400M Sockets 5, 6, 7, 8, 9, 10	102NA-1/4x5/16 101A

R810E Socket Set
Steckschlüssel Satz
Jeu de clés à douilles



R810E 9 Pieces Set/△=445g	
METAL CASE:W130xH65xT20mm	
Sockets	Accessories
2300M Deep Sockets 6, 7, 8, 9, 10, 11, 12	102NA-1/4x5/16 101A



156M  6-Point Deep
6-kant, lang
Longues 6-pans

156M (mm)	D (mm)	H ₁ (mm)	H ₂ (mm)	L ₁ (mm)	L ₂ (mm)	(g)	(pce.)
8	12	9	41	355	200	231	1
10	14.5	11	41	355	200	289	1
12	16.8	13	41	355	200	429	1
14	20	16	41	355	200	454	1

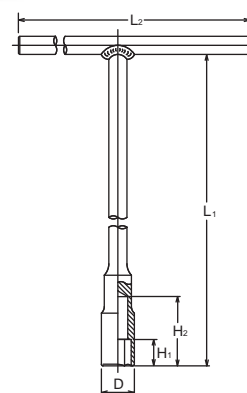

104ME / 104A  6-Point
6-kant
6-pans

104ME (mm)	D (mm)	H (mm)	L ₁ (mm)	L ₂ (mm)	(g)	(pce.)
6	9.5	8	200	180	150	1
7	11	9	200	180	152	1
8	12	10	250	200	183	1
9	14	12	250	200	188	1
10	14	13	250	200	230	1
11	16	14	250	200	234	1
12	18	15	250	200	355	1
13	18.5	17	250	250	390	1
14	20	18	250	250	399	1
15	21	19	250	250	404	1
16	22.5	21	250	250	419	1
17	24	22	250	250	568	1
18	25	23	250	250	577	1
19	26.5	25	250	250	594	1
New 21	29	27	350	300	1070	1
New 22	30	28	350	300	1062	1
New 24	33	30	350	300	1140	1

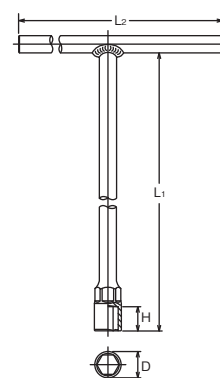

104A (inch)	D (mm)	H (mm)	L ₁ (mm)	L ₂ (mm)	(g)	(pce.)
1/4	9.5	8	200	180	150	1
5/16	12	10	250	200	183	1
3/8	14	12	250	200	188	1
7/16	16	14	250	200	234	1
1/2	18.5	17	300	250	412	1
9/16	20	18	300	250	428	1
5/8	22.5	21	350	300	528	1
3/4	26.5	25	350	300	717	1

Z-SERIES
HAND
TITANIUM
ACCESSORIES
SCREWDRIVERS
IMPACT
SLEEVE-DRIVE
PROTECTOR
INDUSTRIAL
AUTOMOTIVE
MOTORCYCLE
CONSTRUCTION
SPARE PART

Z-SERIES
HAND
TITANIUM
ACCESSORIES
SCREWDRIVERS
IMPACT
SLEEVE-DRIVE
PROTECTOR
INDUSTRIAL
AUTOMOTIVE
MOTORCYCLE
CONSTRUCTION
SPARE PART

3116M  Universal with 6-point Socket
Gelenk mit 6-kant Steckschlüssel
Cardan avec douille 6-pans

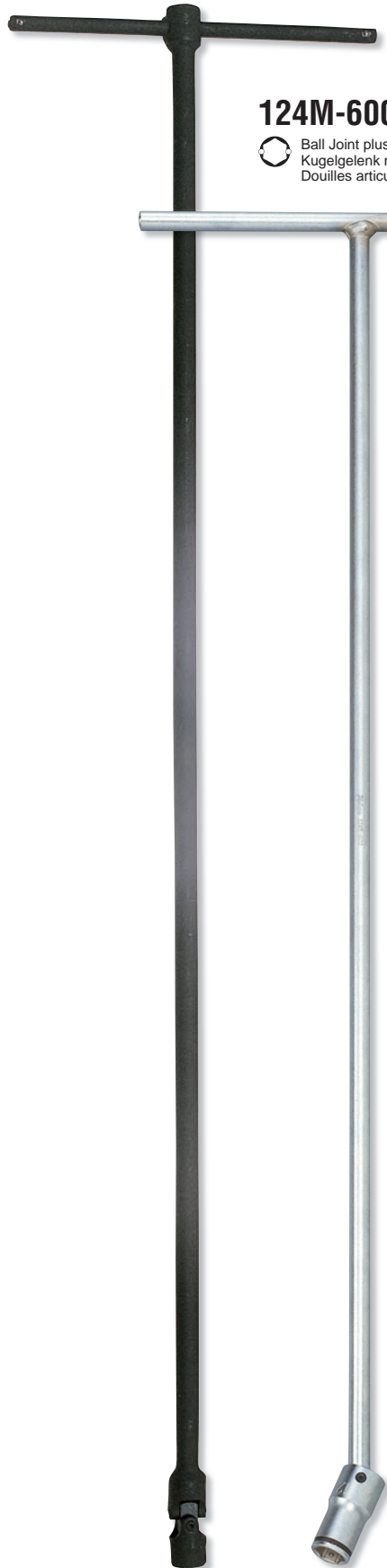

124M-600 (2B)

 Ball Joint plus Nut Grip Socket
Kugelgelenk mit 2-facher Kugelhalterung
Douilles articulées avec deux billes de retenue

3116M (mm)	D (mm)	H (mm)	L ₁ (mm)	L ₂ (mm)	(g)	(pce.)
10	14.5	8	800	190	796	1
12	17	10.3	800	190	797	1
13	18	11.3	800	190	797	1
14	19.5	11.3	800	190	797	1
15	21	12.8	800	190	799	1
16	22	12.8	800	190	806	1
17	23.6	13.8	800	190	801	1
18	24	13.8	800	190	809	1

124M-600 (mm)	D (mm)	H (mm)	L ₁ (mm)	L ₂ (mm)	(g)	(pce.)
8(2B)	12	5	600	200	332	1
10(2B)	14.5	6	600	200	334	1
12(2B)	16.8	7	600	200	424	1
13(2B)	18	8	600	200	425	1
14(2B)	19.5	8.5	600	200	527	1
17(2B)	23.3	9.5	600	200	538	1

NUT GRIP®

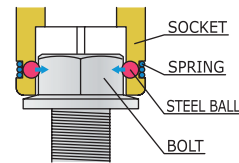

NUT GRIP®

Twin balls at the 6-point opening hold bolt/nut tightly for safe and reliable work.
Die zwei Kugeln in der 6-kant Öffnung unserer NUT GRIP Steckschlüssel halten die Schraube sicher im Steckschlüssel. Dies erlaubt ein Arbeiten auch an schwer zugänglichen Stellen.
Les 2 billes dans l'ouverture du 6-pans de la douille retiennent l'écrou de manière sûre et efficace.

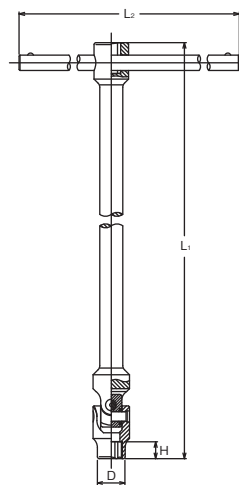



photo: 3116M

157HE  For Inhex Screws
Für Innensechskant-Schrauben
Pour vis à 6-pans creux

157HE (mm)	L ₁ (mm)	L ₂ (mm)	(g)	(pce.)
3	250	180	98	1
4	250	180	121	1
5	250	180	158	1
6	250	180	416	1
8	250	180	422	1
10	300	190	440	1
12	320	210	660	1

157T  For TORX® Screws
Für TORX®-Schrauben
Pour vis TORX®

157T (T)	L ₁ (mm)	L ₂ (mm)	(g)	(pce.)
T25	250	180	95	1
T27	250	180	96	1
T30	250	180	167	1
T40	250	180	168	1
T45	250	180	213	1
T50	250	180	215	1

157S  For Slotted Heads
Für Schlitzschrauben
Pour vis à fente

157S	TxW	L ₁ (mm)	L ₂ (mm)	(g)	(pce.)
6	1.0x6	200	180	84	1
8	1.2x8	250	180	170	1

157PE  For PH Screws
Für Kreuzschlitzschrauben, PH
Pour vis à empreinte PH

157PE (PH)	L ₁ (mm)	L ₂ (mm)	(g)	(pce.)
2	250	180	95	1
3	250	180	170	1

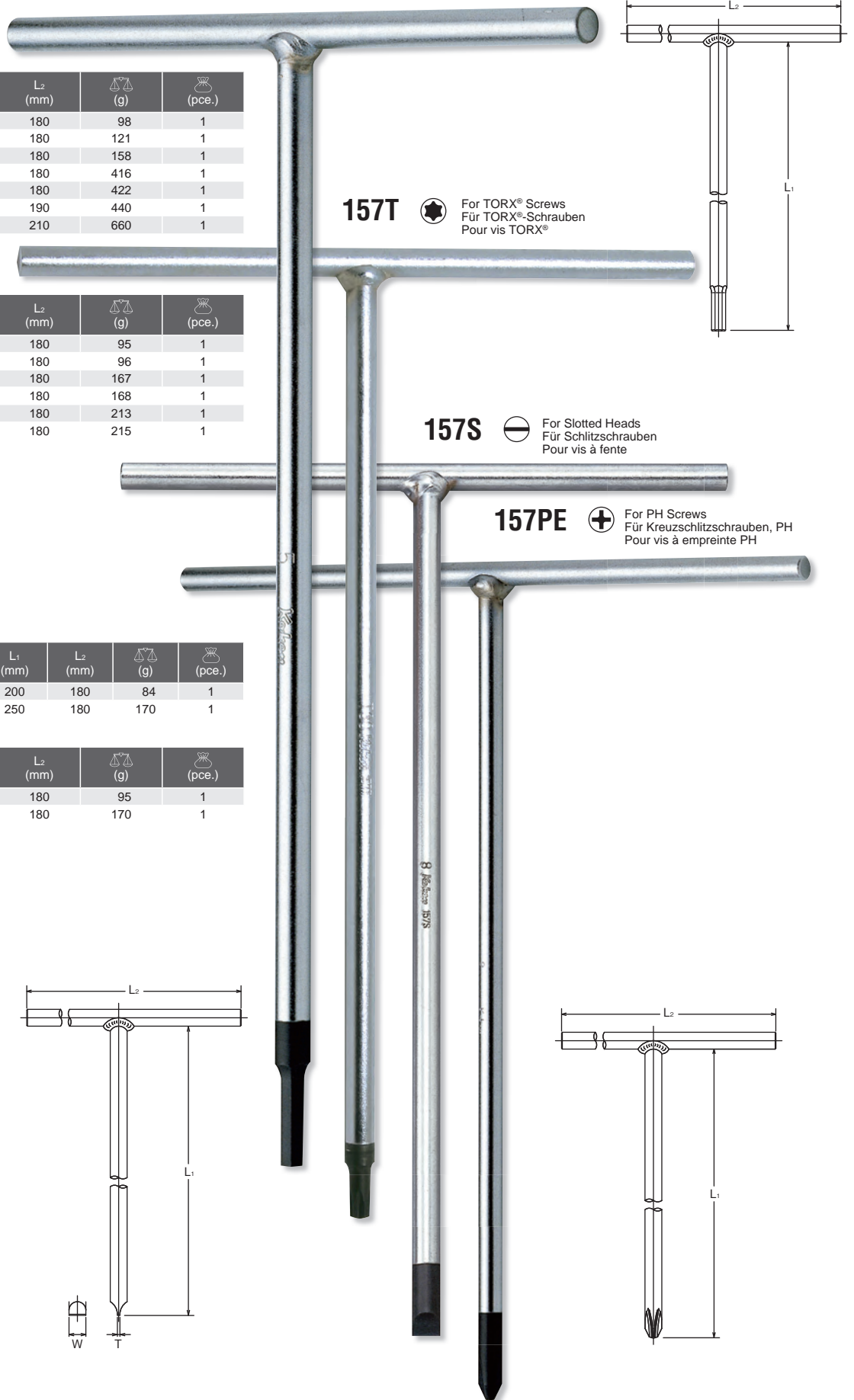

T-Handles
T-Griffe
Poignées en T

Z-SERIES
HAND
TITANIUM
ACCESSORIES
SCREWDRIVERS
IMPACT
SLEEVE-DRIVE
PROTECTOR
INDUSTRIAL
AUTOMOTIVE
MOTORCYCLE
CONSTRUCTION
SPARE PART

2715  T-Handle
T-Griff
Poignée coulissante



3715  T-Handle
T-Griff
Poignée coulissante



3715S  T-Handle
T-Griff
Poignée coulissante



3715SL  T-Handle
T-Griff
Poignée coulissante



OVAL SHAPE SHANK



3715SLK  T-handle with freewheel handle
T-Griff mit freilauf Hülse
Poignée en T avec poignée libre







3716  T-Handle
T-Griff
Poignée coulissante

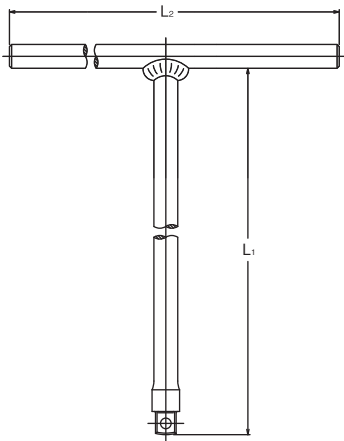

WOBBLE-FIX EXTENSION BAR



		L ₁ (mm)	L ₂ (mm)	 (g)	 (pce.)
2715		200	120	130	1

		L ₁ (mm)	L ₂ (mm)	 (g)	 (pce.)
3715		268	240	386	1
3715S		268	190	347	1
3715SL		237	200	325	1
3715SLK		236	200	470	1
3716		268	240	379	1

3716

3716 has a reduced square drive and similar function as offset extension bars.



photo: 3715SLK



4715  T-Handle
T-Griff
Poignée coulissante







4715S  T-Handle
T-Griff
Poignée coulissante

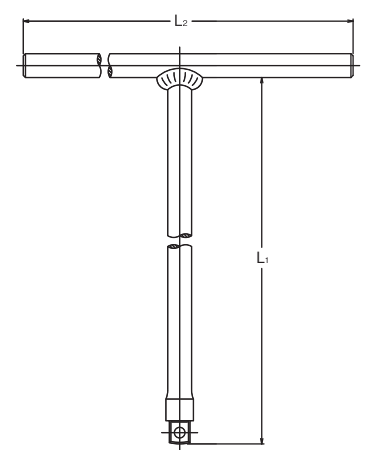





4715SL  T-Handle
T-Griff
Poignée coulissante

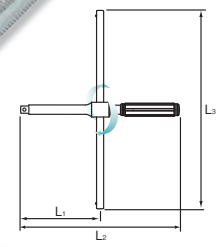
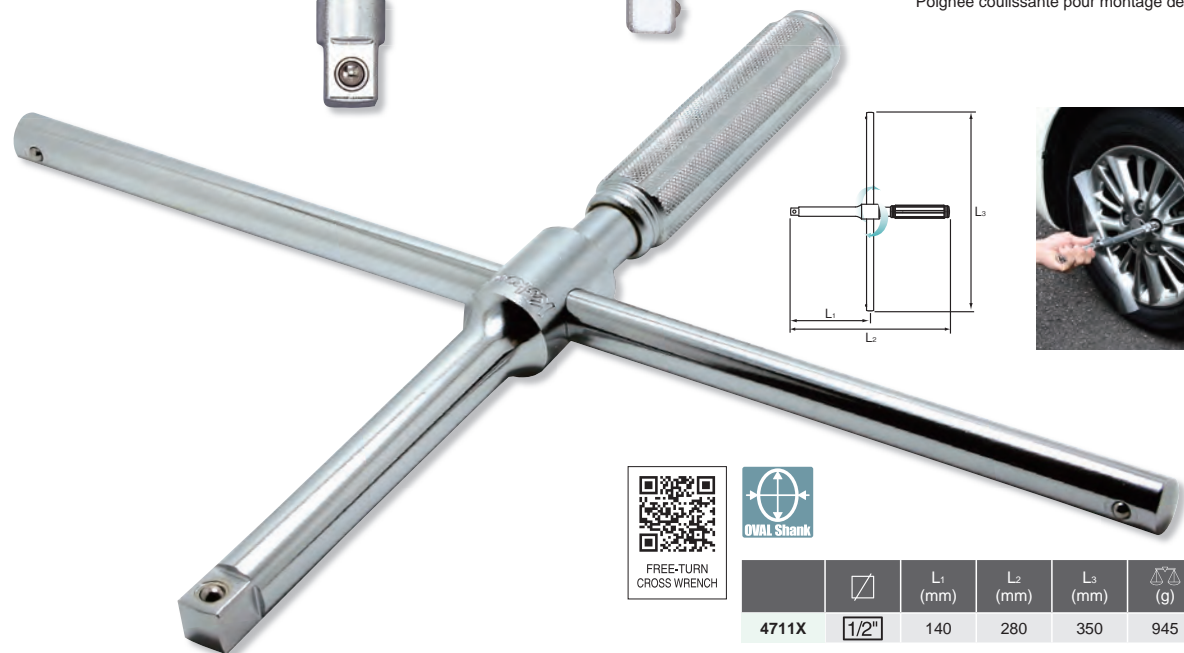

		L ₁ (mm)	L ₂ (mm)	 (g)	 (pce.)
4715		267	255	475	1
4715S		267	170	402	1
4715SL		250	250	640	1

4711X  Spinning cross wrench
T-Griff für die Radmuttermontage
Poignée coulissante pour montage des écrous à roue



		L ₁ (mm)	L ₂ (mm)	L ₃ (mm)	 (g)	 (pce.)
4711X		140	280	350	945	1

Attack Drivers

Hand-Schlagschrauber

Tournevis à frapper

Z-SERIES
HAND
TITANIUM
ACCESSORIES
SCREWDRIVERS
IMPACT
SLEEVE-DRIVE
PROTECTOR
INDUSTRIAL
AUTOMOTIVE
MOTORCYCLE
CONSTRUCTION
SPARE PART

3112G Attack Driver
Handschlagschrauber
Tournevis à frapper



		L (mm)	 (g)	 (pce.)
3112G	3/8"	159	810	1



4112G Attack Driver
Handschlagschrauber
Tournevis à frapper



		L (mm)	 (g)	 (pce.)
4112G	1/2"	163	810	1
4112N	1/2"	163	730	1

* 4112N Renewal Kits → **4112RK** → **P319**

4112N Attack Driver
Handschlagschrauber
Tournevis à frapper



		L (mm)	 (g)	 (pce.)
6112	3/4"	190	1900	1

* Renewal Kits → **6112RK** → **P319**



Black finished striking head prevents the problem of peeling.
Das geschwärzte Schlagende vermeidet das Abspringen von Chromteilen.
La finition "black finish" de la tête évite l'écaillage dû au chromage.

6112 Attack Driver
Handschlagschrauber
Tournevis à frapper

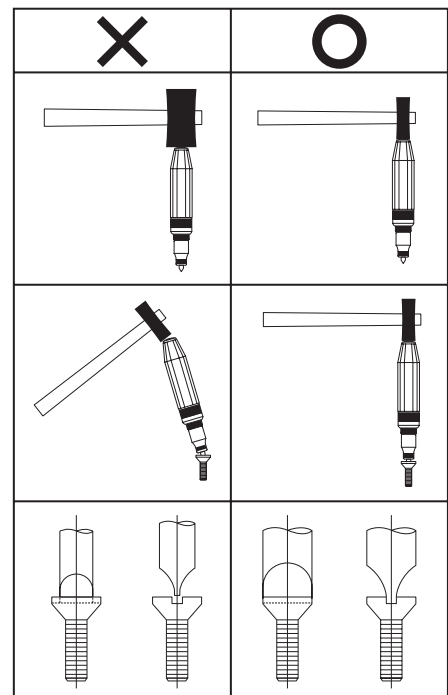

AG318A 6 Pieces Set/△=1,150g
METAL CASE:W220xH82xT60mm

Bits	Accessories
100P.32 PH Bits 2, 3	3112G
100S.32 Slotted Bits 9, 11	3138

AG112A 6 Pieces Set/△=1,150g

METAL CASE:W220xH82xT60mm

Bits	Accessories
100P.32 PH Bits 2, 3	4112G
100S.32 Slotted Bits 9, 11	4138

100P, S Bits → P168

AG112H 18 Pieces Set/△=1,480g

METAL CASE:W220xH82xT60mm

Bits	Accessories
100P.32 PH Bits 2, 3, 4	4112G
100S.32 Slotted Bits 8, 9, 10, 12, 14	4138
100H.32 Hex Bits 5, 6, 8, 10	
100T.32 TORX® Bits T30, T40, T45, T50	

100P, S, H, T Bits → P168

AG112F 25 Pieces Set/△=1,530g

METAL CASE:W220xH82xT60mm

Bits	Accessories
100P.32 PH Bits 2, 3	4112G
100P.32 PZ Bits PZ2, PZ3	4138
100S.32 Slotted Bits 9, 11	
100H.32 Hex Bits 4, 5, 6, 7, 8, 10	
100T.32 TORX® Bits T25, T27, T30, T40, T45, T50	
100X.32 XZN Bits M5, M6, M8, M10, M12	

100P, S, H, T, X Bits → P168-169

AN112A 6 Pieces Set/△=1,070g

METAL CASE:W190xH59xT45mm

Bits	Accessories
100P.32 PH Bits 2, 3	4112N
100S.32 Slotted Bits 9, 11	4138

100P, S Bits → P168

AN112C 8 Pieces Set/△=1,350g

METAL CASE:W220xH82xT60mm

Bits	Accessories
100P.80 PH Bits 1, 2, 3	4112N
100S.80 Slotted Bits 7, 9, 12	4138

100P, S Bits → P168

AG318A Attack Driver Set
Handschlagschrauber-Satz
Jeu de tournevis à frapper



AG112H Attack Driver Set
Handschlagschrauber-Satz
Jeu de tournevis à frapper



AG112F Attack Driver Set
Handschlagschrauber-Satz
Jeu de tournevis à frapper



AN112A Attack Driver Set
Handschlagschrauber-Satz
Jeu de tournevis à frapper



AN112C Attack Driver Set
Handschlagschrauber-Satz
Jeu de tournevis à frapper



108P-25 / -32 / -50  PH Bits
PH Bits
Embouts, PH



108S-25 / -39  Slotted Bits
Schlitz Bits
Embouts, fente

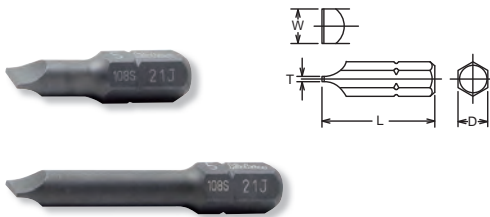

108H-25  Hex Bits
Sechskant Bits
Embouts, 6 pans creux



108T-25 (T)  TORX® Bits
TORX® Bits
Embouts, TORX®



108T-25 (TH)  Tamper-Resistant TORX® Bits
Tamper-Resistant TORX® Bits
Embouts TORX®, Tamper-Resistant 



 Tamper resistant TORX® Bits have less strength due to special design.
Make sure to use it correctly.

Die manipulationsicheren TORX®-Bits haben aufgrund ihres speziellen Designs eine geringere Festigkeit.
Achten Sie darauf, sie richtig zu verwenden.

Les embouts TORX® à l'abri de manipulation sont moins résistants en raison de leur conception spéciale.
Veuillez les utiliser correctement.

108A  Adaptor
Verbindungsstück
Adaptateur



108P-25 (PH)	D (mm)	L (mm)	(g)	(pcs.)
1	6.35	25	5	10
2	6.35	25	5	10
3	6.35	25	6	10

108P-32 (PH)	D (mm)	L (mm)	(g)	(pcs.)
1	6.35	32	7	10
2	6.35	32	7	10
3	6.35	32	8	10

108P-50 (PH)	D (mm)	L (mm)	(g)	(pcs.)
1	6.35	50	10	10
2	6.35	50	11	10
3	6.35	50	11	10

108S-25	TxW (mm)	D (mm)	L (mm)	(g)	(pcs.)
3	0.5x3	6.35	25	3	10
4	0.6x4	6.35	25	3	10
4.5	0.6x4.5	6.35	25	4	10
5	0.8x5	6.35	25	5	10
5.5	0.8x5.5	6.35	25	5	10
6	1.0x6	6.35	25	5	10
8	1.2x8	6.35	25	6	10

108S-39	TxW (mm)	D (mm)	L (mm)	(g)	(pcs.)
3	0.5x3	6.35	39	6	10
4	0.6x4	6.35	39	6	10
4.5	0.6x4.5	6.35	39	6	10
5	0.8x5	6.35	39	7	10
5.5	0.8x5.5	6.35	39	8	10
6	1.0x6	6.35	39	9	10
8	1.2x8	6.35	39	12	10

108H-25 (mm)	D (mm)	L (mm)	(g)	(pcs.)
3	6.35	25	4	10
4	6.35	25	5	10
5	6.35	25	5	10
6	6.35	25	6	10
7	6.35	25	7	10
8	6.35	25	8	10
10	6.35	25	11	10

108H-25 (inch)	D (mm)	L (mm)	(g)	(pcs.)
1/8	6.35	25	4	10
9/64	6.35	25	5	10
5/32	6.35	25	5	10
3/16	6.35	25	5	10
7/32	6.35	25	6	10
1/4	6.35	25	7	10

108T-25 (T)	D (mm)	L (mm)	(g)	(pcs.)
T 8	6.35	25	4	10
T10	6.35	25	4	10
T15	6.35	25	4	10
T20	6.35	25	5	10
T25	6.35	25	6	10
T27	6.35	25	6	10
T30	6.35	25	6	10
T40	6.35	25	6	10

108T-25 (TH)	D (mm)	L (mm)	(g)	(pcs.)
T10H	6.35	25	4	10
T15H	6.35	25	4	10
T20H	6.35	25	5	10
T25H	6.35	25	6	10
T27H	6.35	25	6	10
T30H	6.35	25	6	10
T40H	6.35	25	6	10

108A-25	D (mm)	L (mm)	(g)	(pcs.)
1/4B	6.35	25	10	10

		D ₁ (mm)	D ₂ (mm)	L (mm)	(g)	(pcs.)
2137	1/4"	12	12	22.5	13	10
3137	3/8"	13	16.5	30	30	10
4137	1/2"	13	22	38	53	10

For DIN3126 C6.3 Bits
Für DIN3126 C6.3 Bits
Pour DIN3126 C6.3 Embouts

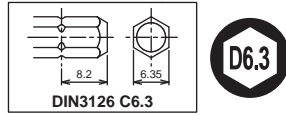

- 2137 Bit Holder
Klingenhalter
Porte-embouts
- 3137
- 4137

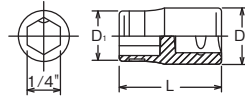

		D ₁ (mm)	D ₂ (mm)	L (mm)	(g)	(pcs.)	
12139	1/4"	11	13	25	15	10	*1
13139	3/8"	11	19	30	32	10	*2
14139	1/2"	11	25	35	62	10	*3

*1 Pin/O-Ring=A21/B21
*2 C-Ring=C31,Pin/O-Ring=A31/B31
*3 C-Ring=C41,Pin/O-Ring=A41/B41

→ P268-269

For DIN3126 C6.3 Bits
Für DIN3126 C6.3 Bits
Pour DIN3126 C6.3 Embouts

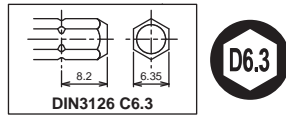

- 12139 Impact Bit Holder
Impact Klingenhalter
Porte embouts Impact
- 13139
- 14139

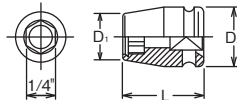

		D ₁ (mm)	D ₂ (mm)	L (mm)	(g)	(pcs.)	
13142-D6.3	3/8"	16	19	45	60	10	*1
14142-D6.3	1/2"	16	25	55	97	10	*2

*1 C-Ring=C31,Pin/O-Ring=A31/B31
*2 C-Ring=C41,Pin/O-Ring=A41/B41

→ P268-269

For DIN3126 C6.3 Bits
Für DIN3126 C6.3 Bits
Pour DIN3126 C6.3 Embouts

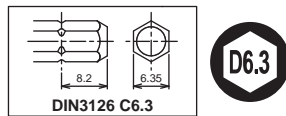

- 13142-D6.3 Impact Bit Holder
Impact Klingenhalter
Porte embouts Impact
- 14142-D6.3

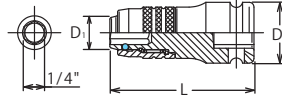

You may not hold the sliding part while moving to avoid heating up by friction and reduction by wear.
Bitte das gleitende Teil während der Bewegung nicht festhalten, um eine Erhitzung durch Reibung und durch Verschleiß zu vermeiden.
Vous ne devez pas tenir la partie coulissante pendant le déplacement afin d'éviter l'échauffement par frottement et la réduction par usure la réduction par l'usure.

Lock & Quick Release

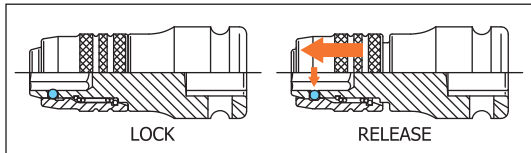

	D (mm)	H (mm)	L (mm)	(g)	(pcs.)
2749P-1/4HF	25	12	125	96	1
2774P-1/4HF	25	12	165	133	1

For DIN3126 C6.3 Bits
Für DIN3126 C6.3 Bits
Pour DIN3126 C6.3 Embouts

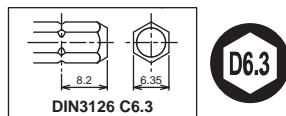

- 2749P-1/4HF Reversible Ratchet, for Bits 1/4"
Knarre, verstellbar, für Bits 1/4"
Cliquet, réversible pour embouts 1/4"



- 2774P-1/4HF Flexible Ratchet, reversible, for Bits 1/4"
Gelenk-Knarre, verstellbar, für Bits 1/4"
Cliquet à tête articulée pour embouts 1/4"

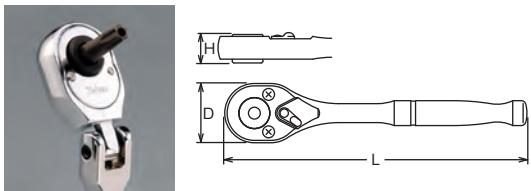

	D (mm)	H (mm)	L (mm)	(g)	(pcs.)
180M-50	11	13.5	50	15	10

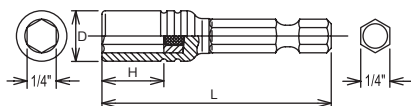

- 180M-50 Bit Holder with Magnet
Klingenhalter mit Magnet
Porte-embouts avec aimant



Z-SERIES
HAND
TITANIUM
ACCESSORIES
SCREWDRIVERS
IMPACT
SLEEVE-DRIVE
PROTECTOR
INDUSTRIAL
AUTOMOTIVE
MOTORCYCLE
CONSTRUCTION
SPARE PART

100P-32 / -80 / -125 PH Bits PH Bits Embouts, PH

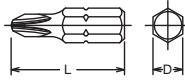

100P-32 (PH)	D (mm)	L (mm)	(g)	(pcs.)
1	8	32	11	10
2	8	32	11	10
3	8	32	12	10
4	8	32	12	10

100P-80 (PH)	D (mm)	L (mm)	(g)	(pcs.)
1	8	80	30	10
2	8	80	30	10
3	8	80	31	10
4	8	80	32	10

100P-125 (PH)	D (mm)	L (mm)	(g)	(pcs.)
2	8	125	48	10
3	8	125	49	10

100P-32 (PZ) PZ Bits PZ Bits Embouts, PZ

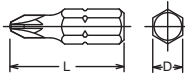

100P-32 (PZ)	D (mm)	L (mm)	(g)	(pcs.)
PZ2	8	32	10	10
PZ3	8	32	11	10

100S-32 / -80 Slotted Bits Schlitz Bits Embouts, fente

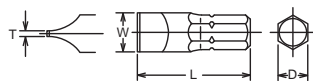

100S-32	TxW (mm)	D (mm)	L (mm)	(g)	(pcs.)
6	1 x 6	8	32	10	10
7	1 x 7	8	32	11	10
8	1.2x 8	8	32	12	10
9	1.6x 9	8	32	12	10
10	1.6x10	8	32	13	10
11	1.6x11	8	32	15	10
12	2 x12	8	32	18	10
14	2 x14	8	32	21	10

100S-80	TxW (mm)	D (mm)	L (mm)	(g)	(pcs.)
6	1 x 6	8	80	29	10
7	1 x 7	8	80	30	10
8	1.2x 8	8	80	31	10
9	1.6x 9	8	80	32	10
10	1.6x10	8	80	33	10
11	1.6x11	8	80	33	10
12	2 x12	8	80	34	10
14	2 x14	8	80	37	10

100H-32 Hex Bits Sechskant Bits Embouts, 6 pans creux

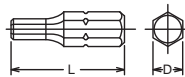

100H-32 (mm)	D (mm)	L (mm)	(g)	(pcs.)
3	8	32	11	10
4	8	32	11	10
5	8	32	12	10
6	8	32	12	10
7	8	32	13	10
8	8	32	13	10
9	8	32	16	10
10	8	32	16	10
11	8	32	20	10
12	8	32	23	10
14	8	32	29	10

100T-32 (T) TORX® Bits TORX® Bits Embouts, TORX®

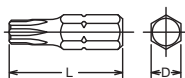

100T-32 (T)	D (mm)	L (mm)	(g)	(pcs.)
T10	8	32	9	10
T15	8	32	9	10
T20	8	32	9	10
T25	8	32	10	10
T27	8	32	10	10
T30	8	32	11	10
T40	8	32	12	10
T45	8	32	12	10
T50	8	32	12	10
T55	8	32	12	10

100T-32 (TH)	D (mm)	L (mm)	(g)	(pcs.)
T10H	8	32	9	10
T15H	8	32	9	10
T20H	8	32	9	10
T25H	8	32	10	10
T27H	8	32	10	10
T30H	8	32	11	10
T40H	8	32	12	10
T45H	8	32	12	10
T50H	8	32	12	10
T55H	8	32	12	10

100X-32	D (mm)	L (mm)	(g)	(pcs.)
M 5	8	32	10	10
M 6	8	32	11	10
M 8	8	32	12	10
M10	8	32	16	10
M12	8	32	19	10

	□	D ₁ (mm)	D ₂ (mm)	L (mm)	(g)	(pcs.)
2138	1/4"	16	16	26	32	10
3138	3/8"	16	18	38	55	10
4138	1/2"	16	22	38	62	10

For DIN3126 C8 Bits
Für DIN3126 C8 Bits
Pour DIN3126 C8 Embouts

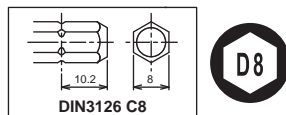

	□	D ₁ (mm)	D ₂ (mm)	L (mm)	(g)	(pcs.)	⚡
12140	1/4"	14	13	25	15	10	*1
13140	3/8"	14	19	30	32	10	*2
14140	1/2"	14	25	35	62	10	*3

*1 Pin/O-Ring=A21/B21
*2 C-Ring=C31,Pin/O-Ring=A31/B31
*3 C-Ring=C41,Pin/O-Ring=A41/B41

→ P268-269

For DIN3126 C8 Bits
Für DIN3126 C8 Bits
Pour DIN3126 C8 Embouts

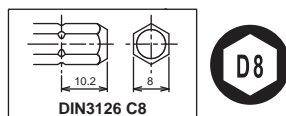

	D (mm)	H (mm)	L (mm)	(g)	(pcs.)
2749P-5/16HF	25	14	125	96	1
2774P-5/16HF	25	14	165	133	1

For DIN3126 C8 Bits
Für DIN3126 C8 Bits
Pour DIN3126 C8 Embouts

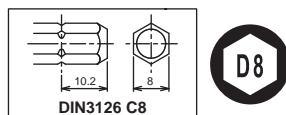

100T-32 (TH) Tamper-Resistant TORX® Bits Tamper-Resistant TORX® Bits Embouts TORX®, Tamper-Resistant

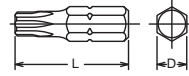

Tamper resistant TORX® Bits have less strength due to special design. Make sure to use it correctly.
Die manipulations-sicheren TORX®-Bits haben aufgrund ihres speziellen Designs eine geringere Festigkeit. Achten Sie darauf, sie richtig zu verwenden.

Les embouts TORX® à l'abri de manipulations sont moins résistants en raison de leur conception spéciale. Veuillez les utiliser correctement.

100X-32 (XZN) XZN Bits XZN Bits Embouts, XZN

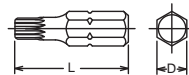

2138 Bit Holder Klingenhalter

3138 Porte-embouts

4138

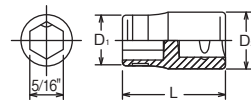

12140 Impact Bit Holder Impact Klingenhalter

13140 Impact Porte embouts Impact

14140

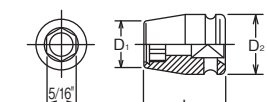

2749P-5/16HF Reversible Ratchet, for Bits 5/16" Knarre, verstellbar für Bits 5/16" Cliquet, réversible pour embouts 5/16"



2774P-5/16HF Flexible Ratchet, reversible, for Bits 5/16" Gelenk-Knarre, verstellbar, für Bits 5/16" Cliquet à tête articulée pour embouts 5/16"

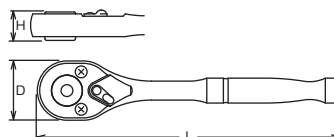

121P-50 / -70 / -100 / -150  PH Bits
PH Bits
Embouts, PH

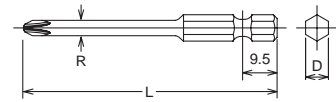

121P-50 (PH)	D (mm)	R (mm)	L (mm)	(g)	(pcs.)
1	6.35	4.5	50	12	10
2	6.35	5.5	50	12	10
3	6.35	-	50	13	10

121P-70 (PH)	D (mm)	R (mm)	L (mm)	(g)	(pcs.)
1	6.35	4.5	70	15	10
2	6.35	5.5	70	15	10
3	6.35	-	70	16	10

121P-100 (PH)	D (mm)	R (mm)	L (mm)	(g)	(pcs.)
1	6.35	4.5	100	23	10
2	6.35	5.5	100	23	10
3	6.35	-	100	24	10

121P-150 (PH)	D (mm)	R (mm)	L (mm)	(g)	(pcs.)
1	6.35	4.5	150	30	10
2	6.35	5.5	150	35	10
3	6.35	-	150	36	10

121H-50 / -70 / -100 / -150  Hex Bits
Sechskant Bits
Embouts, 6 pans creux

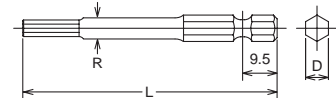

121H-50 (mm)	D (mm)	R (mm)	L (mm)	(g)	(pcs.)
2	6.35	3	50	11	10
2.5	6.35	3	50	12	10
3	6.35	3.5	50	12	10
4	6.35	4.5	50	12	10
5	6.35	5.6	50	13	10
6	6.35	-	50	14	10

121H-70 (mm)	D (mm)	R (mm)	L (mm)	(g)	(pcs.)
2	6.35	3	70	13	10
2.5	6.35	3	70	15	10
3	6.35	3.5	70	15	10
4	6.35	4.5	70	15	10
5	6.35	5.6	70	16	10
6	6.35	-	70	18	10

121H-100 (mm)	D (mm)	R (mm)	L (mm)	(g)	(pcs.)
2	6.35	3	100	22	10
2.5	6.35	3	100	23	10
3	6.35	3.5	100	23	10
4	6.35	4.5	100	23	10
5	6.35	5.6	100	24	10
6	6.35	-	100	26	10

121H-150 (mm)	D (mm)	R (mm)	L (mm)	(g)	(pcs.)
2	6.35	3.5	150	35	10
2.5	6.35	3.5	150	35	10
3	6.35	3.5	150	37	10
4	6.35	4.5	150	37	10
5	6.35	5.6	150	38	10
6	6.35	-	150	39	10

121T-50 / -70 / -100 / -150 (T)  TORX® Bits
TORX® Bits
Embouts, TORX®

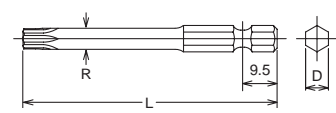

121T-50 (T)	D (mm)	R (mm)	L (mm)	(g)	(pcs.)
T10	6.35	3	50	12	10
T15	6.35	3.5	50	12	10
T20	6.35	4.1	50	12	10
T25	6.35	4.6	50	12	10
T27	6.35	5.2	50	13	10
T30	6.35	5.7	50	13	10
T40	6.35	-	50	14	10

121T-70 (T)	D (mm)	R (mm)	L (mm)	(g)	(pcs.)
T10	6.35	3.5	70	16	10
T15	6.35	3.5	70	16	10
T20	6.35	4.1	70	16	10
T25	6.35	4.6	70	16	10
T27	6.35	5.2	70	17	10
T30	6.35	5.7	70	17	10
T40	6.35	-	70	18	10

121T-100 (T)	D (mm)	R (mm)	L (mm)	(g)	(pcs.)
T10	6.35	3.5	100	24	10
T15	6.35	3.5	100	24	10
T20	6.35	4.1	100	24	10
T25	6.35	4.6	100	24	10
T27	6.35	5.2	100	24	10
T30	6.35	5.7	100	25	10
T40	6.35	-	100	26	10

121T-150 (T)	D (mm)	R (mm)	L (mm)	(g)	(pcs.)
T10	6.35	3.5	150	35	10
T15	6.35	3.5	150	37	10
T20	6.35	4.1	150	37	10
T25	6.35	4.6	150	37	10
T27	6.35	5.2	150	37	10
T30	6.35	5.7	150	38	10
T40	6.35	-	150	39	10

121T-70 (TH)	D (mm)	R (mm)	L (mm)	(g)	(pcs.)
T15H	6.35	3.5	70	15	10
T20H	6.35	4.1	70	16	10
T25H	6.35	4.6	70	16	10
T27H	6.35	5.2	70	17	10
T30H	6.35	5.7	70	17	10
T40H	6.35	-	70	18	10

121T-100 (TH)	D (mm)	R (mm)	L (mm)	(g)	(pcs.)
T15H	6.35	3.5	100	22	10
T20H	6.35	4.1	100	24	10
T25H	6.35	4.6	100	24	10
T27H	6.35	5.2	100	24	10
T30H	6.35	5.7	100	25	10
T40H	6.35	-	100	26	10

121T-50 (IP)	D (mm)	R (mm)	L (mm)	(g)	(pcs.)
20IP	6.35	4.1	50	12	10
25IP	6.35	4.6	50	12	10
27IP	6.35	5.2	50	13	10
30IP	6.35	5.7	50	13	10
40IP	6.35	-	50	14	10

121T-70 (IP)	D (mm)	R (mm)	L (mm)	(g)	(pcs.)
20IP	6.35	4.1	70	16	10
25IP	6.35	4.6	70	16	10
27IP	6.35	5.2	70	17	10
30IP	6.35	5.7	70	17	10
40IP	6.35	-	70	18	10

	Pin/O-Ring	D ₁ (mm)	D ₂ (mm)	L (mm)	(g)	(pcs.)	
12137E	1/4"	12	13	36	22	10	*1
13137E	3/8"	12	19	40	40	10	*2
14137E	1/2"	12	25	48	70	10	*3

*1 Pin/O-Ring=A21/B21

*2 C-Ring=C31, Pin/O-Ring=A31/B31

*3 C-Ring=C41, Pin/O-Ring=A41/B41

12137E, 13137E and 14147E can be used with various 1/4" bits, DIN 3126-C6.3, DIN 3126-E6.3 and Double ended type.

Die neuen Bithalter können für alle 1/4" Bits DIN 3126-C6.3, DIN 3126-E6.3 und für doppelseitige Bits verwendet werden.

Ces nouveaux porte embouts peuvent être utilisés avec tous les embouts 1/4" DIN 3126 E-6.3 et DIN 3126 C6.3

	Pin/O-Ring	D ₁ (mm)	D ₂ (mm)	L (mm)	(g)	(pcs.)	
12142-F6.3	1/4"	16.5	13	40	22	10	*1
13142-F6.3	3/8"	16.5	19	45	60	10	*2
14142-F6.3	1/2"	16.5	25	55	100	10	*3

*1 Pin/O-Ring=A21/B21

*2 C-Ring=C31, Pin/O-Ring=A31/B31

*3 C-Ring=C41, Pin/O-Ring=A41/B41

For DIN3126 E6.3 Bits
Für DIN3126 E6.3 Bits
Pour DIN3126 E6.3 Embouts

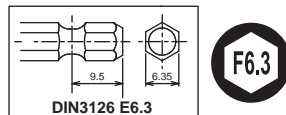

Lock & Quick Release

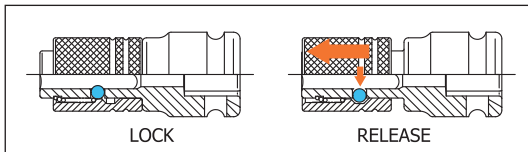

⚠ You may not hold the sliding part while moving to avoid heating up by friction and reduction by wear.

Bitte das gleitende Teil während der Bewegung nicht festhalten, um eine Erhitzung durch Reibung und durch Verschleiß zu vermeiden.

Vous ne devez pas tenir la partie coulissante pendant le déplacement afin d'éviter l'échauffement par frottement et la réduction par usure la réduction par l'usure.

121T-70 / -100 (TH)

⚠ Tamper-Resistant TORX® Bits
Tamper-Resistant TORX® Bits
Embouts TORX®, Tamper-Resistant

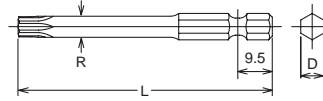

Tamper resistant TORX® Bits have less strength due to special design. Make sure to use it correctly.

Die manipulations-sicheren TORX®-Bits haben aufgrund ihres speziellen Designs eine geringere Festigkeit. Achten Sie darauf, sie richtig zu verwenden.

Les embouts TORX® à l'abri de manipulations sont moins résistants en raison de leur conception spéciale. Veuillez les utiliser correctement.

121T-50 / -70 (IP)

TORXPLUS® Bits
TORXPLUS® Bits
Embouts TORXPLUS®

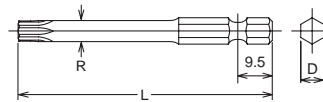

12137E

13137E

14137E

Impact Bit Holder
Impact Klingenhälter
Porte embouts Impact

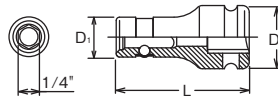

12142-F6.3

13142-F6.3

14142-F6.3

Impact Bit Holder (Quick Release)
Impact Klingenhälter (Quick Release)
Porte embouts Impact (Quick Release)

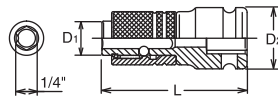

123PT-75 / -100

⊕ Double ended Torsion Bits, PH
Doppelseitige Torsionsbits, PH
Emboutis torsion double face, PH

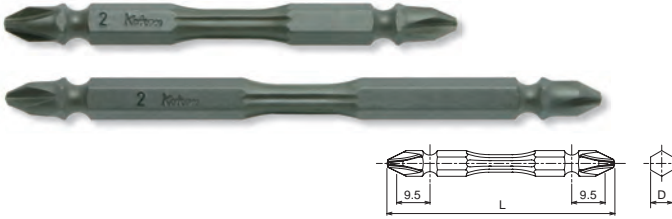

123PN-75 / -100

⊕ Double ended Bits, PH
Doppelseitige bits, PH
Emboutis double face, PH

123PG-75 / -100

⊕ Magnetic type
Magnetically
Type magnétique

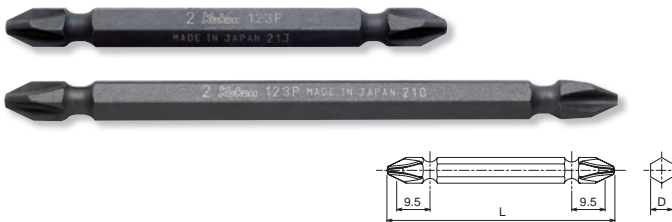

165LM

Ⓜ Slide Socket with Magnet
Gleitsteckschlüssel mit Magnet
Clé à douille coulissante avec aimant

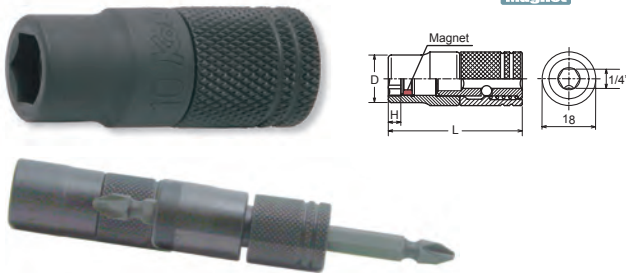

Nut Setter

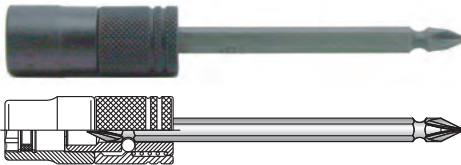

Phillips Bit

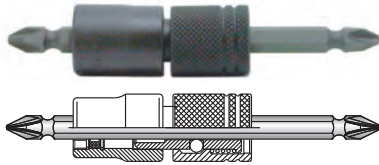

165BM

Ⓜ Double-sided socket with side magnets
Doppelseitiger Schiebsteckschlüssel mit Seitenmagneten
Clé à douille double face, coulissante avec aimants latéraux

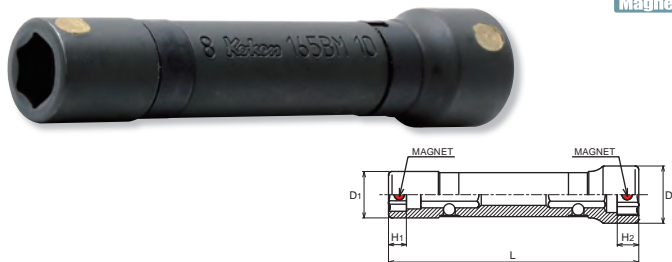

123PT (PH)	D (mm)	L (mm)	(g)	(pcs.)
2	6.35	75	18	10
2	6.35	100	24	10

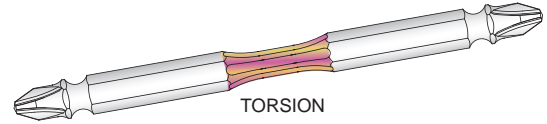

123PN-75 123PG-75 (PH)	D (mm)	L (mm)	(g)	(pcs.)
1	6.35	75	16	10
2	6.35	75	16	10
3	6.35	75	17	10

123PN-100 123PG-100 (PH)	D (mm)	L (mm)	(g)	(pcs.)
1	6.35	100	23	10
2	6.35	100	23	10
3	6.35	100	24	10

165LM-45 (mm)	D (mm)	H (mm)	L (mm)	(g)	(pcs.)
8	13.5	3.5	45	55	10
10	16	4.2	45	58	10
12	18.5	5.6	45	65	10
13	20	6	45	68	10
14	21	6.4	45	70	10

Slide the socket by pulling holder, and pull back the socket to lock on the bit groove. Ring magnet holds a bolt or nut for easy work.

Schieben Sie den Gleitsteckschlüssel durch Ziehen an der Hülse des Halters. Ziehen Sie das Werkzeug soweit zurück bis es sich in der Nut des Bits verriegelt. Zur Arbeitserleichterung hält der Ringmagnet die Schraube bzw. die Mutter.

Poussez la clé à douille coulissante en tirant sur le support. Tirez l'outil vers l'arrière jusqu'à ce qu'il s'enclenche dans rainure de la mèche. L'aimant maintient la vis ou l'écrou pour faciliter le travail.

⚠ You may not hold the sliding part while moving to avoid heating up by friction and reduction by wear.

Sie dürfen das Gleiteil nicht während der Bewegung halten, um Erwärmung durch Reibung und unnötigen Verschleiß zu vermeiden.

Ne pas tenir la partie coulissante pendant le mouvement pour éviter l'échauffement du au frottement et à l'usure inutile.

⚠ Please handle with care. The magnet could be broken with any impacts.

Der Magnet kann durch Stöße beschädigt werden. Bitte gehen Sie vorsichtig vor.

L'aimant peut être endommagé par des chocs importants. Veuillez procéder avec précaution.

165BM-70 (mm)	D ₁ (mm)	D ₂ (mm)	H ₁ (mm)	H ₂ (mm)	L (mm)	(g)	(pcs.)
8x10	13	16	5	6	70	55	10

165BM-80 (mm)	D ₁ (mm)	D ₂ (mm)	H ₁ (mm)	H ₂ (mm)	L (mm)	(g)	(pcs.)
10x12	16	19.1	6	8	80	80	10
10x13	16	20.5	8	8	80	80	10

165BM-100 (mm)	D ₁ (mm)	D ₂ (mm)	H ₁ (mm)	H ₂ (mm)	L (mm)	(g)	(pcs.)
10x12	16	19.1	8	8	100	95	10
10x14	16	21.5	8	10	100	105	10
12x14	19.1	21.5	8	10	100	130	10

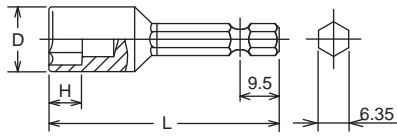

113-50 (mm)	D (mm)	H (mm)	L (mm)	(g)	(pcs.)
5.5	9	4	50	15	10
6	10	5	50	17	10
7	11	5	50	19	10
8	12	6	50	20	10
10	14.2	7	50	31	10
11	16	8	50	28	10
12	17	8	50	39	10
13	18	8	50	42	10
14	19	9	50	46	10

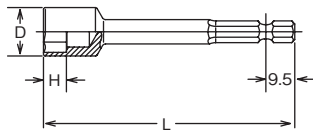

113-75 (mm)	D (mm)	H (mm)	L (mm)	(g)	(pcs.)
7	11.5	5	75	31	10
8	12.7	6	75	32	10
10	14.5	7	75	35	10
12	17	8	75	42	10
13	18	8	75	41	10
14	19	9	75	43	10

113-150 (mm)	D (mm)	H (mm)	L (mm)	(g)	(pcs.)
7	11.5	5	150	59	10
8	12.7	6	150	60	10
10	14.5	7	150	64	10
12	17	8	150	70	10
13	18	8	150	76	10
14	19	9	150	78	10

113-250 (mm)	D (mm)	H (mm)	L (mm)	(g)	(pcs.)
7	11.5	5	250	99	10
8	12.7	6	250	100	10
10	14.5	7	250	105	10
12	17	8	250	113	10
13	18	8	250	114	10
14	19	9	250	119	10

113-50 (E)	D (mm)	H (mm)	L (mm)	(g)	(pcs.)
E 4	6.1	4.5	50	12	10
E 5	7.5	4.5	50	15	10
E 6	8.3	5.0	50	17	10
E 7	8.8	5.8	50	18	10
E 8	10.1	6.6	50	19	10
E10	12	7.4	50	20	10

113-50 (mm)	D (mm)	H (mm)	L (mm)	(g)	(pcs.)
7(2B)	11	5	50	20	10
8(2B)	12	6	50	21	10
10(2B)	14.2	7	50	26	10
13(2B)	18	8	50	31	10

113-50 (inch)	D (mm)	H (mm)	L (mm)	(g)	(pcs.)
3/8(2B)	14.2	7	50	26	10



113-50

Nut Setters
Steckschlüssel Klingen
Embouts pour écrous



113-50 (inch)	D (mm)	H (mm)	L (mm)	(g)	(pcs.)
1/4	10	5	50	17	10
5/16	12	6	50	20	10
3/8	14.2	7	50	31	10
1/2	18	8	50	42	10

113-75 / -100 / -150 / -200 / -250

Nut Setters
Steckschlüssel Klingen
Embouts pour écrous



113-100 (mm)	D (mm)	H (mm)	L (mm)	(g)	(pcs.)
7	11.5	5	100	40	10
8	12.7	6	100	41	10
10	14.5	7	100	45	10
12	17	8	100	52	10
13	18	8	100	51	10
14	19	9	100	53	10

113-200 (mm)	D (mm)	H (mm)	L (mm)	(g)	(pcs.)
7	11.5	5	200	78	10
8	12.7	6	200	79	10
10	14.5	7	200	83	10
12	17	8	200	91	10
13	18	8	200	93	10
14	19	9	200	95	10

113-50 (E)

Nut Setters, TORX®
Steckschlüssel Klingen, TORX®
Embouts pour écrous, TORX®

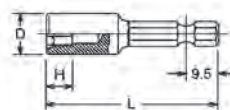

113-50 (2B)

Nut Setters, with 2 Balls
Steckschlüssel Klingen, mit 2-facher Kugelhalterung
Douilles à billes de retenue
Nut Grip®

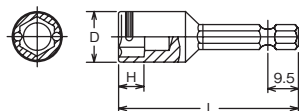

Z-SERIES
HAND
TITANIUM
ACCESSORIES
SCREWDRIVERS
IMPACT
SLEEVE-DRIVE
PROTECTOR
INDUSTRIAL
AUTOMOTIVE
MOTORCYCLE
CONSTRUCTION
SPARE PART

115-50



Nut Setters with Magnet
Steckschlüssel Klingen mit Magnet
Embouts avec aimant pour écrous

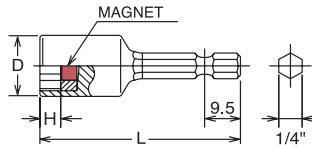

115-50 (mm)	D (mm)	H (mm)	L (mm)	(g)	(pcs.)
5.5	9	2.1	50	15	10
6	10	2.4	50	17	10
7	11	2.8	50	19	10
8	12	3.5	50	20	10
10	14.2	4.2	50	29	10
11	16	4.9	50	35	10
12	17	5.6	50	40	10
13	18	6	50	50	10
14	19	6.4	50	60	10

115-50 (inch)	D (mm)	H (mm)	L (mm)	(g)	(pcs.)
1/4	10	2.4	50	17	10
5/16	12	3.5	50	20	10
3/8	14.2	4.2	50	29	10
1/2	18	6	50	50	10

PK115/7

Nut Setters with Magnet, 7 pcs set in plastic case
Steckschlüsselklingen mit Magnet, 7teiliger Satz in Kunststoffkassette
Lames de clé à douille avec aimant, jeu de 7 pièces en cassette plastique



New PK115/7

7 Pieces Set/310g

PLASTIC CASE:W120xH115xT40mm

Nut Setters

MG 115-50 Nut Setter with Magnet
1/4, 3/8, 7, 8, 10, 12, 13

115-75 / -100 / -150 / -200 / -250



Nut Setters with Magnet
Steckschlüssel Klingen mit Magnet
Embouts avec aimant pour écrous

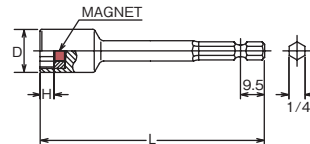

115-75 (mm)	D (mm)	H (mm)	L (mm)	(g)	(pcs.)
7	11.5	2.8	75	32	10
8	12.7	3.5	75	33	10
10	14.5	4.2	75	38	10
12	17	5.6	75	46	10
13	18	6	75	49	10
14	19	6.4	75	52	10

115-150 (mm)	D (mm)	H (mm)	L (mm)	(g)	(pcs.)
7	11.5	2.8	150	60	10
8	12.7	3.5	150	61	10
10	14.5	4.2	150	68	10
12	17	5.6	150	77	10
13	18	6	150	82	10
14	19	6.4	150	85	10

115-250 (mm)	D (mm)	H (mm)	L (mm)	(g)	(pcs.)
7	11.5	2.8	250	101	10
8	12.7	3.5	250	103	10
10	14.5	4.2	250	110	10
12	17	5.6	250	118	10
13	18	6	250	122	10
14	19	6.4	250	124	10

115-100 (mm)	D (mm)	H (mm)	L (mm)	(g)	(pcs.)
7	11.5	2.8	100	41	10
8	12.7	3.5	100	42	10
10	14.5	4.2	100	50	10
12	17	5.6	100	58	10
13	18	6	100	62	10
14	19	6.4	100	65	10

115-200 (mm)	D (mm)	H (mm)	L (mm)	(g)	(pcs.)
7	11.5	2.8	200	79	10
8	12.7	3.5	200	80	10
10	14.5	4.2	200	88	10
12	17	5.6	200	97	10
13	18	6	200	102	10
14	19	6.4	200	105	10

113UN-100 (mm)	D (mm)	H (mm)	L (mm)	(g)	(pcs.)
8	13	7	100	50	10
10	15	8	100	53	10
12	17	10	100	56	10
13	18	10	100	65	10
14	19.2	10	100	67	10

113UN-150 (mm)	D (mm)	H (mm)	L (mm)	(g)	(pcs.)
8	13	7	150	65	10
10	15	8	150	70	10
12	17	10	150	77	10
13	18	10	150	92	10
14	19.2	10	150	92	10

113UN-200 (mm)	D (mm)	H (mm)	L (mm)	(g)	(pcs.)
8	13	7	200	75	10
10	15	8	200	87	10
12	17	10	200	98	10
13	18	10	200	116	10
14	19.2	10	200	116	10

113UN-100 / -150 / -200

6-point Universal Joint Nut Setters
6-kant Steckschlüsselklingen mit Gelenk
Douilles 6-pans articulées à embout

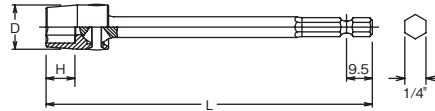

115G-75 / -100 / -150 / -200 / -250 / -300

Nut Setters with sliding Magnet
Steckschlüssel Klingen mit versenkbarem Magnet
Embout avec aimant, glissant pour écrous



115G-75 (mm)	D (mm)	H ₁ (mm)	H ₂ (mm)	L (mm)	(g)	(pcs.)
7	11.5	3.5	26	75	34	10
8	12.7	4	26	75	41	10
10	14.5	4.5	26	75	48	10
12	17	6	26	75	65	10
13	18	6.5	25	75	70	10
14	19	7	24	75	73	10

115G-100 (mm)	D (mm)	H ₁ (mm)	H ₂ (mm)	L (mm)	(g)	(pcs.)
7	11.5	3.5	26	100	51	10
8	12.7	4	26	100	51	10
10	14.5	4.5	26	100	57	10
12	17	6	26	100	77	10
13	18	6.5	25	100	80	10
14	19	7	24	100	82	10

115G-150 (mm)	D (mm)	H ₁ (mm)	H ₂ (mm)	L (mm)	(g)	(pcs.)
7	11.5	3.5	26	150	67	10
8	12.7	4	26	150	70	10
10	14.5	4.5	26	150	77	10
12	17	6	26	150	95	10
13	18	6.5	25	150	100	10
14	19	7	24	150	105	10

115G-200 (mm)	D (mm)	H ₁ (mm)	H ₂ (mm)	L (mm)	(g)	(pcs.)
7	11.5	3.5	26	200	86	10
8	12.7	4	26	200	89	10
10	14.5	4.5	26	200	96	10
12	17	6	26	200	119	10
13	18	6.5	25	200	125	10
14	19	7	24	200	128	10

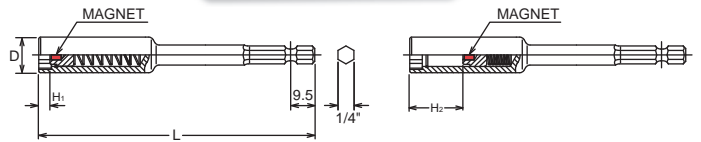
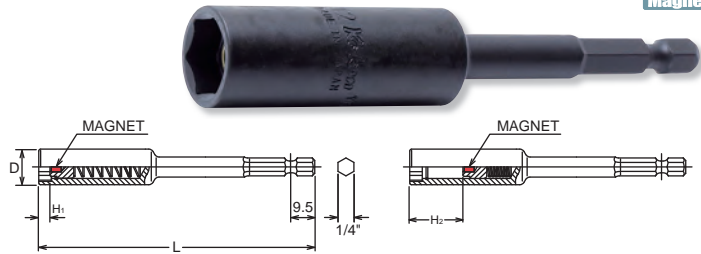

115G-250 (mm)	D (mm)	H ₁ (mm)	H ₂ (mm)	L (mm)	(g)	(pcs.)
8	12.7	4	26	250	110	10
10	14.5	4.5	26	250	120	10
12	17	6	26	250	130	10
13	18	6.5	25	250	150	10

115G-300 (mm)	D (mm)	H ₁ (mm)	H ₂ (mm)	L (mm)	(g)	(pcs.)
10	14.5	4.5	26	300	140	10
12	17	6	26	300	155	10

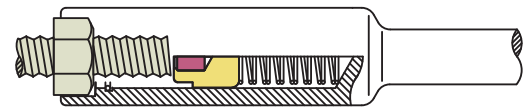

Sliding magnet system provides bolt clearance and magnetic function at the same time. The item 115G is mainly designed for assembly line work.

Die Steckschlüsselklinge mit versenkbarem Magnet bietet die Funktion eines Haltemagneten und genügend Freiraum für überstehende Bolzen. Dieses Werkzeug eignet sich vor allem für Montagearbeiten.

L'embout avec aimant glissant offre une fonction d'aimant et laisse assez d'espace pour des goujons surmontés. L'objet 115G a été conçu spécialement pour le travail d'assemblage.

119 (mm)	D (mm)	H (mm)	L (mm)	(g)	(pcs.)
5.5	9	2.1	50	17	10
6	10	2.4	50	20	10
7	11	2.8	50	22	10
8	12	3.5	50	23	10
10	14.2	4.2	50	30	10
12	17	5.6	50	42	10
13	18	6	50	52	10

119 (inch)	D (mm)	H (mm)	L (mm)	(g)	(pcs.)
1/4	10	1.8	50	20	10
5/16	12	3.5	50	23	10
3/8	14.2	4.2	50	30	10

119

Nut Setters with Magnet
Steckschlüssel Klingen mit Magnet
Embout avec aimant pour écrous

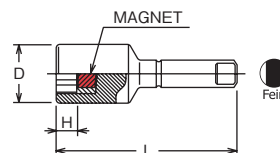

Z-SERIES
HAND
TITANIUM
ACCESSORIES
SCREWDRIVERS
IMPACT
SLEEVE-DRIVE
PROTECTOR
INDUSTRIAL
AUTOMOTIVE
MOTORCYCLE
CONSTRUCTION
SPARE PART

183H-35 / -75 / -150

Hex Bits
Sechskant Bits
Embouts, 6 pans creux

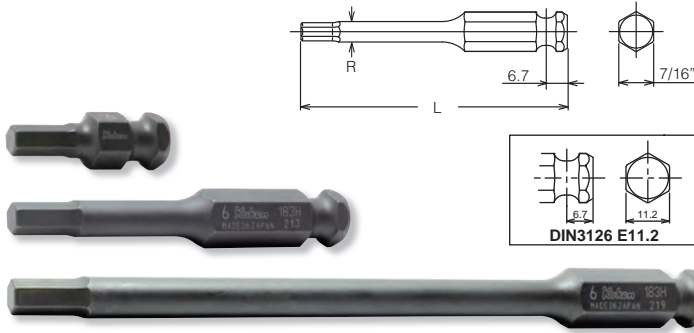

183H-35 (mm)	L (mm)	(g)	(pcs.)
3	35	15	10
4	35	15	10
5	35	15	10
6	35	18	10
7	35	19	10
8	35	20	10
9	35	23	10
10	35	26	10
11	35	28	10
12	35	30	10
14	35	35	10
16	35	47	10
17	35	50	10
18	35	53	10
19	35	56	10

183H-35 (inch)	L (mm)	(g)	(pcs.)
3/16	35	15	10
7/32	35	16	10
1/4	35	18	10
5/16	35	20	10
3/8	35	26	10
7/16	35	28	10
1/2	35	38	10

183H-75 (mm)	L (mm)	R (mm)	(g)	(pcs.)
3	75	6	34	10
4	75	6	35	10
5	75	6.5	36	10
6	75	7.5	39	10
7	75	8.5	44	10
8	75	9.5	47	10
10	75	-	57	10
11	75	-	60	10
12	75	-	65	10
14	75	-	79	10

183H-150 (mm)	L (mm)	R (mm)	(g)	(pcs.)
4	150	6	51	10
5	150	6.5	55	10
6	150	7.5	65	10
8	150	9.5	87	10
10	150	-	118	10
12	150	-	136	10

183H-75B / -150B

Ball-point Hex Bits
Sechskant Bits mit Kugelkopf
Embouts hexagonaux à tête sphérique

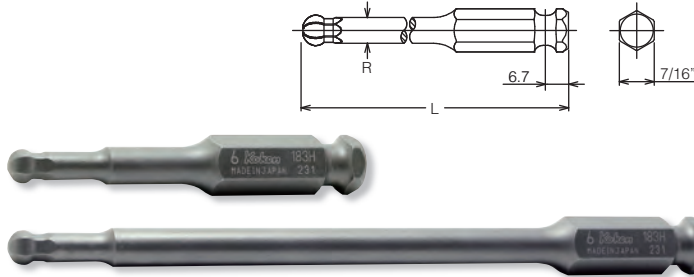

183H-75B (mm)	L (mm)	R (mm)	(g)	(pcs.)
6B	75	5.7	39	10
8B	75	7.7	44	10
10B	75	9.7	49	10
12B	75	11.7	72	10

183H-150B (mm)	L (mm)	R (mm)	(g)	(pcs.)
6B	150	5.7	65	10
8B	150	7.7	71	10
10B	150	9.7	92	10
12B	150	11.7	135	10

183T-35 / -75 / -150 (T)

TORX® Bits
TORX® Bits
Embouts, TORX®

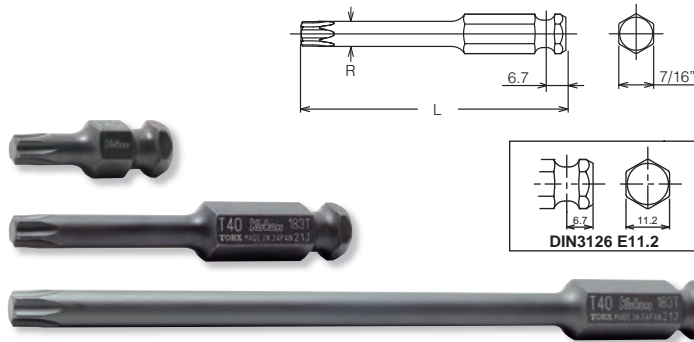

183T-35 (T)	L (mm)	(g)	(pcs.)
T25	35	18	10
T30	35	18	10
T40	35	20	10
T45	35	22	10
T50	35	26	10
T55	35	30	10
T60	35	38	10

183T-75 (T)	L (mm)	R (mm)	(g)	(pcs.)
T25	75	6	33	10
T27	75	6	33	10
T30	75	6	35	10
T40	75	6.9	37	10
T45	75	8	41	10
T50	75	9	45	10
T55	75	11.4	55	10
T60	75	13.5	67	10

183T-150 (T)	L (mm)	R (mm)	(g)	(pcs.)
T30	150	6	50	10
T40	150	6.9	58	10
T45	150	8	70	10
T50	150	9	82	10
T55	150	11.4	113	10
T60	150	13.5	148	10

⚠ The items with ⚠ have larger output sizes than 7/16" Input drive. Due to this design the maximum output torque rating is less than standard.

Die mit ⚠ gekennzeichneten Artikel haben größere Abtriebsgrößen als der 7/16" Antrieb. Aufgrund dieser Konstruktion ist das maximale Abtriebsdrehmoment geringer als der Standardwert.

Les articles marqués d'un ⚠ ont des tailles de sortie plus importantes que l'entraînement d'entrée 7/16". En raison de cette conception, le couple de sortie maximum est inférieur au couple standard.

183T-35 (IP)	L (mm)	(g)	(pcs.)
30IP	35	18	10
40IP	35	20	10
45IP	35	22	10
50IP	35	26	10
55IP	35	30	10
60IP	35	38	10

183T-75 (IP)	L (mm)	R (mm)	(g)	(pcs.)
30IP	75	6	35	10
40IP	75	6.8	37	10
45IP	75	8	41	10
50IP	75	9	45	10
55IP	75	11.4	56	10
60IP	75	13.5	67	10

183X-35 (XZN)	L (mm)	(g)	(pcs.)
M 4	35	18	10
M 5	35	18	10
M 6	35	20	10
M 8	35	22	10
M10	35	26	10
M12	35	30	10
M14	35	38	10

183X-75 (XZN)	L (mm)	R (mm)	(g)	(pcs.)
M 4	75	6	34	10
M 5	75	6	34	10
M 6	75	6.2	36	10
M 8	75	7.4	39	10
M10	75	9.8	54	10
M12	75	11.7	57	10
M14	75	13.5	67	10

183X-150 (XZN)	L (mm)	R (mm)	(g)	(pcs.)
M 5	150	6	50	10
M 6	150	6.2	53	10
M 8	150	7.4	64	10
M10	150	9.8	93	10
M12	150	11.7	121	10
M14	150	13.5	151	10

183T-35 / -75 (IP)

TORXPLUS® Bits
TORXPLUS® Bits
Embouts TORXPLUS®

TORXplus

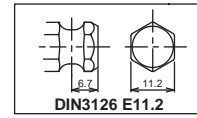
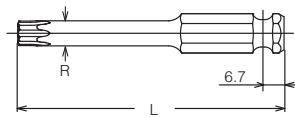

DIN3126 E11.2



183X-35 / -75 / -150 (XZN)

XZN Bits
XZN Bits
Embouts, XZN

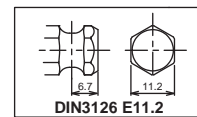
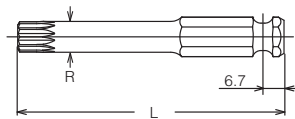

DIN3126 E11.2

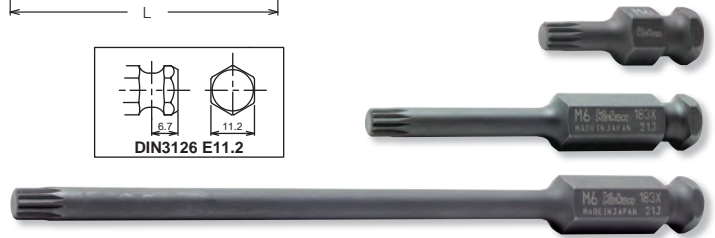

The items with have larger output sizes than 7/16" Input drive.
Due to this design the maximum output torque rating is less than standard.

Die mit gekennzeichneten Artikel haben größere Abtriebsgrößen als der 7/16" Antrieb.
Aufgrund dieser Konstruktion ist das maximale Abtriebsdrehmoment geringer als der Standardwert.

Les articles marqués d'un ont des tailles de sortie plus importantes que l'entraînement d'entrée 7/16".
En raison de cette conception, le couple de sortie maximum est inférieur au couple standard.

	□	D ₁ (mm)	D ₂ (mm)	L (mm)	(g)	(pcs.)	⊕
13134	3/8"	24	22	32	70	10	*1
14134	1/2"	24	25	38	90	10	*2
16134	3/4"	24	44	52	200	2	*3

*1 C-Ring=C32,Pin/O-Ring=A32/B32

*2 C-Ring=C41,Pin/O-Ring=A41/B41

*3 C-Ring=C61,Pin/O-Ring=A61/B61

For DIN3126 E11.2 Bits
Für DIN3126 E11.2 Bits
Pour DIN3126 E11.2 Embouts

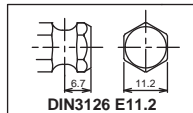

DIN3126 E11.2



13134 14134 16134

Impact Bit Holder
Impact Klingenhalter
Porte embouts Impact

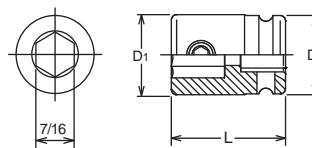

16134-SC

Replacement Screw : M8x6, ● 4mm
Ersatzschraube : M8x6, ● 4mm
Vis de remplacement : M8x6, ● 4mm

	□	D ₁ (mm)	D ₂ (mm)	L (mm)	(g)	(pcs.)	⊕
13142-F11.2	3/8"	18.9	22	46	116	10	*1
14142-F11.2	1/2"	18.9	25	46	207	10	*2

*1 C-Ring=C32,Pin/O-Ring=A32/B32

*2 C-Ring=C41,Pin/O-Ring=A41/B41

For DIN3126 E11.2 Bits
Für DIN3126 E11.2 Bits
Pour DIN3126 E11.2 Embouts

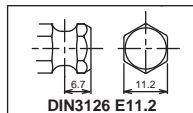

DIN3126 E11.2



13142-F11.2 14142-F11.2

Impact Bit Holder (Quick Release)
Impact Klingenhalter (Quick Release)
Porte embouts Impact (Quick Release)

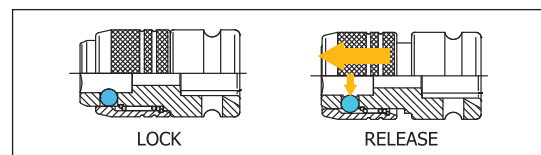
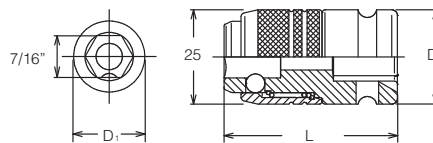

Adaptors with male Square
 Verbindungsteile mit Aussenvierkant
 Adaptateurs avec carré mâle

Z-SERIES
 HAND
 TITANIUM
 ACCESSORIES
 SCREWDRIVERS
 IMPACT
 SLEEVE-DRIVE
 PROTECTOR
 INDUSTRIAL
 AUTOMOTIVE
 MOTORCYCLE
 CONSTRUCTION
 SPARE PART

110-35B / -50B / -75B / -100B / -150B / -200B
-35P / -50P / -75P / -100P / -150P / -200P

Adaptors
 Verbindungsstücke
 Adaptateurs

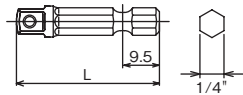

110	□	TYPE	L (mm)	(g)	(pcs.)
35B	1/4"	Ball	35	9	10
35P		Pin	35	9	10
50B		Ball	50	15	10
50P		Pin	50	15	10
New 75B		Ball	75	25	10
New 75P		Pin	75	25	10
100B		Ball	100	34	10
100P		Pin	100	34	10
150B		Ball	150	54	10
150P		Pin	150	54	10
New 200B		Ball	200	73	10
New 200P		Pin	200	73	10

DIN 3126 Form E 6.3

110AL-62 / -100 / -150 / -200

Adaptor (Quick Release)
 Schnellwechsel-Verbindungsstück
 Adaptateur autoserrant

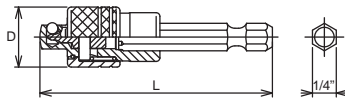

110AL	□	D (mm)	L (mm)	(g)	(pcs.)
New 62	1/4"	16.2	62	37	10
New 100		16.2	100	52	10
New 150		16.2	150	72	10
New 200		16.2	200	92	10

DIN 3126 Form E 6.3

You may not hold the sliding part while moving to avoid heating up by friction and reduction by wear.

Bitte das gleitende Teil während der Bewegung nicht festhalten, um eine Erhitzung durch Reibung und durch Verschleiß zu vermeiden.

Vous ne devez pas tenir la partie coulissante pendant le déplacement afin d'éviter l'échauffement par frottement et la réduction par usure.

112-50B / -75B / -100B / -150B / -200B
-50P / -75P / -100P / -150P / -200P

Adaptors
 Verbindungsstücke
 Adaptateurs

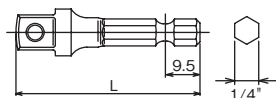



112	□	TYPE	L (mm)	(g)	(pcs.)
50B	3/8"	Ball	50	21	10
50P		Pin	50	21	10
New 75B		Ball	75	46	10
New 75P		Pin	75	46	10
100B		Ball	100	71	10
100P		Pin	100	71	10
150B		Ball	150	121	10
150P		Pin	150	121	10
New 200B		Ball	200	165	10
New 200P		Pin	200	165	10

DIN 3126 Form E 6.3



Adaptors with male Square
Verbindungsteile mit Aussenvierkant
Adaptateurs avec carré mâle

112AL  Adaptor (Quick Release)
Schnellwechsel-Verbindungsstück
Adaptateur autoserrant 

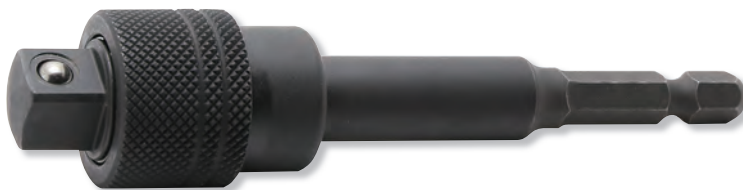
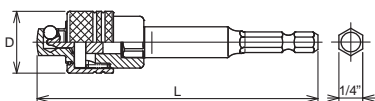

 You may not hold the sliding part while moving to avoid heating up by friction and reduction by wear.

Bitte das gleitende Teil während der Bewegung nicht festhalten, um eine Erhitzung durch Reibung und durch Verschleiß zu vermeiden.

Vous ne devez pas tenir la partie coulissante pendant le déplacement afin d'éviter l'échauffement par frottement et la réduction par usure la réduction par l'usure.

112AL		D (mm)	L (mm)	(g)	(pcs.)
New 100	$3/8"$	22	100	95	10



● DIN 3126 Form E 6.3

135E-60B / -60P  Adaptor
Verbindungsstück
Adaptateurs

135E		TYPE	L (mm)	(g)	(pcs.)
60B	$1/2"$	Ball	60	46	10
60P		Pin	60	46	10

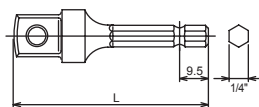
● DIN 3126 Form E 6.3



135AL  Adaptor (Quick Release)
Schnellwechsel-Verbindungsstück
Adaptateur autoserrant 

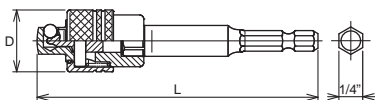

 You may not hold the sliding part while moving to avoid heating up by friction and reduction by wear.

Bitte das gleitende Teil während der Bewegung nicht festhalten, um eine Erhitzung durch Reibung und durch Verschleiß zu vermeiden.

Vous ne devez pas tenir la partie coulissante pendant le déplacement afin d'éviter l'échauffement par frottement et la réduction par usure la réduction par l'usure.

135AL		D (mm)	L (mm)	(g)	(pcs.)
New 100	$1/2"$	28	100	160	10

● DIN 3126 Form E 6.3

Adaptors with male Square
Verbindungssteile mit Aussenvierkant
Adaptateurs avec carré mâle

Z-SERIES
HAND
TITANIUM
ACCESSORIES
SCREWDRIVERS
IMPACT
SLEEVE-DRIVE
PROTECTOR
INDUSTRIAL
AUTOMOTIVE
MOTORCYCLE
CONSTRUCTION
SPARE PART

**117-50B / -100B
-50P / -100P**

Adaptors
Verbindungsstücke
Adaptateurs

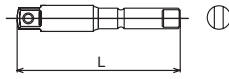

117		TYPE	L (mm)	(g)	(pcs.)
50B	1/4"	Ball	50	15	10
50P		Pin	50	15	10
100B		Ball	100	71	10
100P		Pin	100	71	10

DIN 3126 Form G7

120-50B / -50P

Adaptor
Verbindungsstück
Adaptateurs

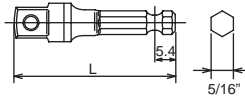

120		TYPE	L (mm)	(g)	(pcs.)
50B	3/8"	Ball	50	27	10
50P		Pin	50	27	10

DIN 3126 Form E 8

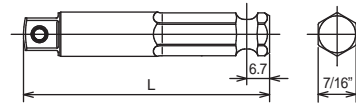

186-75P

Adaptor
Verbindungsstück
Adaptateurs



186		L (mm)	(g)	(pcs.)
75P	3/8"	75	65	10
75P	1/2"	75	85	10

DIN 3126 Form E 11.2

DIN3126 ISO1173 Bits	C6.3		C8		E6.3		E8		E11.2		G7	
	No.	Page	No.	Page	No.	Page	No.	Page	No.	Page	No.	Page
PH	108P series	166	100P series	168	121P series 123P series	170/172						
PZ			100P(PZ) series	168								
Slotted	108S series	166	100S series	168								
HEX	108H series	166	100H series	168	121H series	170			183H series	176		
HEX (Ball point)									183H-B series	176		
TORX® (T)	108T(T) series	166	100T(T) series	168	121T(T) series	170			183T(T) series	176		
TORX® (TH)	108T(TH) series	166	100T(TH) series	169	121T(TH) series	171						
TORXplus® (IP)					121T(IP) series	171			183T(IP) series	177		
XZN			100X series	169					183X series	177		
6-point					113 series 113UN series	173/175						
MG (with Magnet)					115 series 115G series	174-175					119 series	175
TORX® (E)					113(E) series	173						
ADAPTOR	108A	166			110 series 112 series 135 series	178-179	120 series	180	186 series	180	117 series	180
BIT HOLDER	2137 3137 4137 12139 13139 14139 13142-D6.3 14142-D6.3 180M	167	2138 3138 4138 12140 13140 14140	169	12137E 13137E 14137E 13142-F6.3 14142-F6.3	171			13134 14134 16134 13142-F11.2 14142-F11.2	177		

**SCREWDRIVERS
SCHRAUBENDREHER
TOURNEVIS**



Screwdrivers
Schraubendreher
Tournevis

Z-SERIES
HAND
TITANIUM
ACCESSORIES
SCREWDRIVERS
IMPACT
SLEEVE-DRIVE
PROTECTOR
INDUSTRIAL
AUTOMOTIVE
MOTORCYCLE
CONSTRUCTION
SPARE PART

167M / 167A



Socket Drivers
Sechskant Steckschlüssel, mit Griff
Clé à douille avec manche

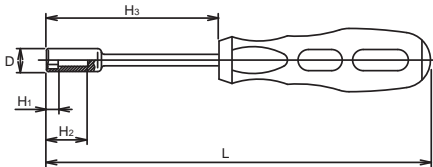

167M (mm)	D (mm)	H ₁ (mm)	H ₂ (mm)	H ₃ (mm)	L (mm)	(g)	(pcs.)
3	5.8	3	25	125	225	62	6
3.5	5.8	3	25	125	225	62	6
4	6.7	3.5	25	125	225	64	6
4.5	7.2	4.5	25	125	225	65	6
5	7.8	5	25	125	225	66	6
5.5	8.4	5.5	25	125	225	68	6
6	9.1	6	25	125	225	70	6
7	10.9	6.5	25	125	235	101	6
8	12	7	25	125	235	103	6
9	13.2	7.5	25	125	235	107	6
10	14.5	8	25	125	235	111	6
11	15.9	8.5	25	125	245	155	6
12	16.8	9	25	125	245	161	6
13	18.2	9.5	25	125	245	167	6
14	19.2	11	25	125	245	178	6

167A (inch)	D (mm)	H ₁ (mm)	H ₂ (mm)	H ₃ (mm)	L (mm)	(g)	(pcs.)
1/4	9.1	6	25	125	225	70	6

167C (2B)



Interchangeable Socket Driver, **Nut Grip**[®]
Universalgriff mit auswechselbaren **Nut Grip**[®] Steckschlüsselklingen
Clé à douille interchangeable avec manche **NUT Nut Grip**[®]

167C/3-2B



Set 3 pieces
Satz 3teilig
Jeu de 3 tournevis

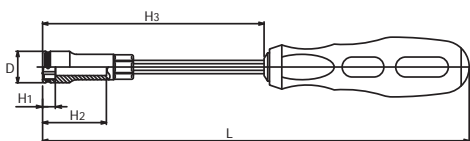

167C(2B) (mm)	D (mm)	H ₁ (mm)	H ₂ (mm)	H ₃ (mm)	L (mm)	(g)	(pcs.)
7(2B)	11.5	4	38	122	235	120	6
8(2B)	12.3	5	38	122	235	125	6
10(2B)	14.2	6	38	122	235	130	6
12(2B)	17.3	7	38	122	235	135	6

167C/3-2B	4 Pieces Set/△=280g
PLASTIC BAG	
Socket Drivers	
Socket:	7, 8, 10
Grip:	167C-GRIP

168H-B



Ball Point Hex Screwdrivers
Schraubendreher Innensechskant mit Kugelkopf
Tournevis avec tête sphérique pour vis 6-pans creux

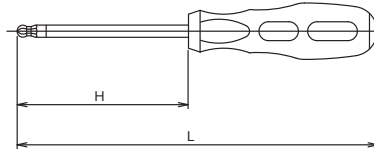

168H (mm)	H (mm)	L (mm)	(g)	(pcs.)
3B	80	150	25	6
4B	125	225	60	6
5B	125	235	85	6
6B	125	245	150	6
7B	125	245	151	6
8B	125	245	153	6

Ball point Hex Screwdrivers have less strength due to the special design. Make sure to use them correctly.

168T (TH)



Screwdriver for TORX® Tamper Resistant
TORX® Schraubendreher Tamper-Resistant
Tournevis pour vis TORX® tamper resistant

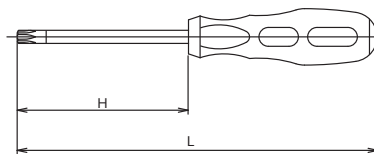

168T (TH)	H (mm)	L (mm)	(g)	(pcs.)
T10H	80	150	25	6
T15H	80	150	25	6
T20H	125	225	60	6
T25H	125	225	60	6
T27H	125	235	90	6
T30H	125	235	92	6
T40H	125	245	153	6

Tamper Resistant TORX® Screwdrivers have less strength due to the special design. Make sure to use it correctly.

168T/7-TH	(g)
168T-T10H, T15H, T20H, T25H, T27H, T30H, T40H	480



168T/7 (TH)



Set 7 pieces
Satz 7teilig
Jeu de 7 tournevis



168P (PZ)



Pozidriv Screwdrivers
Schraubendreher, Pozidriv
Tournevis pour vis Pozidriv

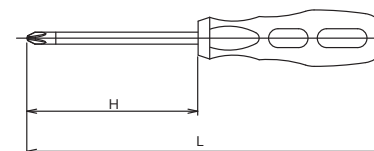



168P (PZ)	H (mm)	L (mm)	(g)	(pcs.)
PZ1	75	175	78	6
PZ2	100	210	129	6
PZ3	150	270	203	6

TORX is a registered trademark of CAMCAR Innovations.
TORX ist ein registriertes Markenzeichen der Firma CAMCAR Innovations.
TORX est une marque déposée de CAMCAR Innovations.

Screwdrivers
Schraubendreher
Tournevis

Z-SERIES
HAND
TITANIUM
ACCESSORIES
SCREWDRIVERS
IMPACT
SLEEVE-DRIVE
PROTECTOR
INDUSTRIAL
AUTOMOTIVE
MOTORCYCLE
CONSTRUCTION
SPARE PART

166P  Screwdriver PH (Blade-Through type)
Kreuzschlitz Schraubendreher PH mit durchgehender 6-kant Klinge
Tournevis cruciforme PH avec lame hexagonale traversante

166S  Slotted screwdriver (Blade-Through type)
Schlitz-Schraubendreher mit durchgehender 6-kant Klinge
Tournevis pour vis à fente avec lame hexagonale traversante

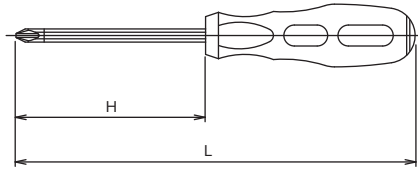
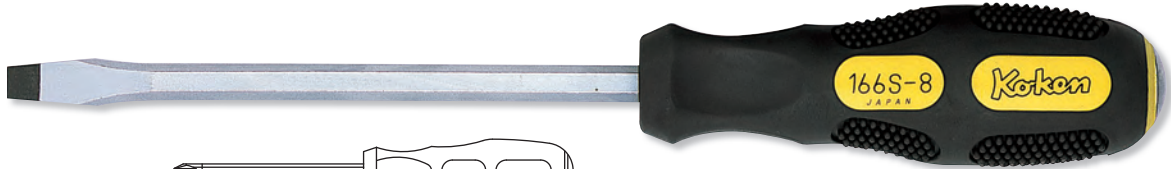

FLAT HAMMERING HEAD
FLACHES SCHLAGENDE
BATTEMENT PLAT

BLADE-THROUGH
DURCHGEHENDE KLINGE
EMBOUT EN CONTINU

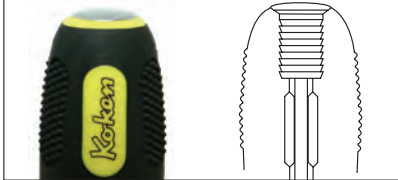

166P (PH)	H (mm)	L (mm)	(g)	(pcs.)
1	75	175	78	6
2	100	210	129	6
3	150	270	203	6



166S	H (mm)	L (mm)	(g)	(pcs.)
5	75	175	78	6
6	100	210	129	6
8	150	270	203	6

166PS/6   Set 6 pieces
Satz 6teilig
Jeu de 6 tournevis



166PS/6 6 Pieces Set/△=885g

CARDBOARD BOX:W280xH115xT40mm
Screwdrivers



-  **166P** Screwdrivers
1, 2, 3
-  **166S** Screwdrivers
5, 6, 8

PK166PS/6   Set 6 pieces in Plastic Box
Satz 6teilig in Plastikassette
Module plastique des 6 tournevis



PK166PS/6 6 Pieces Set/△=950g

PLASTIC TRAY
Screwdrivers

-  **166P** Screwdrivers
1, 2, 3
-  **166S** Screwdrivers
5, 6, 8

- 168P**  Screwdriver, PH
Schraubendreher, PH
Tournevis à zone de frappe, PH
- 168S**  Slotted Screwdriver
Schlitz-Schraubendreher
Tournevis pour vis à fente

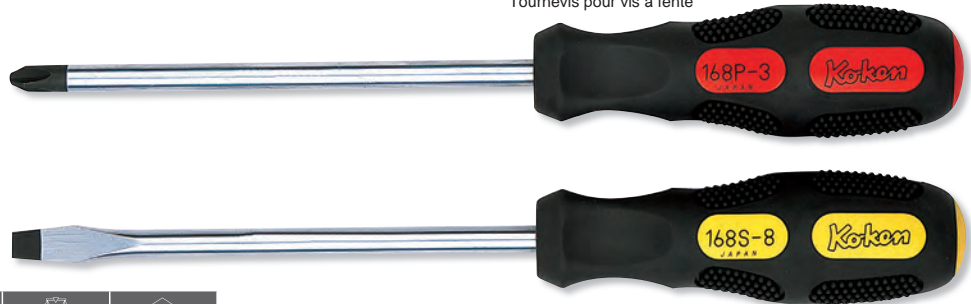
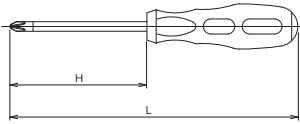

168P (PH)	H (mm)	L (mm)	(g)	(pcs.)
1	75	175	59	6
2	100	210	86	6
2(150)	150	260	100	6
2(200)	200	310	111	6
2(300)	300	410	133	1
3	150	270	150	6

168S	H (mm)	L (mm)	(g)	(pcs.)
5	75	175	59	6
6	100	210	86	6
6(150)	150	260	100	6
6(200)	200	310	111	6
6(300)	300	410	133	1
8	150	270	150	6

168PS/6 6 Pieces Set/△=660g

CARDBOARD BOX:W280xH115xT40mm

Screwdrivers

-  168P Screwdrivers
1, 2, 3

-  168S Screwdrivers
5, 6, 8

PK168PS/6 6 Pieces Set/△=720g

PLASTIC TRAY

Screwdrivers

-  168P Screwdrivers
1, 2, 3

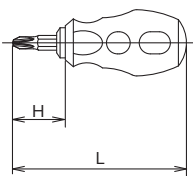

-  168S Screwdrivers
5, 6, 8



168CS	H (mm)	L (mm)	(g)	(pcs.)
2x6	22	86	46	6

- 168PS/6**   Set 6 pieces
Satz 6teilig
Jeu de 6 tournevis





- PK168PS/6**   Set 6 pieces in Plastic Box
Satz 6teilig in Plastikkassette
Module plastique des 6 tournevis



- 168CS**   Interchangeable Screwdriver, Stubby
Schraubendrehergriff für auswechselbare Klinge, kurz
Poignée porte-lames reversible, court



- 168C**   Interchangeable Screwdriver
Schraubendrehergriff für auswechselbare Klingen
Poignée porte-lames reversible

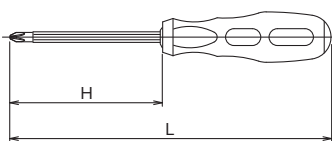

168C	H (mm)	L (mm)	(g)	(pcs.)
2x6	100	210	108	6
2x6(150)	150	260	120	6
2x6(200)	200	310	133	6

Z-SERIES
HAND
TITANIUM
ACCESSORIES
SCREWDRIVERS
IMPACT
SLEEVE-DRIVE
PROTECTOR
INDUSTRIAL
AUTOMOTIVE
MOTORCYCLE
CONSTRUCTION
SPARE PART

2769N-150 / -220 Spin Type Handle
Drehgriff
Poignée emmanchée

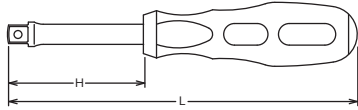

2769N		H (mm)	L (mm)	(g)	(pcs.)
150	1/4"	50	150	73	2
220		120	220	100	2



Plastic or rubber handles are not intended to act as insulation.

Plastik-oder Gummigriffe stellen keinen Isolierschutz dar.

Les poignées en plastique ou en caoutchouc ne garantissent aucune isolation électrique.

2769NWF-150 / -220 Spin Type Handle (Wobble-Fix)
Drehgriff, Wobble-Fix
Poignée emmanchée, angulaire

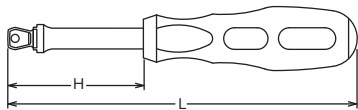

2769NWF		H (mm)	L (mm)	(g)	(pcs.)
150	1/4"	50	150	73	2
220		120	220	100	2

Wobble-Fix Extension Bar

Two way usage

- a) In a fixed position, as a normal extension bar
- b) In a half-fixed position, as a flexible extension bar providing a 15° angle operation

Winkel-Verlängerungen

Winkelverlängerungen lassen sich in zwei Einstellungen verwenden

- a) voll eingesteckt und starr,
- b) halb eingesteckt, mit einem Arbeitswinkel von 15°.

Rallonges angulaires

Deux utilisations possibles

- a) comme rallonge normale, dans une position fixe
- b) comme une rallonge angulaire avec une possibilité d'inclinaison jusqu'à 15°

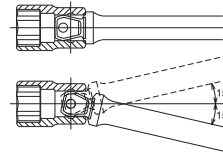

3769N-160 / -230 Spin Type Handle
Drehgriff
Poignée emmanchée

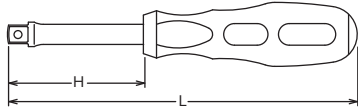

3769N		H (mm)	L (mm)	(g)	(pcs.)
160	3/8"	50	160	110	2
230		120	230	135	2

3769NWF-160 / -230 Spin Type Handle (Wobble-Fix)
Drehgriff, Wobble-Fix
Poignée emmanchée, angulaire

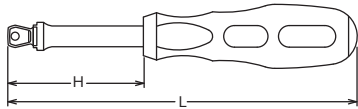

3769NWF		H (mm)	L (mm)	(g)	(pcs.)
160	3/8"	50	160	110	2
230		120	230	135	2

IMPACT

SOCKETS
STECKSCHLÜSSEL
DOUILLES

1/4"

3/8"

1/2"

5/8"

3/4"

1"

1-1/2"

2-1/2"

























































3-1/2"



Impact Sockets

Impact Steckschlüssel

Douilles Impact

Impact Sockets	Square Drive														
	1/4"(6.35mm)SQ.			3/8"(9.5mm)SQ.			1/2"(12.7mm)SQ.			5/8"(15.9mm)SQ.			3/4"(19mm)SQ.		
	No.	Page		No.	Page		No.	Page		No.	Page		No.	Page	
 Standard Sockets	 6-point	12400M mm 190	13400M mm 194	14400M mm 212	15400M mm 232	16400M mm 234									
	 6-point (Thin-walled)	12400A inch 190	13400A inch 194	14400A inch 212	15400A inch 232	16400A inch 234									
	 6-point (with Magnet)	12400MG mm 190	13400MG mm 196	14400MG mm 214											
	 12-point		13405M mm 194	14405M mm 212		16405M mm 234									
	 12-point (Thin-walled)		13405A inch 194	14405A inch 212		16405A inch 234									
	 Surface	12410M mm 190	13410M mm 196	14410M mm 214	15410M mm 232	16410M mm 235									
	 PATHFINDER®	12465M mm 191	13465M mm 197	14465M mm 215											
	 TORX® (E)	12425 TORX® 191	13425 TORX® 198	14425 TORX® 215		16425 TORX® 236									
	 TORXplus® (EP)		13425-EPL TORXplus® 198	14425-EPL TORXplus® 215		16425-EPL TORXplus® 236									
	 TORXplus® (EPR)		13425-EPRL TORXplus® 198												
	 LH-S		13401LH LH-STIX® 199	14401LH LH-STIX® 214											
	 for Self Tapping Screws	12460M mm 191	13460M mm 197												
	 for Self Tapping Screws (with Magnet)	12460MG mm 191	13460MG mm 197												
	 Double Square	12460A inch 191	13460A inch 197	14415M mm 215											
	 for Weld Nut		13400-WN 199	14400-WN 215											
 Short Sockets	 6-point (Thin-walled)		13401MS mm 196	14401MS mm 214											
 Semi Deep Sockets	 6-point (Thin-walled)		13301X mm 199	14301X mm 216	16301X mm 236										
	 6-point (with Slide Magnet)		13300XG mm 200												
 Deep Sockets	 6-point	12300M mm 192	13300M mm 200	14300M mm 216	15300M mm 233	16300M mm 237									
	 6-point (Thin-walled)		13300A inch 200	14300A inch 216		16300A inch 237									
	 6-point (Thin-walled)		13301M mm 200	14301M mm 217		16301M mm 238									
	 6-point (Thin-walled)		13301A inch 200	14301A inch 217		16301A inch 238									
	 6-point (with Slide Magnet)	12300G mm 192	13300G mm 201	14300G mm 218											
	 12-point		13305M mm 201	14305M mm 217		16305M mm 237									
	 12-point (Thin-walled)		13306M mm 201	14306M mm 217											
 Surface		13310M mm 201	14310M mm 218	15310M mm 233	16310M mm 238										
 PATHFINDER®	12365M mm 192	13365M mm 201	14365M mm 218												
 TORX® (E)		13325 TORX® 202	14325 TORX® 218		16325 TORX® 238										
 Extension Sockets	 6-point		13145M mm 203	14145M mm 220											
	 6-point (with Magnet)		13145MG mm 203	14145MG mm 220											
	 12-point		13145M(12P) mm 204												
 Universal Sockets	 6-point		13440M mm 202	14440M mm 219											
	 6-point (Extension)		13440A inch 202	14440A inch 219											
	 6-point (Extension)		13146M mm 204	14146M mm 221											
 TORX® (E)		13440T TORX® 202													
 Bit Sockets	 Hexagon		13012M mm 205	14012M mm 222											
	 TORX® (T)		13025 TORX® 205	14025 TORX® 222											
 Bit Sockets (Bit changeable)	 Hexagon		13134M mm 208	14134M mm 225	16106-16 mm 239										
	 TORX® (T)		13134T(T) TORX® 208	14134T(T) TORX® 225	16107-22 mm 241										
	 TORXplus® (IP)		13134T(IP) TORXplus® 208	14134T(IP) TORXplus® 225	16106-16(T) TORX® 239										
	 XZN (Triple Square)		13134X(XZN) XZN 208	14134X(XZN) XZN 225	16106-16(XZN) XZN 239										
 Universal Bit Sockets	 Hexagon		13430M mm 202												
	 Hexagon (Extension)		13147M mm 204	14147M mm 221											
 Extension Bars	12760 193	13760 210	14760 228		16760 241										
 Universal Joints	12770 193	13770 211	14770 229	15770 233	16770 242										
		13771 211	14771 229		16771 242										
		13772 211	14772 229												
 Adaptors	12233A 193	13322A 211	14433A 229	15544A 233	16644A 242										
		13344A 211	14455A 229	15566A 233	16655A 242										
		13333WA 210	14466A 229	15566A 233	16688A 242										
			14444WA 228												
 Locking Adaptors	12222AL 193	13333AL 210	14444AL 228	15555AL 233	16666AL 242										
			14466AL 228		16644AL 242										

Impact Sockets		Square Drive											
		1"(25.4mm)SQ.			1.1/2"(38.1mm)SQ.			2.1/2"(63.5mm)SQ.			3.1/2"(88.9mm)SQ.		
		No.	mm	Page	No.	mm	Page	No.	mm	Page	No.	mm	Page
Standard Sockets	6-point	18400M	mm	244	17400M	mm	254	19400M	mm	258	10400M	mm	260
	6-point (Thin-walled)	18400A	inch	244	17400A	inch	254	19400A	inch	258	10400A	inch	260
	6-point (with Magnet)	18401M	mm	245									
	6-point (with Magnet)	18401A	inch	245									
	12-point	18405M	mm	245	17405M	mm	255						
	12-point (Thin-walled)	18405A	inch	245	17405A	inch	255						
	Surface	18410M	mm	246									
	PATHFINDER®												
	TORX® (E)												
	TORXplus® (EP)												
	TORXplus® (EPR)												
	LH-S												
	for Self Tapping Screws												
	for Self Tapping Screws (with Magnet)												
	Double Square												
for Weld Nut													
Short Sockets	6-point (Thin-walled)												
Semi Deep Sockets	6-point (Thin-walled)	18301X	mm	247									
	6-point (with Slide Magnet)												
Deep Sockets	6-point	18300M	mm	247	17300M	mm	255	19300M	mm	259			
	6-point	18300A	inch	247	17300A	inch	255						
	6-point (Thin-walled)	18301M	mm	248									
	6-point (Thin-walled)	18301A	inch	248									
	6-point (with Slide Magnet)												
	12-point												
	12-point (Thin-walled)												
	Surface	18310M	mm	248									
Extension Sockets	PATHFINDER®												
	TORX® (E)												
	6-point	18104M	mm	248									
Universal Sockets	6-point (with Magnet)												
	12-point												
	6-point (Extension)												
Bit Sockets	TORX® (E)												
	Hexagon												
Bit Sockets (Bit changeable)	Hexagon	18106-16	mm	249	17108-32	mm	256						
	Hexagon	18107-22	mm	251									
	Hexagon	18108-32	mm	252									
	TORX® (T)	18106-16(T)	TORX®	249									
Universal Bit Sockets	TORXplus® (IP)												
	XZN (Triple Square)	18106-16(XZN)	XZN	249									
Extension Bars	Hexagon												
	Hexagon (Extension)												
Universal Joints	Extension Bars	18760		252	17760		257	19760		259			
	Universal Joints	18770		253	17770		257	19770		259			
Adaptors	Universal Joints	18771		253	17770		257	19770		259			
	Adaptors	18866A		253	17788A		257	19977A		259	10099A	260	
Locking Adaptors	Adaptors	18877A		253	17799A		257						
Locking Adaptors	Adaptors	18888AL		253									

Z-SERIES
HAND
TITANIUM
ACCESSORIES
SCREWDRIVERS
IMPACT
SLEEVE-DRIVE
PROTECTOR
INDUSTRIAL
AUTOMOTIVE
MOTORCYCLE
CONSTRUCTION
SPARE PART

Impact Sockets Impact Steckschlüssel Douilles Impact

1/4"

Z-SERIES
HAND
TITANIUM
SCREWDRIVERS ACCESSORIES
IMPACT
SLEEVE-DRIVE
PROTECTOR
INDUSTRIAL
AUTOMOTIVE
MOTORCYCLE
CONSTRUCTION
SPARE PART

12400M / 12400A

6-point Sockets
6-kant Steckschlüssel
Douilles 6-pans

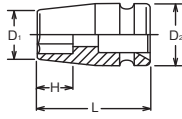

12400A (inch)	D ₁ (mm)	D ₂ (mm)	H (mm)	L (mm)	(g)	(pcs.)	
5/32	7.5	13	4	23	14	10	*1
3/16	8.1	13	4	23	14	10	*1
7/32	9.4	13	4	23	16	10	*1
1/4	10	13	5	23	14	10	*1
9/32	11.3	13	5	23	14	10	*1
5/16	12.5	13	6	23	14	10	*1
11/32	13.8	13	7	23	14	10	*1
3/8	15	13	7	23	15	10	*1
7/16	16.3	13	8	23	18	10	*1
1/2	18.8	13	8	23	19	10	*1
9/16	20	13	9	23	20	10	*1

*1 Pin/O-Ring=A21/B21 → P269

12400M (mm)	D ₁ (mm)	D ₂ (mm)	H (mm)	L (mm)	(g)	(pcs.)	
4	7.5	13	4	23	14	10	*1
4.5	8.1	13	4	23	14	10	*1
5	8.8	13	4	23	14	10	*1
5.5	9.4	13	4	23	14	10	*1
6	10	13	5	23	14	10	*1
7	11.3	13	5	23	14	10	*1
8	12.5	13	6	23	14	10	*1
9	13.8	13	7	23	14	10	*1
10	15	13	7	23	15	10	*1
11	16.3	13	8	23	18	10	*1
12	17.5	13	8	23	19	10	*1
13	18.8	13	8	23	19	10	*1
14	20	13	9	23	20	10	*1

*1 Pin/O-Ring=A21/B21 → P269

12400MG / 12400AG

6-point Sockets with Magnet
6-kant Steckschlüssel mit Magnet
Douilles 6-pans avec aimant

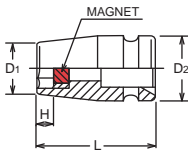

12400AG (inch)	D ₁ (mm)	D ₂ (mm)	H (mm)	L (mm)	(g)	(pcs.)	
3/16	8.1	13	2.1	23	13	10	*1
1/4	10	13	2.4	23	16	10	*1
5/16	12.5	13	3.5	23	17	10	*1
11/32	13.8	13	3.8	23	18	10	*1
3/8	15	13	4.2	23	18	10	*1
7/16	16.3	13	4.9	23	21	10	*1
1/2	18.8	13	6	25	21	10	*1
9/16	20	13	6.4	25	20	10	*1

*1 Pin/O-Ring=A21/B21 → P269

12400MG (mm)	D ₁ (mm)	D ₂ (mm)	H (mm)	L (mm)	(g)	(pcs.)	
4	7.5	13	2.1	23	12	10	*1
4.5	8.1	13	2.1	23	13	10	*1
5	8.8	13	2.1	23	15	10	*1
5.5	9.4	13	2.1	23	15	10	*1
6	10	13	2.4	23	16	10	*1
7	11.3	13	2.8	23	16	10	*1
8	12.5	13	3.5	23	17	10	*1
9	13.8	13	3.8	23	18	10	*1
10	15	13	4.2	23	18	10	*1
11	16.3	13	4.9	23	21	10	*1
12	17.5	13	5.6	25	21	10	*1
13	18.8	13	6	25	21	10	*1
14	20	13	6.4	25	20	10	*1

*1 Pin/O-Ring=A21/B21 → P269

12410M

Surface Drive Sockets
Surface Drive Steckschlüssel
Douilles, Surface Drive

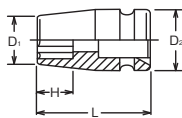

12410M (mm)	D ₁ (mm)	D ₂ (mm)	H (mm)	L (mm)	(g)	(pcs.)	
6	10	13	5	23	14	10	*1
7	11.3	13	5	23	15	10	*1
8	12.5	13	6	23	15	10	*1
9	13.8	13	7	23	14	10	*1
10	15	13	7	23	14	10	*1
11	16.3	13	8	23	17	10	*1
12	17.5	13	8	23	19	10	*1
13	18.8	13	8	23	19	10	*1

*1 Pin/O-Ring=A21/B21 → P269

SURFACE DRIVE

Surface drive sockets are designed to retain contact with the flat sides of the nut in order to transmit high torque and reduce nut wear. These sockets are ideal for using on polished nuts, aluminum nuts and nuts with worn out points.

Das Profil unserer Surface-Drive Steckschlüssel greift die Schraube an deren Flächen. Dies sichert eine höhere Kraftübertragung und verhindert ein Durchrutschen des Steckschlüssels. Diese Steckschlüssel eignen sich besonders für polierte Schrauben, Aluminium Schrauben und Schrauben bei denen die Ecken bereits abgerundet sind.

Notre profil Surface Drive assure le contact entre la douille et les plats de l'écrou. Ceci réduit l'usure et permet la transmission d'un couple plus élevé. C'est une solution idéale pour les écrous polies, celles en aluminium ou arrondies.

1/4"

Impact Sockets
Impact Steckschlüssel
Douilles Impact

Z-SERIES
HAND
TITANIUM
ACCESSORIES
SCREWDRIVERS
IMPACT
SLEEVE-DRIVE
PROTECTOR
INDUSTRIAL
AUTOMOTIVE
MOTORCYCLE
CONSTRUCTION
SPARE PART

12465M (mm)	D ₁ (mm)	D ₂ (mm)	H (mm)	L (mm)	(g)	(pcs.)	
10	15	13	8	23	17	10	*1
11	16.3	13	8	23	18	10	*1
12	17.5	13	9	23	18	10	*1
13	18.8	13	9	23	20	10	*1

*1 Pin/O-Ring=A21/B21 → P269



12465M Pathfinder Sockets
Pathfinder Steckschlüssel
Douilles Pathfinder

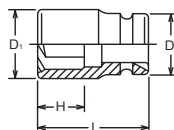

PATHFINDER®

The beveled flats of the 6-points opening of the PATHFINDER socket engage the nut almost immediately. PATHFINDER sockets are ideal for using with power tools in automatic assembly processes, as the power tool does not have to be totally stopped for the socket to engage the nut.

Da die Maschine nicht nach jedem Schraubvorgang angehalten werden muss, ergibt sich eine erhöhte Produktivität, die sich bei vollautomatischen Maschinen (Mehrspindelschrauber) ganz besonders auswirkt.

Les parois en biais des douilles en 6-pans Pathfinder assurent l'engagement quasi immédiat de l'écrou. Le fait de ne pas devoir arrêter la machine après chaque serrage, engendre une productivité supérieure dans les chaînes de montage automatiques.

12425 (E)	D ₁ (mm)	D ₂ (mm)	H (mm)	L (mm)	(g)	(pcs.)	
E 4	6.6	13	4.6	23	14	10	*1
E 5	7.7	13	5.2	23	15	10	*1
E 6	8.7	13	5.4	23	15	10	*1
E 7	9.2	13	6.6	23	15	10	*1
E 8	9.7	13	7	23	15	10	*1
E10	12.2	13	8.2	23	15	10	*1

*1 Pin/O-Ring=A21/B21 → P269

12425 TORX® Sockets
TORX® Steckschlüssel
Douilles TORX®

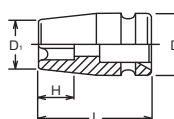

TORX® (E)

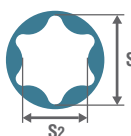

E	E4	E5	E6	E7	E8	E10	E11	E12	E14	E16	E18	E20	E22	E24	E26	E28	E30	E32
S ₁ (ref. mm)	3.7	4.6	5.6	6.1	7.4	9.3	9.9	11.0	12.8	14.6	16.5	18.3	20.1	22.0	23.7	25.5	27.3	29.0
S ₂ (ref. mm)	2.7	3.3	4.0	4.3	5.3	6.8	7.1	7.9	9.2	10.5	11.9	13.2	14.8	15.7	17.5	18.3	20.0	21.3

12460M (mm)	D ₁ (mm)	D ₂ (mm)	H (mm)	L (mm)	(g)	(pcs.)	
5.5	9.7	13	4	23	15	10	*1
6	10.3	13	5	23	15	10	*1
7	11.6	13	5	23	16	10	*1
8	12.8	13	6	23	16	10	*1
10	15.3	13	7	23	19	10	*1
13	19.1	13	8	23	23	10	*1

12460A (inch)	D ₁ (mm)	D ₂ (mm)	H (mm)	L (mm)	(g)	(pcs.)	
1/4	10.3	13	5	23	15	10	*1
5/16	12.8	13	6	23	16	10	*1
3/8	15.3	13	7	23	19	10	*1
1/2	19.1	13	8	23	23	10	*1

*1 Pin/O-Ring=A21/B21 → P269

12460M / 12460A For Self-Tapping Screws
Für selbstschneidende Schrauben
Pour vis auto-taraudeuses

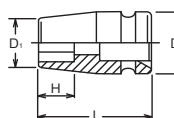

Socket for Self-Tapping Screws without infeed slope.

Steckschlüssel für selbstschneidende Schrauben 6-kant ohne Einlaufschräge.

Douille pour vis auto-taraudeuses hexagonales sans biseau d'entrée.

12460MG (mm)	D ₁ (mm)	D ₂ (mm)	H (mm)	L (mm)	(g)	(pcs.)	
5.5	9.7	13	2.1	23	16	10	*1
6	10.3	13	2.4	23	16	10	*1
7	11.6	13	2.8	23	16	10	*1
8	12.8	13	3.5	25	18	10	*1
10	15.3	13	4.2	28	20	10	*1
12	17.9	13	8	30	41	10	*1
13	19.1	13	6	30	23	10	*1
14	20	13	6.4	30	24	10	*1

12460AG (inch)	D ₁ (mm)	D ₂ (mm)	H (mm)	L (mm)	(g)	(pcs.)	
1/4	10.3	13	2.4	23	16	10	*1
5/16	12.8	13	3.5	25	18	10	*1
3/8	15.3	13	4.2	28	20	10	*1
7/16	16.6	13	4.9	29	27	10	*1
1/2	19.1	13	6	30	23	10	*1

*1 Pin/O-Ring=A21/B21 → P269

12460MG / 12460AG

(MG) With Magnet for Self-Tapping Screws
mit Magnet für selbstschneidende Schrauben
avec aimant pour vis auto-taraudeuses

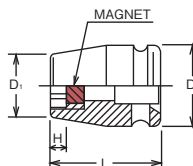

Socket with Magnet for Self-Tapping Screws without infeed slope.

Steckschlüssel mit Magnet für Selbstschneidende Schrauben 6-kant ohne Einlaufschräge.

Douille avec aimant pour vis auto-taraudeuses hexagonales sans biseau d'entrée.

TORX is a registered trademark of CAMCAR Innovations.
TORX ist ein registriertes Markenzeichen der Firma CAMCAR Innovations.
TORX est une marque déposée de CAMCAR Innovations.

Impact Sockets Impact Steckschlüssel Douilles Impact

1/4"

Z-SERIES
HAND
TITANIUM
SCREWDRIVERS ACCESSORIES
IMPACT
SLEEVE-DRIVE
PROTECTOR
INDUSTRIAL
AUTOMOTIVE
MOTORCYCLE
CONSTRUCTION
SPARE PART

12300M

6-point Sockets, deep
6-kant Steckschlüssel, lang
Douilles longues, 6-pans



12300M (mm)	D ₁ (mm)	D ₂ (mm)	H ₁ (mm)	H ₂ (mm)	L (mm)	(g)	(pcs.)	
6	10	13	6	38	48	26	10	*1
7	11.3	13	7	38	48	30	10	*1
8	12.5	13	8	38	48	32	10	*1
10	15	13	10	37	48	34	10	*1
11	16.3	13	11	37	48	46	10	*1
12	17.5	13	12	37	48	49	10	*1
13	18.8	13	13	37	48	52	10	*1
14	20	13	14	36	48	57	10	*1

*1 Pin/O-Ring=A21/B21 → P269

12365M

Pathfinder Sockets, deep
Pathfinder Steckschlüssel, lang
Douilles longues, Pathfinder



12365M (mm)	D ₁ (mm)	D ₂ (mm)	H ₁ (mm)	H ₂ (mm)	L (mm)	(g)	(pcs.)	
10	15	13	8	37	48	34	10	*1
11	16.3	13	8	37	48	46	10	*1
12	17.5	13	9	37	48	49	10	*1
13	18.8	13	9	37	48	52	10	*1

*1 Pin/O-Ring=A21/B21 → P269

12300G

Impact Socket with Sliding Magnet
Impact Steckschlüssel mit versenkbarem Magnet
Douilles Impact avec aimant, glissant pour écrous

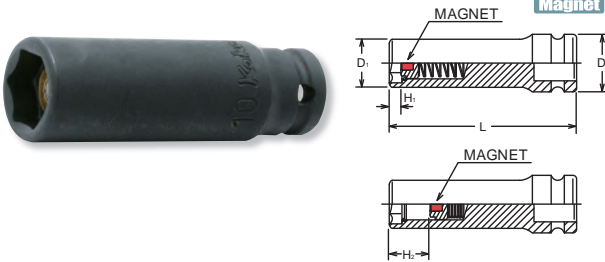

12300G (mm)	D ₁ (mm)	D ₂ (mm)	H ₁ (mm)	H ₂ (mm)	L (mm)	(g)	(pcs.)	
7	11.3	13	3.5	25	48	30	10	*1
8	12.5	13	4	22	48	32	10	*1
10	15	13	4.5	20.5	48	34	10	*1
12	17.5	13	6	24.5	48	49	10	*1
13	18.8	13	6.5	23	48	52	10	*1
14	20	13	7	21	48	57	10	*1

*1 Pin/O-Ring=A21/B21 → P269



12139

Impact Bit Holder
Impact Klingenthaler
Porte embouts Impact



	D ₁ (mm)	D ₂ (mm)	L (mm)	(g)	(pcs.)	
12139-1/4	11	13	25	15	10	*1

*1 Pin/O-Ring=A21/B21 → P269

For DIN3126 C6.3 Bits
Für DIN3126 C6.3 Bits
Pour DIN3126 C6.3 Embouts

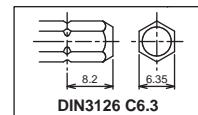

12140

Impact Bit Holder
Impact Klingenthaler
Porte embouts Impact



	D ₁ (mm)	D ₂ (mm)	L (mm)	(g)	(pcs.)	
12140-5/16	14	13	25	15	10	*1

*1 Pin/O-Ring=A21/B21 → P269

For DIN3126 C8 Bits
Für DIN3126 C8 Bits
Pour DIN3126 C8 Embouts

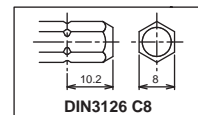

12142-F6.3

Impact Bit Holder
Impact Klingenthaler
Porte embouts Impact

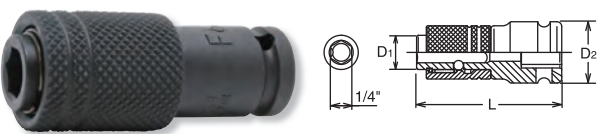

	D ₁ (mm)	D ₂ (mm)	L (mm)	(g)	(pcs.)	
12142-F6.3	16.5	13	40	22	10	*1

*1 Pin/O-Ring=A21/B21 → P269

For DIN3126 E6.3 Bits
Für DIN3126 E6.3 Bits
Pour DIN3126 E6.3 Embouts

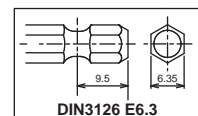

Lock & Quick Release

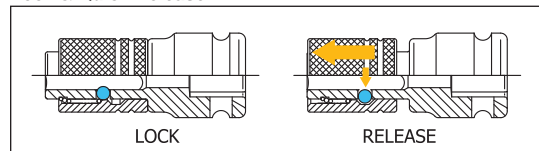

! You may not hold the sliding part while moving to avoid heating up by friction and reduction by wear.

	TYPE	D (mm)	L (mm)	(g)	(pcs.)	
12760-55P	Pin	13	55	26	10	*1
12760-75P	Pin	13	75	45	10	*1
12760-100P	Pin	13	100	50	10	*1
12760-150P	Pin	13	150	60	10	*1
12760-200P	Pin	13	200	80	10	*1

	TYPE	D (mm)	L (mm)	(g)	(pcs.)	
12760-55	Hole	13	55	26	10	*1
12760-75	Hole	13	75	45	10	*1
12760-100	Hole	13	100	50	10	*1
12760-150	Hole	13	150	60	10	*1
12760-200	Hole	13	200	80	10	*1

*1 Pin/O-Ring=A21/B21 → P269

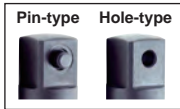

	L (mm)	(g)	(pcs.)	
12222AL	35	30	10	*1

*1 Pin/O-Ring=A21/B21 → P269

Lock & Quick Release

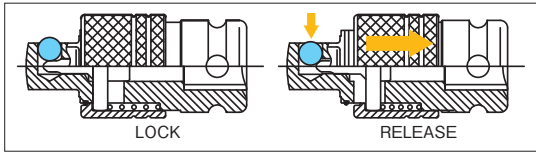

⚠ You may not hold the sliding part while moving to avoid heating up by friction and reduction by wear.

Bitte das gleitende Teil während der Bewegung nicht festhalten, um eine Erhitzung durch Reibung und durch Verschleiß zu vermeiden.

Vous ne devez pas tenir la partie coulissante pendant le déplacement afin d'éviter l'échauffement par frottement et la réduction par usure la réduction par l'usure.

	TYPE	L (mm)	(g)	(pcs.)	
12770-P	Pin	39	30	10	*1
12770	Hole	39	30	10	*1

*1 Pin/O-Ring=A21/B21 → P269

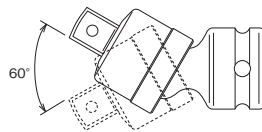

Our ball joints are spring-loaded and can therefore be adjusted to an angle of max. 30°.

Unsere Kugelgelenke sind federbelastet dadurch sind sie auf einen Winkel von max 30° einstellbar.

Nos joints à rotule sont à ressort et peuvent donc être réglés jusqu'à un angle de 30° maximum.

	TYPE	(sq.)	(sq.)	L (mm)	(g)	(pcs.)	
12233A-P	Pin	1/4"	3/8"	22	15	10	*1
12233A-B	Ball	1/4"	3/8"	22	15	10	*1
12233A	Hole	1/4"	3/8"	22	15	10	*1

*1 Pin/O-Ring=A21/B21 → P269

12760 Extension Bars Verlängerungen Rallonges

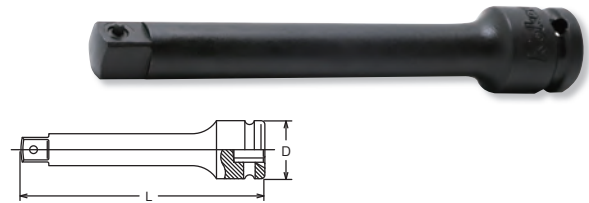

12222AL Adaptor (Quick Release) Schnellwechsel-Verbindungsstück Adaptateur autoserrant



12770 Universal Joint Gelenk-Einsatz Joint articulé



12233A Adaptor Verbindungsstück Augmentateur



Impact Sockets

Impact Steckschlüssel

Douilles Impact

3/8"

Z-SERIES
HAND
TITANIUM
SCREWDRIVERS ACCESSORIES
IMPACT
SLEEVE-DRIVE
PROTECTOR
INDUSTRIAL
AUTOMOTIVE
MOTORCYCLE
CONSTRUCTION
SPARE PART

13400M / 13400A

6-point Sockets
6-kant Steckschlüssel
Douilles 6-pans

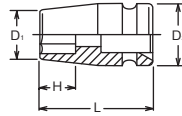

13400A (inch)	D ₁ (mm)	D ₂ (mm)	H (mm)	L (mm)	(g)	(pcs.)	
1/4	10.8	19	5	32	40	10	*1
5/16	13.3	19	6	32	40	10	*1
3/8	15.8	19	7	32	40	10	*1
7/16	17	19	8	32	41	10	*1
1/2	19.5	22	10	32	56	10	*2
9/16	20.8	22	10	32	56	10	*2
5/8	23.3	22	11	32	57	10	*2
11/16	24.5	22	12	32	60	10	*2
3/4	27	22	12	32	67	10	*2
13/16	29.5	22	12	32	71	10	*2
7/8	30.8	22	13	32	72	10	*2

*1 C-Ring=C31, Pin/O-Ring=A31/B31
*2 C-Ring=C32, Pin/O-Ring=A32/B32

13400M (mm)	D ₁ (mm)	D ₂ (mm)	H (mm)	L (mm)	(g)	(pcs.)	
6	10.8	19	5	32	40	10	*1
7	12	19	5	32	40	10	*1
8	13.3	19	6	32	40	10	*1
9	14.5	19	7	32	40	10	*1
10	15.8	19	7	32	40	10	*1
11	17	19	8	32	41	10	*1
12	18.3	19	9	32	43	10	*1
13	19.5	22	10	32	56	10	*2
14	20.8	22	10	32	56	10	*2
15	22	22	11	32	56	10	*2
16	23.3	22	11	32	57	10	*2
17	24.5	22	12	32	60	10	*2
18	25.8	22	12	32	62	10	*2
19	27	22	12	32	67	10	*2
20	28.3	22	12	32	70	10	*2
21	29.5	22	12	32	71	10	*2
22	30.8	22	13	32	72	10	*2
23	32	22	13	32	75	10	*2
24	33.3	22	13	32	78	10	*2

*1 C-Ring=C31, Pin/O-Ring=A31/B31
*2 C-Ring=C32, Pin/O-Ring=A32/B32

RS13400M/11

Socket Set on Rail
Steckschlüsselsatz auf Schiene
Jeu de douilles sur rail



RS13400M/11	11 Pieces Set/Rail 300mm	(g)
New	8, 10, 11, 12, 13, 14, 15, 16, 17, 18, 19	630

13405M / 13405A

12-point Sockets
12-kant Steckschlüssel
Douilles 12-pans

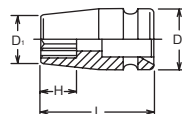

13405A (inch)	D ₁ (mm)	D ₂ (mm)	H (mm)	L (mm)	(g)	(pcs.)	
1/4	10.8	19	5	32	40	10	*1
5/16	13.3	19	6	32	40	10	*1
3/8	15.8	19	7	32	40	10	*1
7/16	17	19	8	32	41	10	*1
1/2	19.5	22	10	32	56	10	*2
9/16	20.8	22	10	32	56	10	*2
5/8	23.3	22	11	32	57	10	*2
11/16	24.5	22	12	32	60	10	*2
3/4	27	22	12	32	67	10	*2
13/16	29.5	22	12	32	71	10	*2
7/8	30.8	22	13	32	72	10	*2

*1 C-Ring=C31, Pin/O-Ring=A31/B31
*2 C-Ring=C32, Pin/O-Ring=A32/B32

13405M (mm)	D ₁ (mm)	D ₂ (mm)	H (mm)	L (mm)	(g)	(pcs.)	
8	13.3	19	6	32	40	10	*1
9	14.5	19	7	32	40	10	*1
10	15.8	19	7	32	40	10	*1
11	17	19	8	32	41	10	*1
12	18.3	19	9	32	43	10	*1
13	19.5	22	10	32	56	10	*2
14	20.8	22	10	32	56	10	*2
15	22	22	11	32	56	10	*2
16	23.3	22	11	32	57	10	*2
17	24.5	22	12	32	60	10	*2
18	25.8	22	12	32	62	10	*2
19	27	22	12	32	67	10	*2

*1 C-Ring=C31, Pin/O-Ring=A31/B31
*2 C-Ring=C32, Pin/O-Ring=A32/B32

3/8"

Impact Sockets
Impact Steckschlüssel
Douilles Impact

13401M / 13401A

6-point Socket, Thin Walled
6-kant Steckschlüssel, dünnwandig
Douilles à paroi mince, 6-pans



13401M (mm)	D ₁ (mm)	D ₂ (mm)	H (mm)	L (mm)	(g)	(pcs.)	
6	9.8	18.5	5	32	28	10	*1
7	11	18.5	5	32	30	10	*1
8	12.3	18.5	6	32	31	10	*1
9	13.5	18.5	7	32	32	10	*1
10	14.8	18.5	7	32	34	10	*1
11	16	18.5	8	32	35	10	*1
12	17.3	18.5	9	32	36	10	*1
13	18.5	21.5	10	32	43	10	*2
14	19.8	21.5	10	32	49	10	*2
15	21	21.5	11	32	49	10	*2
16	22.3	21.5	11	32	51	10	*2
17	23.5	21.5	12	32	54	10	*2
18	24.8	21.5	12	32	57	10	*2
19	26	21.5	12	32	60	10	*2
20	27.3	21.5	12	32	65	10	*2
21	28.5	21.5	12	32	70	10	*2
22	29.8	21.5	13	32	73	10	*2
23	31	21.5	13	32	73	10	*2
24	32.3	21.5	13	32	75	10	*2

*1 C-Ring=C31, Pin/O-Ring=A31/B31

*2 C-Ring=C32, Pin/O-Ring=A32/B32

→ P268-269

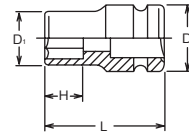

13401A (inch)	D ₁ (mm)	D ₂ (mm)	H (mm)	L (mm)	(g)	(pcs.)	
1/4	9.8	18.5	5	32	28	10	*1
5/16	12.3	18.5	6	32	31	10	*1
3/8	14.8	18.5	7	32	34	10	*1
7/16	16	18.5	8	32	35	10	*1
1/2	18.5	21.5	10	32	43	10	*2
9/16	19.8	21.5	10	32	49	10	*2
5/8	22.3	21.5	11	32	51	10	*2
11/16	23.5	21.5	12	32	54	10	*2
3/4	26	21.5	12	32	60	10	*2
13/16	28.5	21.5	12	32	70	10	*2
7/8	29.8	21.5	13	32	73	10	*2

*1 C-Ring=C31, Pin/O-Ring=A31/B31

*2 C-Ring=C32, Pin/O-Ring=A32/B32

→ P268-269

RS13401M/9	9 Pieces Set/Rail 250mm	(g)
8, 10, 12, 13, 14, 17, 19, 21, 22		505

RS13401M/9



Socket Set on Rail
Steckschlüsselsatz auf Schiene
Jeu de douilles sur rail



13406M (mm)	D ₁ (mm)	D ₂ (mm)	H (mm)	L (mm)	(g)	(pcs.)	
6	9.8	18.5	5	32	28	10	*1
7	11	18.5	5	32	30	10	*1
8	12.3	18.5	6	32	31	10	*1
9	13.5	18.5	7	32	32	10	*1
10	14.8	18.5	7	32	34	10	*1
11	16	18.5	8	32	35	10	*1
12	17.3	18.5	9	32	36	10	*1
13	18.5	21.5	10	32	43	10	*2
14	19.8	21.5	10	32	49	10	*2
15	21	21.5	11	32	49	10	*2
16	22.3	21.5	11	32	51	10	*2
17	23.5	21.5	12	32	54	10	*2
18	24.8	21.5	12	32	57	10	*2
19	26	21.5	12	32	60	10	*2
20	27.3	21.5	12	32	65	10	*2
21	28.5	21.5	12	32	70	10	*2
22	29.8	21.5	13	32	73	10	*2
23	31	21.5	13	32	73	10	*2
24	32.3	21.5	13	32	75	10	*2

*1 C-Ring=C31, Pin/O-Ring=A31/B31

*2 C-Ring=C32, Pin/O-Ring=A32/B32

→ P268-269

13406M / 13406A

12-point Socket, Thin Walled
12-kant Steckschlüssel, dünnwandig
Douilles à paroi mince, 12-pans

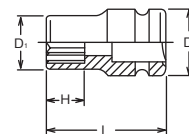

13406A (inch)	D ₁ (mm)	D ₂ (mm)	H (mm)	L (mm)	(g)	(pcs.)	
1/4	9.8	18.5	5	32	28	10	*1
5/16	12.3	18.5	6	32	31	10	*1
3/8	14.8	18.5	7	32	34	10	*1
7/16	16	18.5	8	32	35	10	*1
1/2	18.5	21.5	10	32	43	10	*2
9/16	19.8	21.5	10	32	49	10	*2
5/8	22.3	21.5	11	32	51	10	*2
11/16	23.5	21.5	12	32	54	10	*2
3/4	26	21.5	12	32	60	10	*2
13/16	28.5	21.5	12	32	70	10	*2
7/8	29.8	21.5	13	32	73	10	*2

*1 C-Ring=C31, Pin/O-Ring=A31/B31

*2 C-Ring=C32, Pin/O-Ring=A32/B32

→ P268-269

Z-SERIES
HAND
TITANIUM
ACCESSORIES
SCREWDRIVERS
IMPACT
SLEEVE-DRIVE
PROTECTOR
INDUSTRIAL
AUTOMOTIVE
MOTORCYCLE
CONSTRUCTION
SPARE PART

Impact Sockets

Impact Steckschlüssel

Douilles Impact

3/8"

Z-SERIES
HAND
TITANIUM
SCREWDRIVERS ACCESSORIES
IMPACT
SLEEVE-DRIVE
PROTECTOR
INDUSTRIAL
AUTOMOTIVE
CONSTRUCTION MOTORCYCLE
SPARE PART

13401MS

6-point short sockets, Thin Walled
6-kant Steckschlüssel kurz, dünnwandig
Douilles 6-pans courtes, a paroi mince

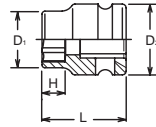

13401MS (mm)	D ₁ (mm)	D ₂ (mm)	H (mm)	L (mm)	(g)	(pcs.)	
8	12.3	18.5	6	22	25	10	*1
10	14.8	18.5	6	22	25	10	*1
11	16	18.5	10	22	24	10	*1
12	17.3	18.5	10	22	20	10	*1
13	18.5	21.5	10	22	30	10	*2
14	19.8	21.5	10	22	30	10	*2
15	20.9	21.5	10	25	38	10	*2
16	22.3	21.5	10	25	39	10	*2
17	23.5	21.5	10	25	41	10	*2
18	24.8	21.5	10	25	43	10	*2
19	26	21.5	10	25	44	10	*2

*1 C-Ring=C31, Pin/O-Ring=A31/B31
*2 C-Ring=C32, Pin/O-Ring=A32/B32

RS13401MS/11

Socket Set on Rail
Steckschlüsselsatz auf Schiene
Jeu de douilles sur rail



RS13401MS/11	11 Pieces Set/Rail 300mm	(g)
8, 10, 11, 12, 13, 14, 15, 16, 17, 18, 19		400

13400MG / 13400AG

6-point Sockets with Magnet
6-kant Steckschlüssel mit Magnet
Douilles 6-pans avec aimant

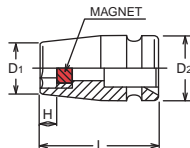

13400AG (inch)	D ₁ (mm)	D ₂ (mm)	H (mm)	L (mm)	(g)	(pcs.)	
1/4	10.8	19	2.4	32	46	10	*1
5/16	13.3	19	3.5	32	45	10	*1
11/32	14.5	19	3.8	32	44	10	*1
3/8	15.8	19	4.2	32	49	10	*1
7/16	17	19	4.9	32	50	10	*1
1/2	19.5	22	6	32	70	10	*2
9/16	20.8	22	6.4	32	76	10	*2
5/8	23.3	22	7	32	88	10	*2
11/16	24.5	22	7.5	32	95	10	*2
3/4	27	22	8	32	116	10	*2

*1 C-Ring=C31, Pin/O-Ring=A31/B31
*2 C-Ring=C32, Pin/O-Ring=A32/B32

13400MG (mm)	D ₁ (mm)	D ₂ (mm)	H (mm)	L (mm)	(g)	(pcs.)	
6	10.8	19	2.4	32	46	10	*1
7	12	19	2.8	32	45	10	*1
8	13.3	19	3.5	32	45	10	*1
9	14.5	19	3.8	32	44	10	*1
10	15.8	19	4.2	32	49	10	*1
11	17	19	4.9	32	50	10	*1
12	18.3	19	5.6	32	55	10	*1
13	19.5	22	6	32	70	10	*2
14	20.8	22	6.4	32	76	10	*2
15	22	22	6.8	32	76	10	*2
16	23.3	22	7	32	88	10	*2
17	24.5	22	7.5	32	95	10	*2
18	25.8	22	7.8	32	105	10	*2
19	27	22	8	32	116	10	*2
21	29.5	22	8	32	125	10	*2
22	30.8	22	9.5	32	135	10	*2

*1 C-Ring=C31, Pin/O-Ring=A31/B31
*2 C-Ring=C32, Pin/O-Ring=A32/B32

13410M

Surface Drive Sockets
Surface Drive Steckschlüssel
Douilles, Surface Drive

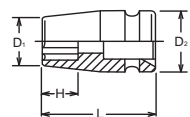

13410M (mm)	D ₁ (mm)	D ₂ (mm)	H (mm)	L (mm)	(g)	(pcs.)	
6	10.8	19	5	32	40	10	*1
7	12	19	5	32	40	10	*1
8	13.3	19	6	32	40	10	*1
9	14.5	19	7	32	40	10	*1
10	15.8	19	7	32	40	10	*1
11	17	19	8	32	42	10	*1
12	18.3	19	9	32	50	10	*1
13	19.5	22	10	32	56	10	*2
14	20.8	22	10	32	56	10	*2
15	22	22	11	32	56	10	*2
16	23.3	22	11	32	57	10	*2
17	24.5	22	12	32	60	10	*2
18	25.8	22	12	32	62	10	*2
19	27	22	12	32	67	10	*2
22	30.8	22	13	32	72	10	*2

*1 C-Ring=C31, Pin/O-Ring=A31/B31
*2 C-Ring=C32, Pin/O-Ring=A32/B32

13465M (mm)	D ₁ (mm)	D ₂ (mm)	H (mm)	L (mm)	(g)	(pcs.)	
8	13.3	19	8	32	40	10	*1
10	15.8	19	8	32	43	10	*1
11	17	19	8	32	44	10	*1
12	18.3	19	9	32	47	10	*1
13	19.5	22	9	32	55	10	*2
14	20.8	22	11	32	56	10	*2
15	22	22	11	32	56	10	*2
16	23.3	22	11	32	57	10	*2
17	24.5	22	12	32	60	10	*2
18	25.8	22	13	32	63	10	*2
19	27	22	13	32	66	10	*2

*1 C-Ring=C31, Pin/O-Ring=A31/B31 → P268-269
*2 C-Ring=C32, Pin/O-Ring=A32/B32



13465M Pathfinder Sockets Pathfinder Steckschlüssel Douilles Pathfinder

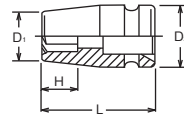

13460M (mm)	D ₁ (mm)	D ₂ (mm)	H (mm)	L (mm)	(g)	(pcs.)	
6	11.4	19	5	32	43	10	*1
7	12.8	19	5	32	44	10	*1
8	14.1	19	6	32	44	10	*1
10	16.6	19	7	32	45	10	*1
12	19	19.2	9	32	48	10	*2
13	20.3	22	10	32	60	10	*2

13460A (inch)	D ₁ (mm)	D ₂ (mm)	H (mm)	L (mm)	(g)	(pcs.)	
1/4	11.4	19	5	32	43	10	*1
3/8	16.6	19	7	32	45	10	*1
1/2	20.3	22	10	32	60	10	*2

*1 C-Ring=C31, Pin/O-Ring=A31/B31 → P268-269
*2 C-Ring=C32, Pin/O-Ring=A32/B32

13460M / 13460A For Self-Tapping Screws Für selbstschneidende Schrauben Pour vis auto-taraudeuses

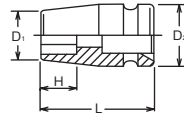

Socket for Self-Tapping Screws without infeed slope.
Steckschlüssel für selbstschneidende Schrauben 6-kant ohne Einlaufschräge.
Douille pour vis auto-taraudeuses hexagonales sans biseau d'entrée.

13460MG (mm)	D ₁ (mm)	D ₂ (mm)	H (mm)	L (mm)	(g)	(pcs.)	
6	11.4	19	2.4	32	44	10	*1
7	12.8	19	2.8	32	46	10	*1
8	14.1	19	3.5	32	48	10	*1
10	16.6	19	4.2	33	54	10	*1
13	20.3	22	6	34	81	10	*2

13460AG (inch)	D ₁ (mm)	D ₂ (mm)	H (mm)	L (mm)	(g)	(pcs.)	
1/4	11.4	19	2.4	32	44	10	*1
5/16	14.1	19	3.5	32	48	10	*1
3/8	16.6	19	4.2	33	54	10	*1
1/2	20.3	22	6	34	81	10	*2

*1 C-Ring=C31, Pin/O-Ring=A31/B31 → P268-269
*2 C-Ring=C32, Pin/O-Ring=A32/B32

13460MG / 13460AG Sockets with magnets for Self-Tapping Screws Steckschlüssel mit Magnet für selbstschneidende Schrauben Douilles avec aimant pour vis auto-taraudeuses

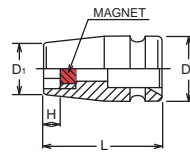

Socket with Magnet for Self-Tapping Screws without infeed slope.
Steckschlüssel mit Magnet für Selbstschneidende Schrauben 6-kant ohne Einlaufschräge.
Douille avec aimant pour vis auto-taraudeuses hexagonales sans biseau d'entrée.

Impact Sockets Impact Steckschlüssel Douilles Impact

3/8"

Z-SERIES
HAND
TITANIUM
SCREWDRIVERS
ACCESSORIES
IMPACT
SLEEVE-DRIVE
PROTECTOR
INDUSTRIAL
AUTOMOTIVE
MOTORCYCLE
CONSTRUCTION
SPARE PART

13425

TORX® Sockets
TORX® Steckschlüssel
Douilles TORX®

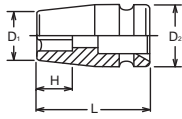

13425 (E)	D ₁ (mm)	D ₂ (mm)	H (mm)	L (mm)	(g)	(pcs.)	
E 4	9.7	19	4.6	32	44	10	*1
E 5	10.2	19	5.2	32	43	10	*1
E 6	10.7	19	5.4	32	44	10	*1
E 7	11.2	19	6.6	32	44	10	*1
E 8	11.7	19	7	32	44	10	*1
E10	12.2	19	8.2	32	42	10	*1
E11	13.2	19	8.7	32	43	10	*1
E12	14.2	19	9.3	32	43	10	*1
E14	17.2	19	10.6	32	44	10	*1
E16	18.2	19	11.8	32	42	10	*1

*1 C-Ring=C31, Pin/O-Ring=A31/B31 → P268-269

TORX® (E)

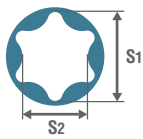

E	E4	E5	E6	E7	E8	E10	E11	E12	E14	E16	E18	E20	E22	E24	E26	E28	E30	E32
S ₁ (ref. mm)	3.7	4.6	5.6	6.1	7.4	9.3	9.9	11.0	12.8	14.6	16.5	18.3	20.1	22.0	23.7	25.5	27.3	29.0
S ₂ (ref. mm)	2.7	3.3	4.0	4.3	5.3	6.8	7.1	7.9	9.2	10.5	11.9	13.2	14.8	15.7	17.5	18.3	20.0	21.3

13425EG

TORX® Sockets with Magnet
TORX® Steckschlüssel mit Magnet
Douilles TORX® avec aimant

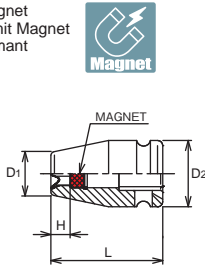

13425EG (E)	D ₁ (mm)	D ₂ (mm)	H (mm)	L (mm)	(g)	(pcs.)	
E 8	11.7	19	5	32	54	10	*1
E10	12.2	19	5.5	32	52	10	*1
E12	14.2	19	6.5	32	53	10	*1
E14	17.2	19	7	32	54	10	*1

*1 C-Ring=C31, Pin/O-Ring=A31/B31 → P268-269

13425 (EPL)

TORXPLUS® Sockets
TORXPLUS® Steckschlüssel
Douilles TORXPLUS®

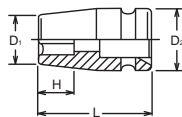

13425 (EPL)	D ₁ (mm)	D ₂ (mm)	H (mm)	L (mm)	(g)	(pcs.)	
8EPL	11.7	19	5.2	32	44	10	*1
10EPL	12.2	19	6.2	32	44	10	*1
12EPL	14.2	19	7.2	32	44	10	*1
14EPL	17.2	19	8.1	32	46	10	*1
16EPL	18.2	19	9.2	32	41	10	*1

*1 C-Ring=C31, Pin/O-Ring=A31/B31 → P268-269

TORXplus® (EP/EPL)

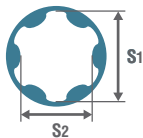

EP/EPL	8EP	10EP	12EP	14EP	16EP	18EP	20EP	22EP	24EP	26EP	28EP	30EP	32EP
S ₁ (ref. mm)	7.4	9.3	11.0	12.8	14.6	16.5	18.3	20.1	22.0	23.7	25.5	27.3	29.0
S ₂ (ref. mm)	5.7	7.1	8.5	9.8	11.2	12.7	14.0	15.4	16.8	18.2	19.6	20.9	22.3

13425 (EPRL)

Tamper-Resistant TORXPLUS® Sockets
Tamper-Resistant TORXPLUS® Steckschlüssel
Douilles Tamper-Resistant TORXPLUS®

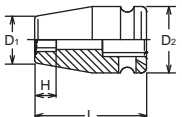

13425 (EPRL)	D ₁ (mm)	D ₂ (mm)	H (mm)	L (mm)	(g)	(pcs.)	
New 10EPRL	12.2	19	6.2	32	44	10	*1
New 12EPRL	14.2	19	7.2	32	44	10	*1
New 14EPRL	17.2	19	8.1	32	46	10	*1

*1 C-Ring=C31, Pin/O-Ring=A31/B31 → P268-269

13401LH (LH-S)	D ₁ (mm)	D ₂ (mm)	H (mm)	L (mm)	(g)	(pcs.)	
5S	11	19	5	32	32	10	*1
6S	12.3	19	5.6	32	34	10	*1
8S	16	19	6.8	32	36	10	*1
10S	18.5	22	8	32	50	10	*2
12S	22.3	22	9.2	32	58	10	*2
14S	24.8	22	10.4	32	63	10	*2
16S	28.5	22	11.6	32	77	10	*2

*1 C-Ring=C31, Pin/O-Ring=A31/B31
*2 C-Ring=C32, Pin/O-Ring=A32/B32 → P268-269

13401LH



LHS Sockets
Steckschlüssel mit LHS Profil
Douilles au profil LHS

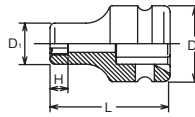

LHSTIX®

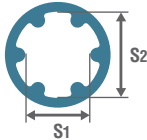

LH-S		LH-5S	LH-6S	LH-8S	LH-10S	LH-12S	LH-14S	LH-16S
S ₁	(ref. mm)	5.6	6.8	9.0	11.3	13.6	15.8	18.1
S ₂	(ref. mm)	7.5	9.0	12.0	15.0	18.0	21.0	24.0

13400-WN	D ₁ (mm)	D ₂ (mm)	H (mm)	L (mm)	(g)	(pcs.)	
6WN	15.8	19	6	32	48	10	*1
8WN	18.3	19	8	32	48	10	*1
9WN	19.5	22	9	32	47	10	*2
10WN	20.8	22	10	32	65	10	*2
12WN	24.5	22	12	32	73	10	*2
14WN	27	22	14	32	79	10	*2
17WN	32	22	17	35	110	10	*2

*1 C-Ring=C31, Pin/O-Ring=A31/B31
*2 C-Ring=C32, Pin/O-Ring=A32/B32 → P268-269

13400-WN



Weld Nut Sockets
Steckschlüssel für Schweissmuttern
Douilles pour écrou à souder

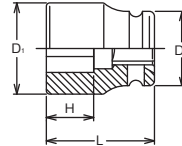

WN

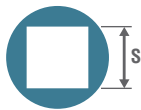

WN		6WN	8WN	9WN	10WN	12WN	14WN	17WN
S	(ref. mm)	6	8	9	10	12	14	17

13301X (mm)	D ₁ (mm)	D ₂ (mm)	H ₁ (mm)	H ₂ (mm)	L (mm)	(g)	(pcs.)	
6	9.8	18.5	6	36.5	50	35	10	*1
7	11	18.5	7	36.5	50	40	10	*1
8	12.3	18.5	8	36.5	50	40	10	*1
10	14.8	18.5	10	36.5	50	46	10	*1
11	16	18.5	11	36.5	50	49	10	*1
12	17.3	18.5	12	36.5	50	53	10	*1
13	18.5	21.5	13	36.5	50	67	10	*2
14	19.8	21.5	14	36.5	50	70	10	*2
15	21	21.5	15	35.5	50	75	10	*2
16	22.3	21.5	16	35.5	50	78	10	*2
17	23.5	21.5	17	35.5	50	82	10	*2
18	24.8	21.5	18	34.5	50	86	10	*2
19	26	21.5	19	34.5	50	93	10	*2
21	28.5	21.5	21	34.5	50	104	10	*2
22	29.8	21.5	22	33.5	50	110	10	*2
23	31	21.5	23	33.5	50	115	10	*2
24	32.3	21.5	24	32.5	50	120	10	*2

*1 C-Ring=C31, Pin/O-Ring=A31/B31
*2 C-Ring=C32, Pin/O-Ring=A32/B32 → P268-269



13301X



6-point Semi-Deep Socket, Thin Walled
6-kant Steckschlüssel mittel lang, dünnwandig
Douilles à paroi mince semi-longues, 6-pans

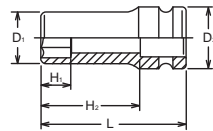

RS13301X/9	9 Pieces Set/Rail 250mm	(g)
8, 10, 12, 13, 14, 17, 19, 21, 22		710

RS13301X/9



Socket Set on Rail
Steckschlüsselsatz auf Schiene
Jeu de douilles sur rail



Impact Sockets

Impact Steckschlüssel

Douilles Impact

3/8"

Z-SERIES
HAND
TITANIUM
SCREWDRIVERS ACCESSORIES
IMPACT
SLEEVE-DRIVE
PROTECTOR
INDUSTRIAL
AUTOMOTIVE
CONSTRUCTION MOTORCYCLE
SPARE PART

13300XG

MG Impact semi-deep socket with Sliding Magnet
Impact Steckschlüssel mittel lang mit versenkbarem Magnet
Douilles semi-longues avec aimant, glissant pour écrous

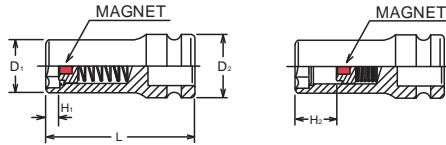

13300XG (mm)	D ₁ (mm)	D ₂ (mm)	H ₁ (mm)	H ₂ (mm)	L (mm)	(g)	(pcs.)	
7	12	19	3.5	19	50	52	10	*1
8	13.3	19	4	20.5	50	40	10	*1
10	15.8	19	4.5	20	50	46	10	*1
11	17	19	5	20	50	50	10	*1
12	18.3	19	6	20	50	55	10	*1
13	19.5	22	6.5	19	50	70	10	*2
14	20.8	22	7	18	50	75	10	*2
15	21.9	22	7	18	50	85	10	*2
16	23.2	22	7.5	20	50	114	10	*2
17	24.4	22	8	20	50	126	10	*2

*1 C-Ring=C31, Pin/O-Ring=A31/B31
*2 C-Ring=C32, Pin/O-Ring=A32/B32 → P268-269

13300M / 13300A

6-point Sockets, deep
6-kant Steckschlüssel, lang
Douilles longues, 6-pans

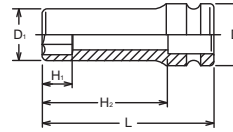

13300A (inch)	D ₁ (mm)	D ₂ (mm)	H ₁ (mm)	H ₂ (mm)	L (mm)	(g)	(pcs.)	
1/4	10.8	19	6	66.5	80	77	10	*1
5/16	13.3	19	8	66.5	80	82	10	*1
3/8	15.8	19	10	66.5	80	94	10	*1
7/16	17	19	11	66.5	80	110	10	*1
1/2	19.5	22	13	66.5	80	138	10	*2
9/16	20.8	22	14	66.5	80	148	10	*2
5/8	23.3	22	16	65.5	80	156	10	*2
11/16	24.5	22	17	65.5	80	168	10	*2
3/4	27	22	19	64.5	80	192	10	*2
13/16	29.5	22	21	64.5	80	226	10	*2
7/8	30.8	22	22	63.5	80	231	10	*2

*1 C-Ring=C31, Pin/O-Ring=A31/B31
*2 C-Ring=C32, Pin/O-Ring=A32/B32 → P268-269

13300M (mm)	D ₁ (mm)	D ₂ (mm)	H ₁ (mm)	H ₂ (mm)	L (mm)	(g)	(pcs.)	
6	10.8	19	6	66.5	80	77	10	*1
7	12	19	7	66.5	80	82	10	*1
8	13.3	19	8	66.5	80	82	10	*1
9	14.5	19	9	66.5	80	88	10	*1
10	15.8	19	10	66.5	80	94	10	*1
11	17	19	11	66.5	80	110	10	*1
12	18.3	19	12	66.5	80	111	10	*1
13	19.5	22	13	66.5	80	138	10	*2
14	20.8	22	14	66.5	80	148	10	*2
15	22	22	15	65.5	80	157	10	*2
16	23.3	22	16	65.5	80	156	10	*2
17	24.5	22	17	65.5	80	168	10	*2
18	25.8	22	18	64.5	80	190	10	*2
19	27	22	19	64.5	80	192	10	*2
20	28.3	22	20	64.5	80	224	10	*2
21	29.5	22	21	64.5	80	226	10	*2
22	30.8	22	22	63.5	80	231	10	*2
23	31.9	22	23	63.5	80	238	10	*2
24	33.2	22	24	63.5	80	242	10	*2

13301M / 13301A

6-point Deep Socket, Thin Walled
6-kant Steckschlüssel, dünnwandig
Douilles à paroi mince longues, 6-pans

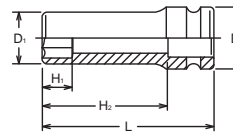

13301A (inch)	D ₁ (mm)	D ₂ (mm)	H ₁ (mm)	H ₂ (mm)	L (mm)	(g)	(pcs.)	
1/4	10	18.5	6	66.5	80	65	10	*1
5/16	12.3	18.5	8	66.5	80	68	10	*1
3/8	14.8	18.5	10	66.5	80	72	10	*1
7/16	16	18.5	11	66.5	80	80	10	*1
1/2	18.5	21.5	13	66.5	80	100	10	*2
9/16	19.8	21.5	14	66.5	80	110	10	*2
5/8	22.3	21.5	16	65.5	80	130	10	*2
11/16	23.5	21.5	17	65.5	80	136	10	*2
3/4	26	21.5	19	64.5	80	155	10	*2
13/16	28.5	21.5	21	64.5	80	181	10	*2
7/8	29.8	21.5	22	63.5	80	190	10	*2

*1 C-Ring=C31, Pin/O-Ring=A31/B31
*2 C-Ring=C32, Pin/O-Ring=A32/B32 → P268-269

13301M (mm)	D ₁ (mm)	D ₂ (mm)	H ₁ (mm)	H ₂ (mm)	L (mm)	(g)	(pcs.)	
6	10	18.5	6	66.5	80	65	10	*1
7	11	18.5	7	66.5	80	66	10	*1
8	12.3	18.5	8	66.5	80	68	10	*1
9	13.5	18.5	9	66.5	80	70	10	*1
10	14.8	18.5	10	66.5	80	72	10	*1
11	16	18.5	11	66.5	80	80	10	*1
12	17.3	18.5	12	66.5	80	85	10	*1
13	18.5	21.5	13	66.5	80	100	10	*2
14	19.8	21.5	14	66.5	80	110	10	*2
15	21	21.5	15	65.5	80	120	10	*2
16	22.3	21.5	16	65.5	80	130	10	*2
17	23.5	21.5	17	65.5	80	136	10	*2
18	24.8	21.5	18	64.5	80	145	10	*2
19	26	21.5	19	64.5	80	155	10	*2
20	27.3	21.5	20	64.5	80	170	10	*2
21	28.5	21.5	21	64.5	80	181	10	*2
22	29.8	21.5	22	63.5	80	190	10	*2
24	32.3	21.5	24	63.5	80	216	10	*2

13305M (mm)	D ₁ (mm)	D ₂ (mm)	H ₁ (mm)	H ₂ (mm)	L (mm)	(g)	(pcs.)	
8	13.3	19	8	66.5	80	82	10	*1
10	15.8	19	10	66.5	80	94	10	*1
11	17	19	11	66.5	80	110	10	*1
12	18.3	19	12	66.5	80	111	10	*1
13	19.5	22	13	66.5	80	138	10	*2
14	20.8	22	14	66.5	80	148	10	*2
17	24.5	22	17	65.5	80	168	10	*2

*1 C-Ring=C31, Pin/O-Ring=A31/B31 → P268-269
*2 C-Ring=C32, Pin/O-Ring=A32/B32

13305M 12-point Sockets, deep
12-kant Steckschlüssel, lang
Douilles longues, 12-pans

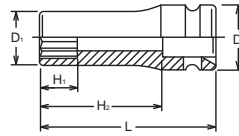

13306M (mm)	D ₁ (mm)	D ₂ (mm)	H ₁ (mm)	H ₂ (mm)	L (mm)	(g)	(pcs.)	
8	12.3	18.5	8	66.5	80	68	10	*1
10	14.8	18.5	10	66.5	80	72	10	*1
11	16	18.5	11	66.5	80	80	10	*1
12	17.3	18.5	12	66.5	80	85	10	*1
13	18.5	21.5	13	66.5	80	100	10	*2
14	19.8	21.5	14	66.5	80	110	10	*2
17	23.5	21.5	17	66.5	80	136	10	*2

*1 C-Ring=C31, Pin/O-Ring=A31/B31 → P268-269
*2 C-Ring=C32, Pin/O-Ring=A32/B32

13306M 12-point Deep Sockets, Thin Walled
12-kant Steckschlüssel, dünnwandig
Douilles à paroi mince longues, 12-pans

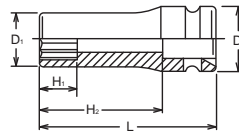

13310M (mm)	D ₁ (mm)	D ₂ (mm)	H ₁ (mm)	H ₂ (mm)	L (mm)	(g)	(pcs.)	
7	12	19	7	66.5	80	77	10	*1
8	13.3	19	8	66.5	80	90	10	*1
9	14.5	19	9	66.5	80	90	10	*1
10	15.8	19	10	66.5	80	97	10	*1
11	17	19	11	66.5	80	110	10	*1
12	18.3	19	12	66.5	80	105	10	*1
13	19.5	22	13	66.5	80	135	10	*2
14	20.8	22	14	66.5	80	145	10	*2
15	22	22	15	65.5	80	160	10	*2
16	23.3	22	16	65.5	80	156	10	*2
17	24.5	22	17	65.5	80	168	10	*2
18	25.8	22	18	64.5	80	190	10	*2
19	27	22	19	64.5	80	190	10	*2

*1 C-Ring=C31, Pin/O-Ring=A31/B31 → P268-269
*2 C-Ring=C32, Pin/O-Ring=A32/B32



SURFACE DRIVE

13310M Surface Drive Sockets, deep
Surface Drive Steckschlüssel, lang
Douilles longues, Surface Drive

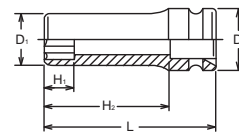

13300G (mm)	D ₁ (mm)	D ₂ (mm)	H ₁ (mm)	H ₂ (mm)	L (mm)	(g)	(pcs.)	
8	13.3	19	4	26.5	80	82	10	*1
10	15.8	19	4.5	26	80	105	10	*1
12	18.3	19	6	26	80	136	10	*1
13	19.5	22	6.5	25	80	165	10	*2
14	20.8	22	7	24	80	186	10	*2
15	22	22	7	24	80	195	10	*2
16	23.3	22	8	27	80	210	10	*2
17	24.5	22	8	27	80	220	10	*2
19	27	22	9	28	80	230	10	*2

*1 C-Ring=C31, Pin/O-Ring=A31/B31 → P268-269
*2 C-Ring=C32, Pin/O-Ring=A32/B32



SLIDE MAGNET

13300G Impact Socket with Sliding Magnet
Impact Steckschlüssel mit versenkbarem Magnet
Douilles Impact avec aimant, glissant pour écrous

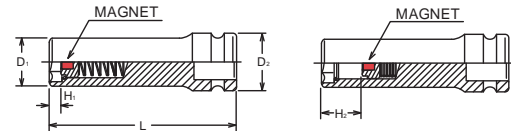

13365M (mm)	D ₁ (mm)	D ₂ (mm)	H ₁ (mm)	H ₂ (mm)	L (mm)	(g)	(pcs.)	
8	13.3	19	7	66.5	80	90	10	*1
10	15.8	19	8	66.5	80	99	10	*1
11	17	19	8	66.5	80	108	10	*1
12	18.3	19	9	66.5	80	110	10	*1
13	19.5	22	9	66.5	80	142	10	*2
14	20.8	22	11	66.5	80	144	10	*2
15	22	22	11	65.5	80	150	10	*2
16	23.3	22	11	65.5	80	159	10	*2
17	24.5	22	12	65.5	80	170	10	*2
18	25.8	22	13	64.5	80	201	10	*2
19	27	22	13	64.5	80	203	10	*2

*1 C-Ring=C31, Pin/O-Ring=A31/B31 → P268-269
*2 C-Ring=C32, Pin/O-Ring=A32/B32



PATHFINDER®

13365M Pathfinder Sockets, deep
Pathfinder Steckschlüssel, lang
Douilles longues, Pathfinder

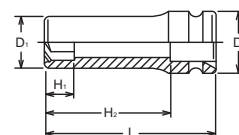

Impact Sockets Impact Steckschlüssel Douilles Impact

3/8"

Z-SERIES
HAND
TITANIUM
ACCESSORIES
SCREWDRIVERS
IMPACT
SLEEVE-DRIVE
PROTECTOR
INDUSTRIAL
AUTOMOTIVE
MOTORCYCLE
CONSTRUCTION
SPARE PART

13325

TORX® Deep Sockets
TORX® Steckschlüssel, lang
Douilles longues TORX®

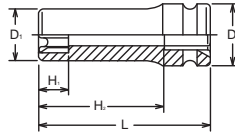

13325 (E)	D ₁ (mm)	D ₂ (mm)	H ₁ (mm)	H ₂ (mm)	L (mm)	(g)	(pcs.)	
E 7	11.2	19	6.6	66.5	80	75	10	*1
E 8	11.7	19	7	66.5	80	80	10	*1
E10	12.2	19	8.2	66.5	80	85	10	*1
E12	14.2	19	9.3	66.5	80	90	10	*1
E14	17.2	19	10.6	66.5	80	110	10	*1
E16	18.2	19	11.8	66.5	80	110	10	*1

*1 C-Ring=C31, Pin/O-Ring=A31/B31 → P268-269

TORX® (E)

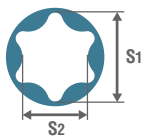

E	E4	E5	E6	E7	E8	E10	E11	E12	E14	E16	E18	E20	E22	E24	E26	E28	E30	E32
S ₁ (ref. mm)	3.7	4.6	5.6	6.1	7.4	9.3	9.9	11.0	12.8	14.6	16.5	18.3	20.1	22.0	23.7	25.5	27.3	29.0
S ₂ (ref. mm)	2.7	3.3	4.0	4.3	5.3	6.8	7.1	7.9	9.2	10.5	11.9	13.2	14.8	15.7	17.5	18.3	20.0	21.3

13440M / 13440A

Universal Sockets
Gelenk-Einsätze
Douilles universelles

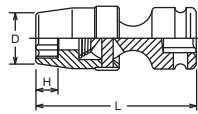

13440M (mm)	D (mm)	H (mm)	L (mm)	(g)	(pcs.)	
10	15.8	5	57	135	10	*2
11	17	6	57	135	10	*2
12	18.3	6	57	135	10	*2
13	19.5	6	57	135	10	*2
14	20.8	7	59	140	10	*2
15	22	7	59	140	10	*2
16	23.3	8	59	140	10	*2
17	24.5	8	59	140	10	*2
18	25.8	9	61	148	10	*2
19	27	10	61	152	10	*2
20	29.5	10	61	157	10	*2
21	30.7	14	66	205	10	*2
22	32	13	66	210	10	*2
24	34.5	13	68	215	10	*2

13440A (inch)	D (mm)	H (mm)	L (mm)	(g)	(pcs.)	
3/8	15.8	5	57	135	10	*2
7/16	17	6	57	135	10	*2
1/2	19.5	6	57	135	10	*2
9/16	20.8	7	59	140	10	*2
5/8	23.3	8	59	140	10	*2
11/16	24.5	8	59	140	10	*2
3/4	27	10	61	152	10	*2

*2 C-Ring=C32, Pin/O-Ring=A32/B32 → P268-269

13440T

TORX® Universal Sockets
TORX® Gelenk-Einsätze
Douilles universelles TORX®

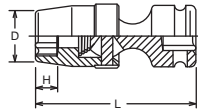

13440T (E)	D (mm)	H (mm)	L (mm)	(g)	(pcs.)	
E10	13.3	8.2	58	135	10	*2
E12	15.8	9.3	58	135	10	*2
E14	17	10.6	58	135	10	*2

*2 C-Ring=C32, Pin/O-Ring=A32/B32 → P268-269

13430M

Universal Inhex Sockets
Gelenk-Einsätze für Schrauben mit Innensechskant
Douilles universelles 6-pans mâles

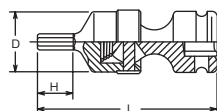

13430M (mm)	D (mm)	H (mm)	L (mm)	(g)	(pcs.)	
5	24	15	74	120	10	*2
6	24	15	74	131	10	*2
8	24	20	74	136	10	*2
10	24	20	74	141	10	*2
17	24	7	53	150	10	*2

*2 C-Ring=C32, Pin/O-Ring=A32/B32 → P268-269

13103M (mm)	D ₁ (mm)	D ₂ (mm)	H (mm)	L (mm)	(g)	(pcs.)	
5(0.8)	9.5	19	8	32	39	10	*1
6(1.0)	10.8	19	9	32	41	10	*1
7(1.0)	12.5	19	10	32	44	10	*1
8(1.25)	13.5	19	10.5	35	49	10	*1
10(1.25)	15.8	19	13	35	49	10	*1
10(1.5)	15.8	19	13	35	49	10	*1



13103M

Impact Stud Bolt Setters
Impact Stehbolzensetzer
Monte-goujons Impact

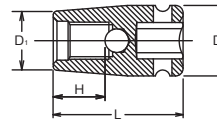

*1 C-Ring=C31, Pin/O-Ring=A31/B31 → P268-269

⚠ Depend on the stud bolt and using torque, 4103M/13103M/14103M may cause a scratch against the stud bolts or got stuck itself during a work.

A special socket for installing a stud bolt.
Inside steel ball prevent the stud bolt stuck onto the socket. After installing a stud bolt, turn to anti-clockwise to removing the socket.

Spezialwerkzeug zum Setzen von Stehbolzen. Der Bolzen trifft im Werkzeug nur auf den Stahlbolzen, was die Kontaktfläche verringert. Nach dem Setzen des Stehbolzens kann das Werkzeug im Linkslauf vom Stehbolzen abgezogen werden.

Douilles spéciales pour monter les goujons.
Le goujon est en contact avec une bille d'acier pour l'empêcher d'adhérer à la douille. Après avoir posé le goujon, tourner dans le sens antihorlogique pour le retirer

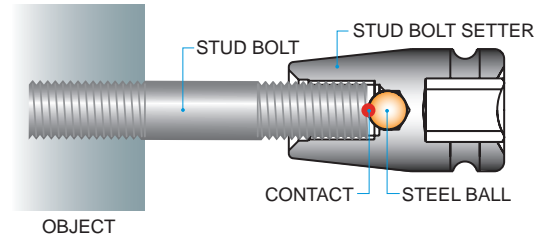

13145M-150 (mm)	D ₁ (mm)	D ₂ (mm)	H (mm)	L (mm)	(g)	(pcs.)	
6	10.8	19	6	150	105	5	*1
8	13.3	19	8	150	110	5	*1
10	15.8	19	10	150	120	5	*1
12	18.3	19	12	150	128	5	*1
13	19.5	19	13	150	137	5	*1
14	20.8	19	14	150	146	5	*1
15	22	19	15	150	155	5	*1
17	24.5	19	17	150	163	5	*1

13145M-200 (mm)	D ₁ (mm)	D ₂ (mm)	H (mm)	L (mm)	(g)	(pcs.)	
6	10.8	19	6	200	136	5	*1
8	13.3	19	8	200	141	5	*1
10	15.8	19	10	200	151	5	*1
12	18.3	19	12	200	159	5	*1
13	19.5	19	13	200	168	5	*1
14	20.8	19	14	200	177	5	*1
15	22	19	15	200	186	5	*1
17	24.5	19	17	200	194	5	*1

13145M-250 (mm)	D ₁ (mm)	D ₂ (mm)	H (mm)	L (mm)	(g)	(pcs.)	
6	10.8	19	6	250	167	5	*1
8	13.3	19	8	250	172	5	*1
10	15.8	19	10	250	182	5	*1
12	18.3	19	12	250	190	5	*1
13	19.5	19	13	250	199	5	*1
14	20.8	19	14	250	208	5	*1
15	22	19	15	250	217	5	*1
17	24.5	19	17	250	225	5	*1

*1 C-Ring=C31, Pin/O-Ring=A31/B31 → P268-269

13145MG-100 (mm)	D ₁ (mm)	D ₂ (mm)	H (mm)	L (mm)	(g)	(pcs.)	
8	13.3	19	3.5	100	90	5	*1
10	15.8	19	4.2	100	93	5	*1
12	18.3	19	5.6	100	105	5	*1
13	19.5	19	6	100	115	5	*1
14	20.8	19	6.4	100	120	5	*1

13145MG-150 (mm)	D ₁ (mm)	D ₂ (mm)	H (mm)	L (mm)	(g)	(pcs.)	
8	13.3	19	3.5	150	121	5	*1
10	15.8	19	4.2	150	125	5	*1
12	18.3	19	5.6	150	136	5	*1
13	19.5	19	6	150	145	5	*1
14	20.8	19	6.4	150	150	5	*1

13145MG-200 (mm)	D ₁ (mm)	D ₂ (mm)	H (mm)	L (mm)	(g)	(pcs.)	
10	15.8	19	4.2	200	182	5	*1
12	18.3	19	5.6	200	190	5	*1
13	19.5	19	6	200	208	5	*1
14	20.8	19	6.4	200	225	5	*1

*1 C-Ring=C31, Pin/O-Ring=A31/B31 → P268-269

13145M-100 / -150 / -200 / -250

Extra Long Sockets
Schaftsteckschlüssel
Douilles, série allongée

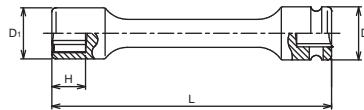

13145M-100 (mm)	D ₁ (mm)	D ₂ (mm)	H (mm)	L (mm)	(g)	(pcs.)	
8	13.3	19	8	100	90	5	*1
10	15.8	19	10	100	92	5	*1
12	18.3	19	12	100	100	5	*1
13	19.5	19	13	100	108	5	*1
14	20.8	19	14	100	112	5	*1
17	24.5	19	17	100	140	5	*1

*1 C-Ring=C31, Pin/O-Ring=A31/B31 → P268-269

13145MG-100 / -150 / -200

Extra Long Socket with Magnet
Schaftsteckschlüssel mit Magnet
Douilles, série allongée, avec aimant

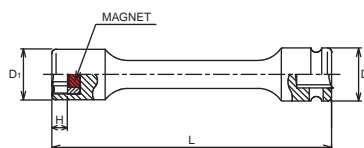

Impact Sockets

Impact Steckschlüssel

Douilles Impact

3/8"

Z-SERIES
HAND
TITANIUM
SCREWDRIVERS ACCESSORIES
IMPACT
SLEEVE-DRIVE
PROTECTOR
INDUSTRIAL
AUTOMOTIVE
MOTORCYCLE
CONSTRUCTION
SPARE PART

13145M-100 (12P) / -150 (12P) / -200 (12P)

Extra long 12-Point Sockets
Extra lange 12-kant Steckschlüssel
Douilles, série allongée 12 pans

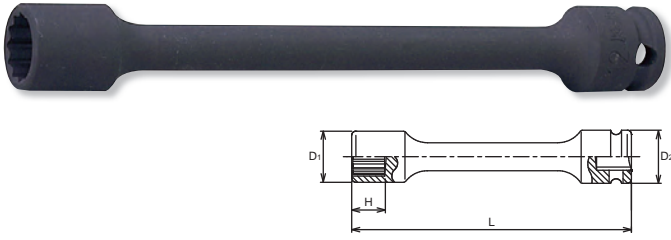

13145M-100 (12P) (mm)	D ₁ (mm)	D ₂ (mm)	H (mm)	L (mm)	(g)	(pcs.)	
10	15.8	19	10	100	91	5	*1
12	18.3	19	12	100	100	5	*1

13145M-150 (12P) (mm)	D ₁ (mm)	D ₂ (mm)	H (mm)	L (mm)	(g)	(pcs.)	
10	15.8	19	10	150	120	5	*1
12	18.3	19	12	150	128	5	*1

13145M-200 (12P) (mm)	D ₁ (mm)	D ₂ (mm)	H (mm)	L (mm)	(g)	(pcs.)	
10	15.8	19	10	200	151	5	*1
12	18.3	19	12	200	159	5	*1

*1 C-Ring=C31, Pin/O-Ring=A31/B31 → P268-269

13146M-150 / -200 / -250

Extra Long Universal Sockets
Schaftsteckschlüssel mit Gelenk
Douilles, articulées, série allongée

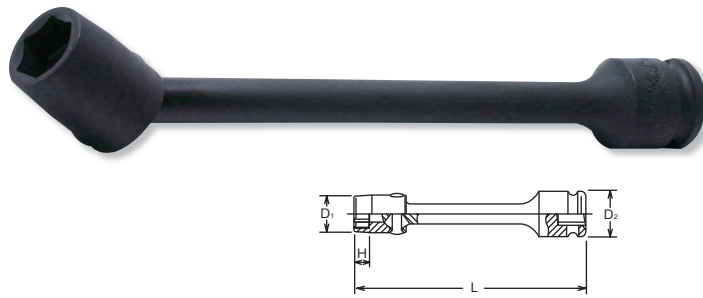

13146M-150 (mm)	D ₁ (mm)	D ₂ (mm)	H (mm)	L (mm)	(g)	(pcs.)	
8	12	19	6	150	128	5	*1
10	14.3	19	7	150	131	5	*1
12	18	19	8	150	133	5	*1
13	19.3	19	8.5	150	132	5	*1
14	20	19	9	150	132	5	*1

13146M-200 (mm)	D ₁ (mm)	D ₂ (mm)	H (mm)	L (mm)	(g)	(pcs.)	
8	12	19	6	200	159	5	*1
10	14.3	19	7	200	162	5	*1
12	18	19	8	200	164	5	*1
13	19.3	19	8.5	200	163	5	*1
14	20	19	9	200	163	5	*1

13146M-250 (mm)	D ₁ (mm)	D ₂ (mm)	H (mm)	L (mm)	(g)	(pcs.)	
8	12	19	6	250	190	5	*1
10	14.3	19	7	250	193	5	*1
12	18	19	8	250	195	5	*1
13	19.3	19	8.5	250	194	5	*1
14	20	19	9	250	194	5	*1

*1 C-Ring=C31, Pin/O-Ring=A31/B31 → P268-269

13147M-150 / -200

Extra Long Universal Inhex Sockets
Schaftsteckschlüssel mit Aussensechskant Gelenk
Douilles, articulées, à 6-pans mâle, série allongée

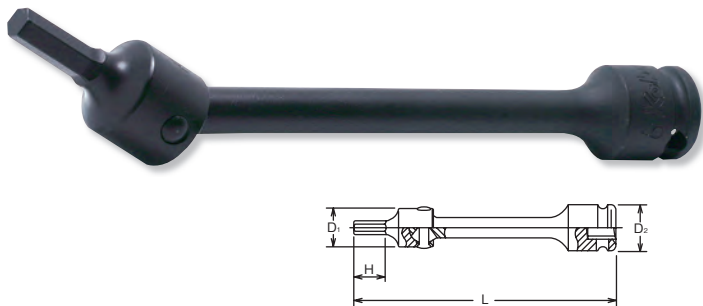

13147M-150 (mm)	D ₁ (mm)	D ₂ (mm)	H (mm)	L (mm)	(g)	(pcs.)	
4	21	19	15	150	125	5	*1
5	21	19	15	150	128	5	*1
6	21	19	15	150	132	5	*1
8	21	19	15	150	136	5	*1
10	21	19	15	150	140	5	*1

13147M-200 (mm)	D ₁ (mm)	D ₂ (mm)	H (mm)	L (mm)	(g)	(pcs.)	
4	21	19	15	200	156	5	*1
5	21	19	15	200	159	5	*1
6	21	19	15	200	163	5	*1
8	21	19	15	200	167	5	*1
10	21	19	15	200	171	5	*1

*1 C-Ring=C31, Pin/O-Ring=A31/B31 → P268-269

13012M-52 (mm)	D (mm)	H ₁ (mm)	H ₂ (mm)	L (mm)	(g)	(pcs.)	
3	18	10	34	52	33	10	*1
4	18	15.5	34	52	35	10	*1
5	18	15.5	34	52	35	10	*1
6	18	15.5	34	52	39	10	*1
7	18	15.5	34	52	44	10	*1
8	21	15.5	34	52	60	10	*2
10	21	15.5	34	52	70	10	*2
12	21	15.5	34	52	79	10	*2
14	21	15.5	34	52	92	10	*2

*1 C-Ring=C31, Pin/O-Ring=A31/B31

*2 C-Ring=C32, Pin/O-Ring=A32/B32 → P268-269

RS13012M/8-L52	8 Pieces Set/Rail 200mm	(g)
4, 5, 6, 7, 8, 10, 12, 14		492

13025-50 (T)	D (mm)	H (mm)	L (mm)	(g)	(pcs.)	
T20	19	23.5	50	35	10	*1
T25	19	23.5	50	35	10	*1
T27	19	23.5	50	35	10	*1
T30	19	23.5	50	35	10	*1
T40	19	23.5	50	39	10	*1
T45	19	23.5	50	60	10	*1
T50	19	23.5	50	70	10	*1
T55	22	23.5	50	79	10	*2

13025-90 (T)	D (mm)	H (mm)	L (mm)	(g)	(pcs.)	
T20	19	63.5	90	43	10	*1
T25	19	63.5	90	45	10	*1
T27	19	63.5	90	47	10	*1
T30	19	63.5	90	50	10	*1
T40	19	63.5	90	58	10	*1
T45	19	63.5	90	66	10	*1
T50	19	63.5	90	80	10	*1
T55	22	63.5	90	120	10	*2

*1 C-Ring=C31, Pin/O-Ring=A31/B31

*2 C-Ring=C32, Pin/O-Ring=A32/B32 → P268-269

RS13025/8-L50	8 Pieces Set/Rail 200mm	(g)
T20, T25, T27, T30, T40, T45, T50, T55		380

13134	D ₁ (mm)	D ₂ (mm)	L (mm)	(g)	(pcs.)	
	24	22	32	70	10	*2

*2 C-Ring=C32, Pin/O-Ring=A32/B32 → P268-269

For DIN3126 E11.2 Bits
Für DIN3126 E11.2 Bits
Pour DIN3126 E11.2 Embouts

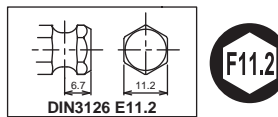

16134-SC

Replacement Screw : M8x6, ● 4mm
Ersatzschraube : M8x6, ● 4mm
Vis de remplacement : M8x6, ● 4mm

13142-F11.2	D ₁ (mm)	D ₂ (mm)	L (mm)	(g)	(pcs.)	
	18.9	22	46	116	10	*2

*2 C-Ring=C32, Pin/O-Ring=A32/B32 → P268-269

For DIN3126 E11.2 Bits
Für DIN3126 E11.2 Bits
Pour DIN3126 E11.2 Embouts

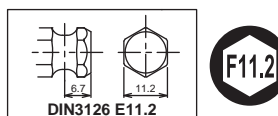

⚠ You may not hold the sliding part while moving to avoid heating up by friction and reduction by wear.

Bitte das gleitende Teil während der Bewegung nicht festhalten, um eine Erhitzung durch Reibung und durch Verschleiß zu vermeiden.

Vous ne devez pas tenir la partie coulissante pendant le mouvement, afin d'éviter un échauffement dû à la friction et à l'usure.

13012M-52

Hex Sockets
Steckschlüssel für Innensechskant-Schrauben
Douilles tournevis pour vis 6-pans creux

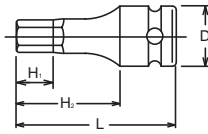

RS13012M/8-L52

Socket Set on Rail
Steckschlüsselsatz auf Schiene
Jeu de douilles sur rail



13025-50 / -90

TORX® Bit Sockets
TORX® Bit-Steckschlüssel
Douilles tournevis, TORX®

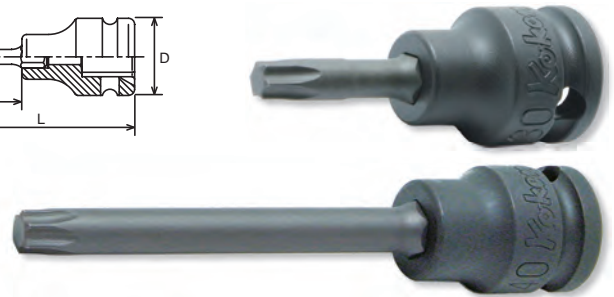
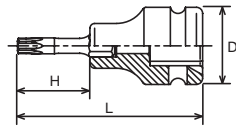

RS13025/8-L50

Socket Set on Rail
Steckschlüsselsatz auf Schiene
Jeu de douilles sur rail



13134

Impact Bit Holder
Impact Klingenhalter
Porte embouts Impact

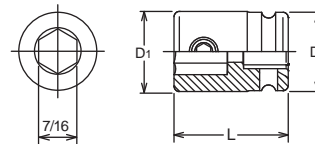

13142-F11.2

Impact Bit Holder (Quick Release)
Impact Klingenhalter (Quick Release)
Porte embouts Impact (Quick Release)

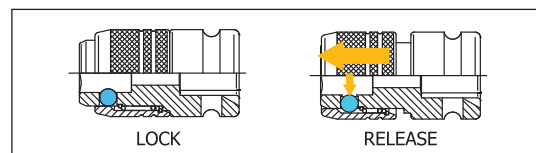
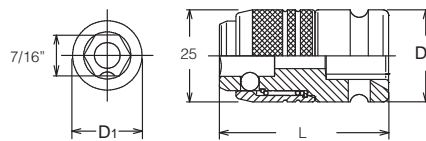

Impact Sockets Impact Steckschlüssel Douilles Impact

3/8"

183H-35 / -75 / -150

Hex Bits
Sechskant Bits
Embout, 6 pans creux

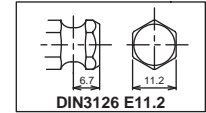
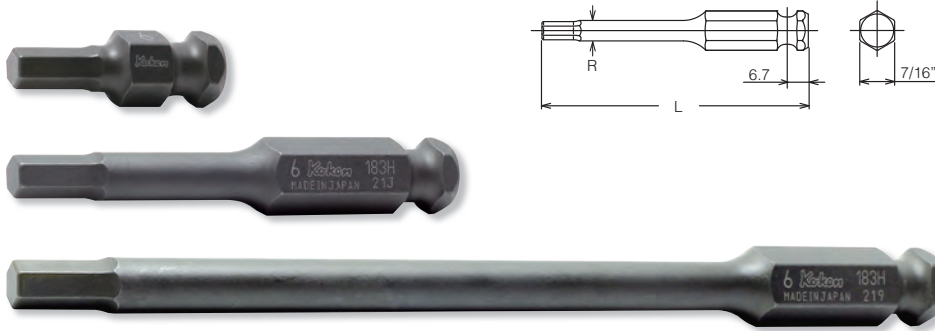

183H-35 (mm)	L (mm)	(g)	(pcs.)
3	35	15	10
4	35	15	10
5	35	15	10
6	35	18	10
7	35	19	10
8	35	20	10
9	35	23	10
10	35	26	10
11	35	28	10
12	35	30	10
14	35	35	10
16	35	47	10
17	35	50	10
18	35	53	10
19	35	56	10

183H-35 (inch)	L (mm)	(g)	(pcs.)
3/16	35	15	10
7/32	35	16	10
1/4	35	18	10
5/16	35	20	10
3/8	35	26	10
7/16	35	28	10
1/2	35	38	10

183H-75 (mm)	L (mm)	R (mm)	(g)	(pcs.)
3	75	6	34	10
4	75	6	35	10
5	75	6.5	36	10
6	75	7.5	39	10
7	75	8.5	44	10
8	75	9.5	47	10
10	75	-	57	10
11	75	-	60	10
12	75	-	65	10
14	75	-	79	10

183H-150 (mm)	L (mm)	R (mm)	(g)	(pcs.)
4	150	6	51	10
5	150	6.5	55	10
6	150	7.5	65	10
8	150	9.5	87	10
10	150	-	118	10
12	150	-	136	10

⚠ The items with ⚠ have larger output sizes than 7/16" Input drive.
Due to this design the maximum output torque rating is less than standard.
Die mit ⚠ gekennzeichneten Artikel haben größere Abtriebsgrößen als der 7/16" Antrieb.
Aufgrund dieser Konstruktion ist das maximale Abtriebsdrehmoment geringer als der Standardwert.
Les articles marqués d'un ⚠ ont des tailles de sortie plus importantes que l'entraînement d'entrée 7/16".
En raison de cette conception, le couple de sortie maximum est inférieur au couple standard.

183H-75B / -150B

Ball-point Hex Bits
Sechskant Bits mit Kugelkopf
Embout hexagonaux à tête sphérique

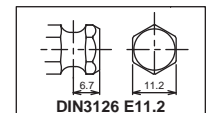
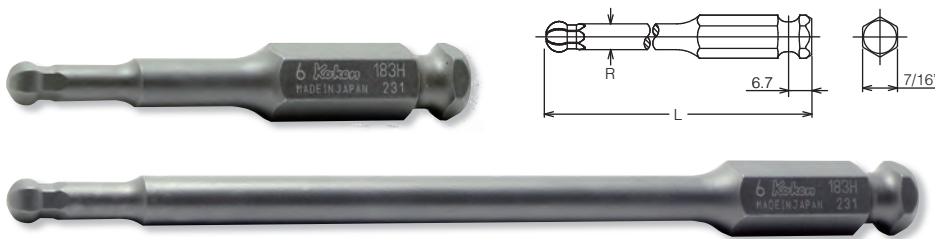

183H-75B (mm)	L (mm)	R (mm)	(g)	(pcs.)
New 6B	75	5.7	39	10
New 8B	75	7.7	44	10
New 10B	75	9.7	49	10
New 12B	75	11.7	72	10

183H-150B (mm)	L (mm)	R (mm)	(g)	(pcs.)
New 6B	150	5.7	65	10
New 8B	150	7.7	71	10
New 10B	150	9.7	92	10
New 12B	150	11.7	135	10

3/8"

Impact Sockets
Impact Steckschlüssel
Douilles Impact

Z-SERIES
HAND
TITANIUM
ACCESSORIES
SCREWDRIVERS
IMPACT
SLEEVE-DRIVE
PROTECTOR
INDUSTRIAL
AUTOMOTIVE
MOTORCYCLE
CONSTRUCTION
SPARE PART

183T-35 (T)	L (mm)	(g)	(pcs.)
T25	35	18	10
T30	35	18	10
T40	35	20	10
T45	35	22	10
T50	35	26	10
T55	35	30	10
T60	35	38	10

183T-35 / -75 / -150 (T)

TORX® Bits
TORX® Bits
Embouts, TORX®

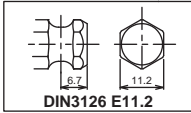
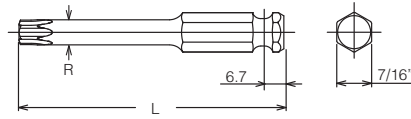

183T-75 (T)	L (mm)	R (mm)	(g)	(pcs.)
T25	75	6	33	10
T27	75	6	33	10
T30	75	6	35	10
T40	75	6.9	37	10
T45	75	8	41	10
T50	75	9	45	10
T55	75	11.4	55	10
T60	75	13.5	67	10

183T-150 (T)	L (mm)	R (mm)	(g)	(pcs.)
T30	150	6	50	10
T40	150	6.9	58	10
T45	150	8	70	10
T50	150	9	82	10
T55	150	11.4	113	10
T60	150	13.5	148	10

183T-35 (IP)	L (mm)	(g)	(pcs.)
30IP	35	18	10
40IP	35	20	10
45IP	35	22	10
50IP	35	26	10
55IP	35	30	10
60IP	35	38	10

183T-35 / -75 (IP)

TORXPLUS® Bits
TORXPLUS® Bits
Embouts TORXPLUS®

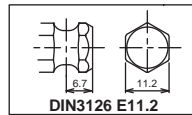
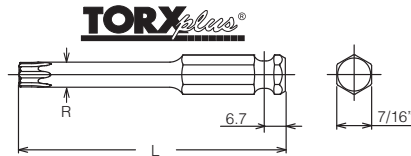

183T-75 (IP)	L (mm)	R (mm)	(g)	(pcs.)
30IP	75	6	35	10
40IP	75	6.8	37	10
45IP	75	8	41	10
50IP	75	9	45	10
55IP	75	11.4	56	10
60IP	75	13.5	67	10

183X-35 (XZN)	L (mm)	(g)	(pcs.)
M 4	35	18	10
M 5	35	18	10
M 6	35	20	10
M 8	35	22	10
M10	35	26	10
M12	35	30	10
M14	35	38	10

183X-35 / -75 / -150 (XZN)

XZN Bits
XZN Bits
Embouts, XZN

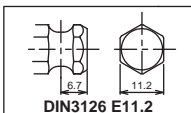
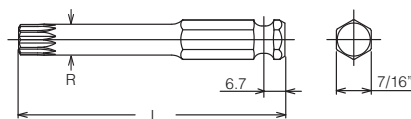

183X-75 (XZN)	L (mm)	R (mm)	(g)	(pcs.)
M 4	75	6	34	10
M 5	75	6	34	10
M 6	75	6.2	36	10
M 8	75	7.4	39	10
M10	75	9.8	54	10
M12	75	11.7	57	10
M14	75	13.5	67	10

183X-150 (XZN)	L (mm)	R (mm)	(g)	(pcs.)
M 5	150	6	50	10
M 6	150	6.2	53	10
M 8	150	7.4	64	10
M10	150	9.8	93	10
M12	150	11.7	121	10
M14	150	13.5	151	10

⚠ The items with ⚠ have larger output sizes than 7/16" Input drive.
Due to this design the maximum output torque rating is less than standard.

Die mit ⚠ gekennzeichneten Artikel haben größere Abtriebsgrößen als der 7/16" Antrieb.
Aufgrund dieser Konstruktion ist das maximale Abtriebsdrehmoment geringer als der Standardwert.
Les articles marqués d'un ⚠ ont des tailles de sortie plus importantes que l'entraînement d'entrée 7/16". En raison de cette conception, le couple de sortie maximum est inférieur au couple standard.

Z-SERIES
HAND
TITANIUM
SCREWDRIVERS ACCESSORIES
IMPACT
SLEEVE-DRIVE
PROTECTOR
INDUSTRIAL
AUTOMOTIVE
MOTORCYCLE
CONSTRUCTION
SPARE PART

13134M-52 / -92



Bit Holder complete with Bit, Inhex
Klingenhalter komplett mit Klinge, Innensechskant
Porte embouts avec bit 6-pans creux

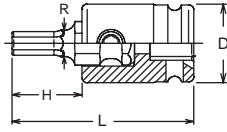

13134T-52 / -92 (T)



Bit Holder complete with TORX® Bit
Klingenhalter, komplett mit TORX® Klinge
Porte embouts avec bit TORX®

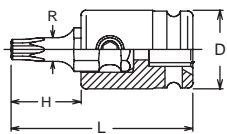

13134T-52 / -92 (IP)



Bit Holder complete with TORXPLUS® Bit
Klingenhalter, komplett mit TORXPLUS® Klinge
Porte embouts avec bit TORXPLUS®

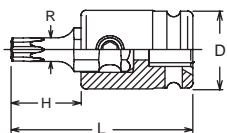

13134X-52 / -92 (XZN)



Bit Holder complete with XZN Bit
Klingenhalter, komplett mit XZN Klinge
Porte embouts avec bit XZN

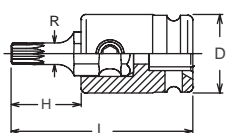

⚠ The items with ⚠ have larger output sizes than 7/16" Input drive.
Due to this design the maximum output torque rating is less than standard.

Die mit ⚠ gekennzeichneten Artikel haben größere Abtriebsgrößen als der 7/16" Antrieb.
Aufgrund dieser Konstruktion ist das maximale Abtriebsdrehmoment geringer als der Standardwert.

Les articles marqués d'un ⚠ ont des tailles de sortie plus importantes que l'entraînement d'entrée 7/16".
En raison de cette conception, le couple de sortie maximum est inférieur au couple standard.

13134M-52 (mm)	D (mm)	H (mm)	L (mm)	R (mm)	(g)	(pcs.)	⚠
3	22	20	52	6	85	10	*2
4	22	20	52	6	85	10	*2
5	22	20	52	6.5	85	10	*2
6	22	20	52	7.5	88	10	*2
8	22	20	52	9.5	90	10	*2
10	22	20	52	-	96	10	*2
12	22	20	52	-	100	10	*2 ⚠
14	22	20	52	-	105	10	*2 ⚠

13134M-92 (mm)	D (mm)	H (mm)	L (mm)	R (mm)	(g)	(pcs.)	⚠
3	22	60	92	6	104	10	*2
4	22	60	92	6	105	10	*2
5	22	60	92	6.5	106	10	*2
6	22	60	92	7.5	109	10	*2
8	22	60	92	9.5	117	10	*2
10	22	60	92	-	127	10	*2
12	22	60	92	-	135	10	*2 ⚠
14	22	60	92	-	149	10	*2 ⚠

*2 C-Ring=C32, Pin/O-Ring=A32/B32 → P268-269

13134T-52 (T)	D (mm)	H (mm)	L (mm)	R (mm)	(g)	(pcs.)	⚠
T30	22	20.6	52	6	88	10	*2
T40	22	20.6	52	6.9	90	10	*2
T45	22	20.6	52	8	92	10	*2
T50	22	20.6	52	9	96	10	*2
T55	22	20.6	52	11.4	100	10	*2
T60	22	20.6	52	13.5	108	10	*2 ⚠

13134T-92 (T)	D (mm)	H (mm)	L (mm)	R (mm)	(g)	(pcs.)	⚠
T30	22	20.6	92	6	105	10	*2
T40	22	20.6	92	6.9	107	10	*2
T45	22	20.6	92	8	111	10	*2
T50	22	20.6	92	9	115	10	*2
T55	22	20.6	92	11.4	125	10	*2
T60	22	20.6	92	13.5	137	10	*2 ⚠

*2 C-Ring=C32, Pin/O-Ring=A32/B32 → P268-269

13134T-52 (IP)	D (mm)	H (mm)	L (mm)	R (mm)	(g)	(pcs.)	⚠
30IP	22	20.6	52	6	88	10	*2
40IP	22	20.6	52	6.8	90	10	*2
45IP	22	20.6	52	8	92	10	*2
50IP	22	20.6	52	9	96	10	*2
55IP	22	20.6	52	11.4	100	10	*2
60IP	22	20.6	52	13.5	108	10	*2 ⚠

13134T-92 (IP)	D (mm)	H (mm)	L (mm)	R (mm)	(g)	(pcs.)	⚠
30IP	22	20.6	92	6	105	10	*2
40IP	22	20.6	92	6.8	107	10	*2
45IP	22	20.6	92	8	111	10	*2
50IP	22	20.6	92	9	115	10	*2
55IP	22	20.6	92	11.4	126	10	*2
60IP	22	20.6	92	13.5	139	10	*2 ⚠

*2 C-Ring=C32, Pin/O-Ring=A32/B32 → P268-269

13134X-52 (XZN)	D (mm)	H (mm)	L (mm)	R (mm)	(g)	(pcs.)	⚠
M 5	22	20.6	52	6	88	10	*2
M 6	22	20.6	52	6.2	90	10	*2
M 8	22	20.6	52	7.4	92	10	*2
M10	22	20.6	52	9.8	96	10	*2
M12	22	20.6	52	11.7	100	10	*2
M14	22	20.6	52	13.5	108	10	*2 ⚠

13134X-92 (XZN)	D (mm)	H (mm)	L (mm)	R (mm)	(g)	(pcs.)	⚠
M 5	22	20.6	92	6	104	10	*2
M 6	22	20.6	92	6.2	106	10	*2
M 8	22	20.6	92	7.4	109	10	*2
M10	22	20.6	92	9.8	124	10	*2
M12	22	20.6	92	11.7	129	10	*2
M14	22	20.6	92	13.5	139	10	*2 ⚠

*2 C-Ring=C32, Pin/O-Ring=A32/B32 → P268-269

	D ₁ (mm)	D ₂ (mm)	L (mm)	(g)	(pcs.)	
13139-1/4	11	19	30	32	10	*1

*1 C-Ring=C31,Pin/O-Ring=A31/B31 → P268-269

For DIN3126 C6.3 Bits
Für DIN3126 C6.3 Bits
Pour DIN3126 C6.3 Embouts

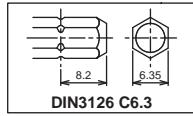

13139 ○ Bit Holder Klingenhalter Porte-embout

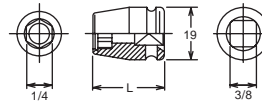

	D ₁ (mm)	D ₂ (mm)	L (mm)	(g)	(pcs.)	
13140-5/16	14	19	30	32	10	*1

*1 C-Ring=C31,Pin/O-Ring=A31/B31 → P268-269

For DIN3126 C8 Bits
Für DIN3126 C8 Bits
Pour DIN3126 C8 Embouts

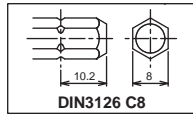

13140 ○ Bit Holder Klingenhalter Porte-embout

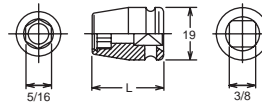

	D ₁ (mm)	D ₂ (mm)	L (mm)	(g)	(pcs.)	
13142-D6.3	16	19	45	60	10	*1

*1 C-Ring=C31,Pin/O-Ring=A31/B31 → P268-269

For DIN3126 C6.3 Bits
Für DIN3126 C6.3 Bits
Pour DIN3126 C6.3 Embouts

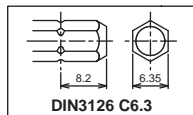

13142-D6.3 ○ Impact Bit Holder (Quick Release) Impact Kingenhalter (Schnellwechselfutter) ⚠ Porte embout Impact (mandrin autoserrant)

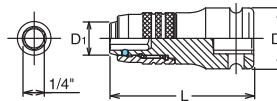

⚠ You may not hold the sliding part while moving to avoid heating up by friction and reduction by wear.

Bitte das gleitende Teil während der Bewegung nicht festhalten, um eine Erhitzung durch Reibung und durch Verschleiß zu vermeiden.

Vous ne devez pas tenir la partie coulissante pendant le mouvement, afin d'éviter un échauffement dû à la friction et à l'usure.

	D ₁ (mm)	D ₂ (mm)	L (mm)	(g)	(pcs.)	
13142-F6.3	16.5	19	45	60	10	*1

*1 C-Ring=C31,Pin/O-Ring=A31/B31 → P268-269

For DIN3126 E6.3 Bits
Für DIN3126 E6.3 Bits
Pour DIN3126 E6.3 Embouts

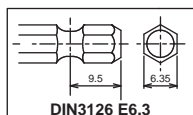

13142-F6.3 ○ Impact Bit Holder (Quick Release) Impact Kingenhalter (Schnellwechselfutter) ⚠ Porte embout Impact (mandrin autoserrant)

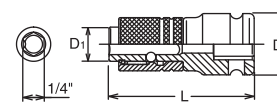

⚠ You may not hold the sliding part while moving to avoid heating up by friction and reduction by wear.
Bitte das gleitende Teil während der Bewegung nicht festhalten, um eine Erhitzung durch Reibung und durch Verschleiß zu vermeiden.

Vous ne devez pas tenir la partie coulissante pendant le mouvement, afin d'éviter un échauffement dû à la friction et à l'usure.

Lock & Quick Release

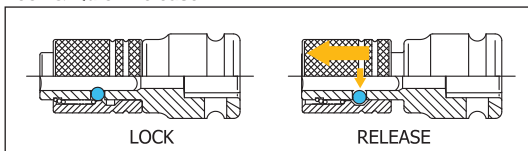

Impact Sockets Impact Steckschlüssel Douilles Impact

3/8"

Z-SERIES
HAND
TITANIUM
SCREWDRIVERS ACCESSORIES
IMPACT
SLEEVE-DRIVE
PROTECTOR
INDUSTRIAL
AUTOMOTIVE
MOTORCYCLE
CONSTRUCTION
SPARE PART

13760 Extension Bars Verlängerungen Rallonges

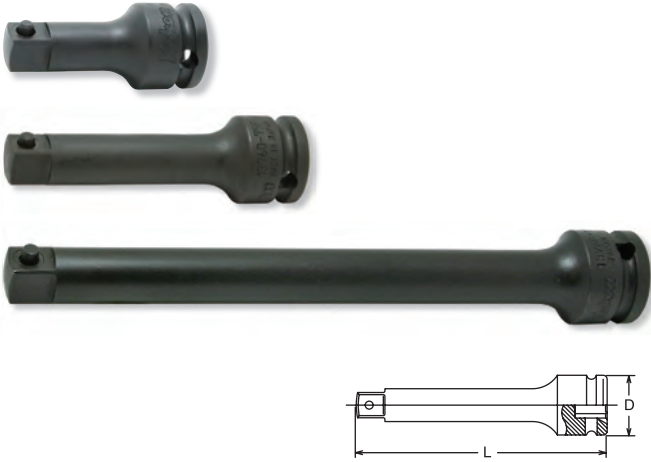

	TYPE	D (mm)	L (mm)	(g)	(pcs.)	
13760-50P	Pin	22	50	70	10	*2
13760-75P	Pin	22	75	95	10	*2
13760-100P	Pin	22	100	115	10	*2
13760-125P	Pin	22	125	140	5	*2
13760-150P	Pin	22	150	165	5	*2
13760-200P	Pin	22	200	215	5	*2
13760-250P	Pin	22	250	260	5	*2

	TYPE	D (mm)	L (mm)	(g)	(pcs.)	
13760-50	Hole	22	50	70	10	*2
13760-75	Hole	22	75	95	10	*2
13760-100	Hole	22	100	115	10	*2
13760-125	Hole	22	125	140	5	*2
13760-150	Hole	22	150	165	5	*2
13760-200	Hole	22	200	215	5	*2
13760-250	Hole	22	250	260	5	*2

*2 C-Ring=C32, Pin/O-Ring=A32/B32 → P268-269

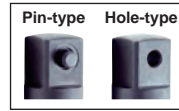

13333AL Adaptor (Quick Release) Verbindungsstück (Quick Release) Adaptateur (Quick Release)



	L (mm)	(g)	(pcs.)	
13333AL	45	62	10	*1

*1 C-Ring=C31, Pin/O-Ring=A31/B31 → P268-269

Lock & Quick Release

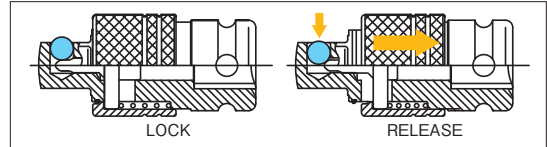

⚠ You may not hold the sliding part while moving to avoid heating up by friction and reduction by wear.

Bitte das gleitende Teil während der Bewegung nicht festhalten, um eine Erhitzung durch Reibung und durch Verschleiß zu vermeiden.

Vous ne devez pas tenir la partie coulissante pendant le déplacement afin d'éviter l'échauffement par frottement et la réduction par usure la réduction par l'usure.

13333WA Angle-Adaptor with Return Spring Winkeladapter mit Rückholfeder Adaptateur angulaire avec ressort de rappel

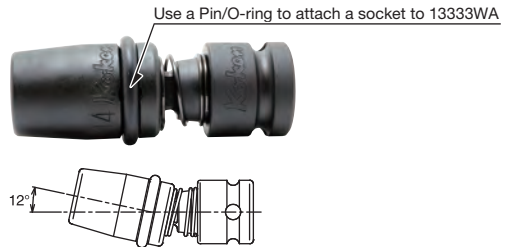

	D (mm)	L (mm)	(g)	(pcs.)	
13333WA	19	35	36	10	*1

*1 C-Ring=C31, Pin/O-Ring=A31/B31 → P268-269

⚠ It is strongly recommended to check the tightening torque for applications with the adaptors 13333WA and 14444WA, as the reduced square drive reduces the overall torques.

Es wird dringend empfohlen, bei Anwendungen mit den Adaptern 13333WA und 14444WA das Anzugsmoment zu überprüfen, da der reduzierte Vierkanttrieb die Gesamtdrehmomente verringert.

Il est fortement recommandé de vérifier le couple de serrage pour les applications avec les adaptateurs 13333WA et 14444WA, car l'entraînement carré réduit diminue les couples totaux.

	TYPE	L (mm)	(g)	(pcs.)	
	13770-P Pin	56	110	10	*2
New	13770-B Ball	56	110	10	*2
	13770 Hole	56	110	10	*2
	13771-P Pin	48	92	10	*2
New	13771-B Ball	48	92	10	*2
	13771 Hole	48	92	10	*2

*2 C-Ring=C32, Pin/O-Ring=A32/B32 → P268-269

Our ball joints are spring-loaded and can therefore be adjusted to an angle of max. 30°.

Unsere Kugelgelenke sind federbelastet dadurch sind sie auf einen Winkel von max 30° einstellbar.

Nos joints à rotule sont à ressort et peuvent donc être réglés jusqu'à un angle de 30° maximum.

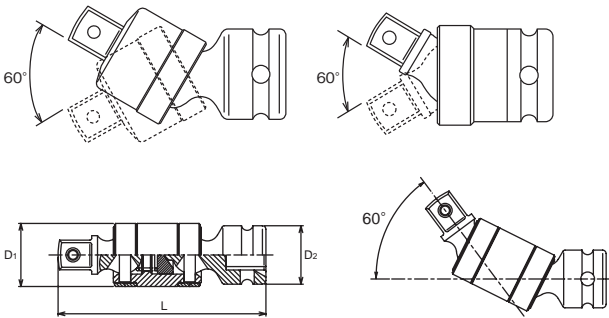

	TYPE	D ₁ (mm)	D ₂ (mm)	L (mm)	(g)	(pcs.)	
	13772-P Pin	22	19	75	120	5	*1
	13772-B Hole	22	19	75	120	5	*1

*1 C-Ring=C31, Pin/O-Ring=A31/B31 → P268-269

Make sure sockets hold bolts or nuts before operation.

Vergewissern Sie sich vor dem Gebrauch, dass der Steckschlüssel die Schraube sicher umfasst hat.

Avant la manipulation, il est nécessaire de s'assurer que la douille renferme parfaitement la vis.

⚠ 13772 and 14772 have less load capacity than standard. In the interest of your safety always use properly.

Die Doppelgelenke 13772 und 14772 haben eine geringere Belastbarkeit als das Standardgelenk. Im Interesse Ihrer Sicherheit sollten Sie sie immer richtig verwenden.

Les doubles articulations 13772 et 14772 ont une capacité de charge inférieure à celle de l'articulation standard. Pour votre propre sécurité, vous devez toujours les utiliser correctement.



UNIVERSAL DOUBLE JOINT

13770 Universal Joint Gelenk-Einsatz Joint articulé

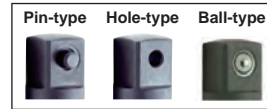
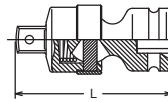

13771 Universal Joint Gelenk-Einsatz Joint articulé

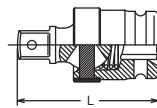

13772 Universal Double Joint Doppelgelenk-Einsatz Joint articulé double

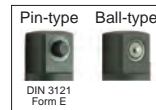

13322A Adaptor Verbindungsstück Réducteur

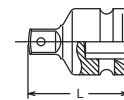

⚠ Adapting down from bigger square drive to smaller square drive may lead to excessive torque load and possibly cause breakage. Always stay within safe torque of the smaller square drive.

Die mit ⚠ gekennzeichneten Artikel können bei Überbelastung zu Bruch gehen. Aus Gründen Ihrer eigenen Sicherheit sollten die betreffenden Werkzeuge nie ruckartig, sondern nach und nach belastet werden, um Bruch und damit verbundene mögliche Verletzungen zu vermeiden.

Il est possible d'appliquer aux articles marqués ⚠ des couples de serrage susceptibles d'occasionner leur rupture. Pour votre propre sécurité, veuillez toujours appliquer la charge d'une manière uniforme et progressive. Ceci pour éviter ruptures et accidents.

	TYPE	(sq.)	(sq.)	L (mm)	(g)	(pcs.)	
	13322A-P Pin	3/8"	1/4"	27	25	10	*1
New	13322A-B Ball	3/8"	1/4"	27	25	10	*1
	13322A Hole	3/8"	1/4"	27	25	10	*1

*1 C-Ring=C31, Pin/O-Ring=A31/B31 → P268-269

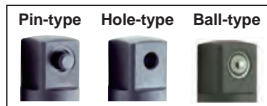

	TYPE	(sq.)	(sq.)	L (mm)	(g)	(pcs.)	
	13344A-P Pin	3/8"	1/2"	32.5	53	10	*2
New	13344A-B Ball	3/8"	1/2"	32.5	53	10	*2
	13344A Hole	3/8"	1/2"	32.5	53	10	*2

*2 C-Ring=C32, Pin/O-Ring=A32/B32 → P268-269

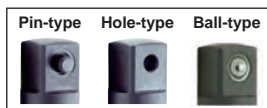

13344A Adaptor Verbindungsstück Augmentateur

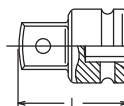

13242M Socket Set Steckschlüssel Satz Jeu de clés à douilles



13242M	11 Pieces Set/△=1,140g
METAL CASE:W310xH90xT48mm	
Sockets	
13400M 6-pt. Sockets	
9, 10, 11, 12, 13, 14, 15, 16, 17, 18, 19	

Impact Sockets Impact Steckschlüssel Douilles Impact

1/2"

Z-SERIES
HAND
TITANIUM
SCREWDRIVERS ACCESSORIES
IMPACT
SLEEVE-DRIVE
PROTECTOR
INDUSTRIAL
AUTOMOTIVE
MOTORCYCLE
CONSTRUCTION
SPARE PART

14400M / 14400A

6-point Sockets
6-kant Steckschlüssel
Douilles 6-pans

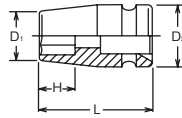

14400A (inch)	D ₁ (mm)	D ₂ (mm)	H (mm)	L (mm)	(g)	(pcs.)	
1/4	12	25	5	38	80	10	*1
5/16	14.5	25	6	38	85	10	*1
3/8	17	25	7	38	85	10	*1
7/16	18.2	25	8	38	85	10	*1
1/2	20.7	25	10	38	85	10	*1
9/16	22	25	10	38	85	10	*1
19/32	23.2	30	11	38	130	10	*2
5/8	24.5	30	11	38	130	10	*2
11/16	25.7	30	12	38	130	10	*2
3/4	28.2	30	13	38	125	10	*2
13/16	30.7	30	14	38	120	10	*2
7/8	32	30	14	38	130	10	*2
15/16	34.5	30	14	38	135	10	*2
1	35.7	30	14	38	135	10	*2
1. 1/16	38.2	30	16	40	160	10	*2
1. 1/8	40.7	30	17	42	190	10	*2
1. 3/16	42	30	17	42	190	10	*2
1. 1/4	44.5	30	18	42	216	10	*2
1. 5/16	45.7	30	19	46	260	5	*2
1. 3/8	47	30	19	46	263	5	*2
1. 1/2	52	30	20	53	365	5	*2

*1 C-Ring=C41, Pin/O-Ring=A41/B41 → P268-269
*2 C-Ring=C42, Pin/O-Ring=A42/B42

14400M (mm)	D ₁ (mm)	D ₂ (mm)	H (mm)	L (mm)	(g)	(pcs.)	
8	14.5	25	6	38	85	10	*1
9	15.7	25	7	38	85	10	*1
10	17	25	7	38	85	10	*1
11	18.2	25	8	38	85	10	*1
12	19.5	25	9	38	85	10	*1
13	20.7	25	10	38	85	10	*1
14	22	25	10	38	85	10	*1
15	23.2	30	11	38	130	10	*2
16	24.5	30	11	38	130	10	*2
17	25.7	30	12	38	130	10	*2
18	27	30	13	38	130	10	*2
19	28.2	30	13	38	125	10	*2
20	29.5	30	13	38	127	10	*2
21	30.7	30	14	38	120	10	*2
22	32	30	14	38	130	10	*2
23	33.2	30	14	38	130	10	*2
24	34.5	30	14	38	135	10	*2
25	35.7	30	14	38	135	10	*2
26	37	30	14	38	160	10	*2
27	38.2	30	16	40	160	10	*2
28	39.5	30	16	40	170	10	*2
29	40.7	30	17	42	190	10	*2
30	42	30	17	42	190	10	*2
31	43.2	30	17	42	213	10	*2
32	44.5	30	18	42	216	10	*2
33	45.7	30	19	46	260	5	*2
34	47	30	19	46	263	5	*2
35	48.2	30	19	46	275	5	*2
36	49.5	30	20	46	285	5	*2
38	52	30	20	53	360	5	*2
41	55.7	30	21	55	411	2	*2

*1 C-Ring=C41, Pin/O-Ring=A41/B41 → P268-269
*2 C-Ring=C42, Pin/O-Ring=A42/B42

14405M / 14405A

12-point Sockets
12-kant Steckschlüssel
Douilles 12-pans

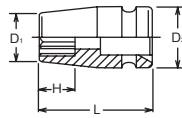

14405A (inch)	D ₁ (mm)	D ₂ (mm)	H (mm)	L (mm)	(g)	(pcs.)	
5/16	14.5	25	6	38	85	10	*1
3/8	17	25	7	38	85	10	*1
7/16	18.2	25	8	38	85	10	*1
1/2	20.7	25	10	38	85	10	*1
9/16	22	25	10	38	85	10	*1
5/8	24.5	30	11	38	130	10	*2
11/16	25.7	30	12	38	130	10	*2
3/4	28.2	30	13	38	125	10	*2
13/16	30.7	30	14	38	120	10	*2
7/8	32	30	14	38	130	10	*2
15/16	34.5	30	14	38	135	10	*2
1	35.7	30	14	38	135	10	*2
1. 1/16	38.2	30	16	40	160	10	*2
1. 1/8	40.7	30	17	42	190	10	*2
1. 3/16	42	30	17	42	190	10	*2
1. 1/4	44.5	30	18	42	216	10	*2
1. 5/16	45.7	30	19	46	260	5	*2
1. 3/8	47	30	19	46	263	5	*2
1. 1/2	52	30	20	53	365	5	*2

*1 C-Ring=C41, Pin/O-Ring=A41/B41 → P268-269
*2 C-Ring=C42, Pin/O-Ring=A42/B42

14405M (mm)	D ₁ (mm)	D ₂ (mm)	H (mm)	L (mm)	(g)	(pcs.)	
8	14.5	25	6	38	85	10	*1
9	15.7	25	7	38	85	10	*1
10	17	25	7	38	85	10	*1
11	18.2	25	8	38	84	10	*1
12	19.5	25	9	38	84	10	*1
13	20.7	25	10	38	84	10	*1
14	22	25	10	38	84	10	*1
15	23.2	30	11	38	130	10	*2
16	24.5	30	11	38	127	10	*2
17	25.7	30	12	38	128	10	*2
18	27	30	13	38	130	10	*2
19	28.2	30	13	38	125	10	*2
20	29.5	30	13	38	127	10	*2
21	30.7	30	14	38	120	10	*2
22	32	30	14	38	130	10	*2
23	33.2	30	14	38	132	10	*2
24	34.5	30	14	38	133	10	*2
26	37	30	14	38	147	10	*2
27	38.2	30	16	40	157	10	*2
28	39.5	30	16	40	170	10	*2
30	42	30	17	42	190	10	*2
32	44.5	30	18	42	216	10	*2
36	49.5	30	20	46	285	5	*2
41	55.7	30	21	55	411	2	*2

*1 C-Ring=C41, Pin/O-Ring=A41/B41 → P268-269
*2 C-Ring=C42, Pin/O-Ring=A42/B42

RS14405M/11

Socket Set on Rail
Steckschlüsselsatz auf Schiene
Jeu de douilles sur rail



RS14405M/11	11 Pieces Set/Rail 300mm	(g)
9,10,11,12,13,14,15,16,17,18,19		1,250

1/2"

Impact Sockets
Impact Steckschlüssel
Douilles Impact

14401M (mm)	D ₁ (mm)	D ₂ (mm)	H (mm)	L (mm)	(g)	(pcs.)	
8	13	24	6	38	57	10	*1
9	14.2	24	7	38	58	10	*1
10	15.5	24	7	38	60	10	*1
11	16.7	24	8	38	62	10	*1
12	18	24	9	38	63	10	*1
13	19.2	24	10	38	65	10	*1
14	20.5	24	10	38	67	10	*1
15	21.7	29	11	38	100	10	*2
16	23	29	11	38	102	10	*2
17	24.2	29	12	38	105	10	*2
18	25.5	29	13	38	105	10	*2
19	26.7	29	13	38	107	10	*2
20	28	29	13	38	108	10	*2
21	29.2	29	14	38	109	10	*2
22	30.5	29	14	38	114	10	*2
23	31.7	29	14	38	118	10	*2
24	33	29	14	38	122	10	*2
25	34.2	29	14	38	129	10	*2
26	35.5	29	14	38	131	10	*2
27	36.7	29	16	40	145	10	*2
28	38	29	16	40	152	10	*2
29	39.2	29	17	42	165	10	*2
30	40.5	29	17	42	178	10	*2
31	41.7	29	17	42	185	10	*2
32	43	29	18	42	188	10	*2
33	44.2	29	19	46	219	5	*2
34	45.5	29	19	46	248	5	*2
35	46.7	29	19	46	250	5	*2
36	48	29	20	46	264	5	*2
38	50.5	29	20	53	316	5	*2
41	54.2	29	21	55	374	2	*2

*1 C-Ring=C41, Pin/O-Ring=A41/B41 → P268-269
*2 C-Ring=C42, Pin/O-Ring=A42/B42

RS14401M/10	10 Pieces Set/Rail 300mm	(g)
10, 12, 13, 14, 17, 19, 21, 22, 24, 27		1,010

14401M / 14401A

6-point Sockets, Thin Walled
6-kant Steckschlüssel, dünnwandig
Douilles à paroi mince, 6-pans

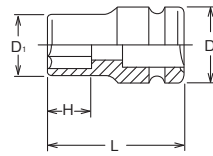

14401A (inch)	D ₁ (mm)	D ₂ (mm)	H (mm)	L (mm)	(g)	(pcs.)	
1/4	10.5	24	5	38	55	10	*1
5/16	13	24	6	38	57	10	*1
3/8	15.5	24	7	38	60	10	*1
7/16	16.7	24	8	38	62	10	*1
1/2	19.2	24	10	38	65	10	*1
9/16	20.5	24	10	38	67	10	*1
5/8	23	29	11	38	102	10	*2
11/16	24.2	29	12	38	105	10	*2
3/4	26.7	29	13	38	107	10	*2
13/16	29.2	29	14	38	109	10	*2
7/8	30.5	29	14	38	114	10	*2
15/16	33	29	14	38	122	10	*2
1	34.2	29	14	38	129	10	*2
1. 1/16	35.5	29	14	40	131	10	*2
1. 1/8	39.2	29	17	42	165	10	*2
1. 3/16	40.5	29	17	42	178	10	*2
1. 1/4	43	29	18	42	188	10	*2
1. 5/16	44.2	29	19	46	219	5	*2
1. 3/8	45.5	29	19	46	248	5	*2

*1 C-Ring=C41, Pin/O-Ring=A41/B41 → P268-269
*2 C-Ring=C42, Pin/O-Ring=A42/B42

RS14401M/10



Socket Set on Rail
Steckschlüsselsatz auf Schiene
Jeu de douilles sur rail



14406M / 14406A

12-point Sockets, Thin Walled
12-kant Steckschlüssel, dünnwandig
Douilles à paroi mince, 12-pans

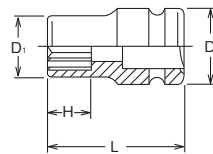

14406M (mm)	D ₁ (mm)	D ₂ (mm)	H (mm)	L (mm)	(g)	(pcs.)	
8	13	24	6	38	57	10	*1
9	14.2	24	7	38	58	10	*1
10	15.5	24	7	38	60	10	*1
11	16.7	24	8	38	62	10	*1
12	18	24	9	38	63	10	*1
13	19.2	24	10	38	65	10	*1
14	20.5	24	10	38	67	10	*1
15	21.7	29	11	38	100	10	*2
16	23	29	11	38	102	10	*2
17	24.2	29	12	38	105	10	*2
18	25.5	29	13	38	105	10	*2
19	26.7	29	13	38	107	10	*2
20	28	29	13	38	108	10	*2
21	29.2	29	14	38	109	10	*2
22	30.5	29	14	38	114	10	*2
23	31.7	29	14	38	118	10	*2
24	33	29	14	38	122	10	*2
25	34.2	29	14	38	129	10	*2
26	35.5	29	14	38	131	10	*2
27	36.7	29	16	40	145	10	*2
28	38	29	16	40	152	10	*2
29	39.2	29	17	42	165	10	*2
30	40.5	29	17	42	178	10	*2
31	41.7	29	17	42	185	10	*2
32	43	29	18	42	188	10	*2
33	44.2	29	19	46	219	5	*2
34	45.5	29	19	46	248	5	*2
36	48	29	20	46	264	5	*2

*1 C-Ring=C41, Pin/O-Ring=A41/B41 → P268-269
*2 C-Ring=C42, Pin/O-Ring=A42/B42

14406A (inch)	D ₁ (mm)	D ₂ (mm)	H (mm)	L (mm)	(g)	(pcs.)	
1/4	10.5	24	5	38	55	10	*1
5/16	13	24	6	38	57	10	*1
3/8	15.5	24	7	38	60	10	*1
7/16	16.7	24	8	38	62	10	*1
1/2	19.2	24	10	38	65	10	*1
9/16	20.5	24	10	38	67	10	*1
5/8	23	29	11	38	102	10	*2
11/16	24.2	29	12	38	105	10	*2
3/4	26.7	29	13	38	107	10	*2
13/16	29.2	29	14	38	109	10	*2
7/8	30.5	29	14	38	114	10	*2
15/16	33	29	14	38	122	10	*2
1	34.2	29	14	38	129	10	*2
1. 1/16	35.5	29	14	40	131	10	*2
1. 1/8	39.2	29	17	42	165	10	*2
1. 3/16	40.5	29	17	42	178	10	*2
1. 1/4	43	29	18	42	188	10	*2
1. 5/16	44.2	29	19	46	219	5	*2
1. 3/8	45.5	29	19	46	248	5	*2

*1 C-Ring=C41, Pin/O-Ring=A41/B41 → P268-269
*2 C-Ring=C42, Pin/O-Ring=A42/B42

Z-SERIES
HAND
TITANIUM
ACCESSORIES
SCREWDRIVERS
IMPACT
SLEEVE-DRIVE
PROTECTOR
INDUSTRIAL
AUTOMOTIVE
MOTORCYCLE
CONSTRUCTION
SPARE PART

Impact Sockets Impact Steckschlüssel 1/2"

14401MS



6-point short sockets, Thin Walled
6-kant Steckschlüssel kurz, dünnwandig
Douilles 6-pans courtes, à paroi mince

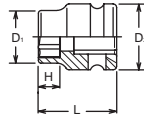

RS14401MS/10



Socket Set on Rail
Steckschlüsselsatz auf Schiene
Jeu de douilles sur rail



14401MS (mm)	D ₁ (mm)	D ₂ (mm)	H (mm)	L (mm)	(g)	(pcs.)	
10	15.5	24	4.5	23	41	10	*1
12	18	24	5.5	24	42	10	*1
13	19.2	24	6.5	25	43	10	*1
14	20.5	24	6.5	25	43	10	*1
15	21.7	29	7.5	26	70	10	*2
16	23	29	7.5	26	73	10	*2
17	24.2	29	7.5	26	76	10	*2
18	25.5	29	7.5	26	78	10	*2
19	26.7	29	9.5	28	79	10	*2
21	29.2	29	10	28.5	79	10	*2
22	30.5	29	10	28.5	84	10	*2
24	33	29	10	28.5	87	10	*2
27	36.7	29	10	28.5	100	10	*2

*1 C-Ring=C41, Pin/O-Ring=A41/B41

*2 C-Ring=C42, Pin/O-Ring=A42/B42



RS14401MS/10	10 Pieces Set/Rail 300mm	(g)
10, 12, 13, 14, 17, 19, 21, 22, 24, 27		740

14400MG



6-point Sockets with Magnet
6-kant Steckschlüssel mit Magnet
Douilles 6-pans avec aimant

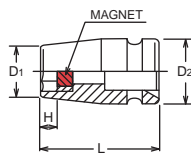

14401LH



LHS Sockets
Steckschlüssel mit LHS Profil
Douilles au profil LHS

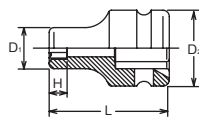

14410M



Surface Drive Sockets
Surface Drive Steckschlüssel
Douilles, Surface Drive

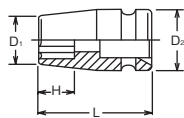

14400MG (mm)	D ₁ (mm)	D ₂ (mm)	H (mm)	L (mm)	(g)	(pcs.)	
8	14.5	25	3.5	38	95	10	*1
10	17	25	4.2	38	95	10	*1
12	19.5	25	5.6	38	100	10	*1
13	20.7	25	6	38	100	10	*1
14	22	25	6.4	38	105	10	*1
15	23.2	30	6.8	38	140	10	*2
16	24.5	30	7	38	145	10	*2
17	25.7	30	7.5	38	145	10	*2
18	27	30	7.8	38	147	10	*2
19	28.2	30	8	38	147	10	*2
21	30.7	30	8	38	165	10	*2

*1 C-Ring=C41, Pin/O-Ring=A41/B41

*2 C-Ring=C42, Pin/O-Ring=A42/B42



14401LH (LH-S)	D ₁ (mm)	D ₂ (mm)	H (mm)	L (mm)	(g)	(pcs.)	
6S	13	25	5.6	38	65	10	*1
8S	16.7	25	6.8	38	69	10	*1
10S	19.2	25	8	38	75	10	*1
12S	23	30	9.2	38	115	10	*2
14S	25.5	30	10.4	38	121	10	*2
16S	29.2	30	11.6	38	128	10	*2

*1 C-Ring=C41, Pin/O-Ring=A41/B41

*2 C-Ring=C42, Pin/O-Ring=A42/B42



14410M (mm)	D ₁ (mm)	D ₂ (mm)	H (mm)	L (mm)	(g)	(pcs.)	
10	17	25	7	38	100	10	*1
11	18.2	25	8	38	103	10	*1
12	19.5	25	9	38	110	10	*1
13	20.7	25	10	38	113	10	*1
14	22	25	10	38	115	10	*1
15	23.2	30	11	38	120	10	*2
16	24.5	30	11	38	120	10	*2
17	25.7	30	12	38	126	10	*2
18	27	30	13	38	121	10	*2
19	28.2	30	13	38	124	10	*2
20	29.5	30	13	38	123	10	*2
21	30.7	30	14	38	120	10	*2
22	32	30	14	38	130	10	*2
23	33.2	30	14	38	130	10	*2
24	34.5	30	14	38	134	10	*2
25	35.7	30	14	38	135	10	*2
26	37	30	14	38	160	10	*2
27	38.2	30	16	40	160	10	*2
28	39.5	30	16	40	170	10	*2
29	40.7	30	17	42	190	10	*2
30	42	30	17	42	190	10	*2
31	43.2	30	17	42	213	10	*2
32	44.5	30	18	42	216	10	*2
34	47	30	19	46	263	5	*2
36	49.5	30	20	46	285	5	*2

*1 C-Ring=C41, Pin/O-Ring=A41/B41

*2 C-Ring=C42, Pin/O-Ring=A42/B42



SURFACE DRIVE

Surface drive sockets are designed to retain contact with the flat sides of the nut in order to transmit high torque and reduce nut wear. These sockets are ideal for using on polished nuts, aluminum nuts and nuts with worn out points.

Das Profil unserer Surface-Drive Steckschlüssel greift die Schraube an deren Flächen. Dies sichert eine höhere Kraftübertragung und verhindert ein Durchrutschen des Steckschlüssels. Diese Steckschlüssel eignen sich besonders für polierte Schrauben, Aluminium Schrauben und Schrauben bei denen die Ecken bereits abgerundet sind.

Notre profil Surface Drive assure le contact entre la douille et les plats de l'écrou. Ceci réduit l'usure et permet la transmission d'un couple plus élevé. C'est une solution idéale pour les écrous polies, celles en aluminium ou arrondies.

14465M (mm)	D ₁ (mm)	D ₂ (mm)	H (mm)	L (mm)	(g)	(pcs.)	
10	17	25	8	38	89	10	*1
11	18.2	25	8	38	87	10	*1
12	19.5	25	9	38	87	10	*1
13	20.7	25	9	38	86	10	*1
14	22	25	11	38	86	10	*1
15	23.2	30	11	38	131	10	*2
16	24.5	30	11	38	131	10	*2
17	25.7	30	12	38	132	10	*2
18	27	30	13	38	128	10	*2
19	28.2	30	13	38	128	10	*2
20	29.5	30	14	38	125	10	*2
21	30.7	30	14	38	128	10	*2
22	32	30	15	38	130	10	*2
23	33.2	30	15	38	135	10	*2
24	34.5	30	15	38	135	10	*2
26	37	30	15	38	152	10	*2
27	38.2	30	16	40	169	10	*2

*1 C-Ring=C41, Pin/O-Ring=A41/B41
*2 C-Ring=C42, Pin/O-Ring=A42/B42 → P268-269

14415M (mm)	D ₁ (mm)	D ₂ (mm)	H (mm)	L (mm)	(g)	(pcs.)	
14	25.7	30	10	38	138	10	*2
15	27	30	11	38	145	10	*2
16	29.5	30	11	38	150	10	*2
17	30.7	30	12	38	155	10	*2
18	32	30	13	38	165	10	*2
19	33.2	30	14	38	170	10	*2
22	38.2	30	14	40	185	10	*2
24	42	30	14	42	215	10	*2
27	45.7	30	16	46	278	5	*2
28	47	30	16	46	285	5	*2
29	49.5	30	17	46	326	5	*2

*2 C-Ring=C42, Pin/O-Ring=A42/B42 → P268-269

14425 (E)	D ₁ (mm)	D ₂ (mm)	H (mm)	L (mm)	(g)	(pcs.)	
E10	14.2	25	8.2	38	86	10	*1
E11	14.7	25	8.7	38	86	10	*1
E12	15.2	25	9.3	38	85	10	*1
E14	18.2	25	10.6	38	88	10	*1
E16	19.2	25	11.8	38	88	10	*1
E18	22.2	25	13	40	89	10	*1
E20	24.2	30	14.4	40	134	10	*2
E22	26.2	30	15.5	40	140	10	*2
E24	28.2	30	17	42	138	10	*2

*1 C-Ring=C41, Pin/O-Ring=A41/B41
*2 C-Ring=C42, Pin/O-Ring=A42/B42 → P268-269

14425 (EPL)	D ₁ (mm)	D ₂ (mm)	H (mm)	L (mm)	(g)	(pcs.)	
10EPL	14.2	25	6.2	38	86	10	*1
12EPL	15.2	25	7.2	38	86	10	*1
14EPL	18.2	25	8.1	38	88	10	*1
16EPL	19.2	25	9.1	38	88	10	*1
18EPL	22.2	25	10.2	38	90	10	*1
20EPL	24.2	30	11.2	38	135	10	*2

*1 C-Ring=C41, Pin/O-Ring=A41/B41
*2 C-Ring=C42, Pin/O-Ring=A42/B42 → P268-269

14400-WN	D ₁ (mm)	D ₂ (mm)	H (mm)	L (mm)	(g)	(pcs.)	
8WN	18.3	25	8	38	93	10	*1
9WN	19.5	25	9	38	93	10	*1
10WN	20.8	25	10	38	92	10	*1
12WN	24.5	30	12	38	139	10	*2
14WN	27	30	14	38	136	10	*2
17WN	32	30	17	40	150	10	*2

*1 C-Ring=C41, Pin/O-Ring=A41/B41
*2 C-Ring=C42, Pin/O-Ring=A42/B42 → P268-269



14465M Pathfinder Sockets Pathfinder Steckschlüssel Douilles Pathfinder

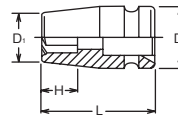

PATHFINDER®

The beveled flats of the 6-points opening of the PATHFINDER socket engage the nut almost immediately. PATHFINDER sockets are ideal for using with power tools in automatic assembly processes, as the power tool does not have to be totally stopped for the socket to engage the nut.

Da die Maschine nicht nach jedem Schraubvorgang angehalten werden muss, ergibt sich eine erhöhte Produktivität, die sich bei vollautomatischen Maschinen (Mehrschraubmaschinen) ganz besonders auswirkt.

Les parois en biais des douilles en 6-pans Pathfinder assurent l'engagement quasi immédiat de l'écrou. Le fait de ne pas devoir arrêter la machine après chaque serrage, engendre une productivité supérieure dans les chaînes de montage automatiques.

14415M Double 4-point Socket Doppelvierkant Steckschlüssel Douilles 4-pans, doubles

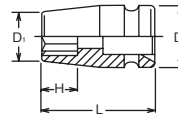

14425 TORX® Sockets TORX® Steckschlüssel Douilles TORX®

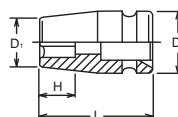

14425 (EPL) TORXPLUS® Sockets TORXPLUS® Steckschlüssel Douilles TORXPLUS®

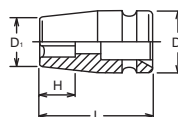

14400-WN Weld Nut Sockets Steckschlüssel für Schweissmuttern Douille pour écrou à souder

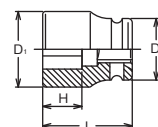

Impact Sockets

Impact Steckschlüssel

Douilles Impact

1/2"

Z-SERIES
HAND
TITANIUM
SCREWDRIVERS ACCESSORIES
IMPACT
SLEEVE-DRIVE
PROTECTOR
INDUSTRIAL
AUTOMOTIVE
CONSTRUCTION MOTORCYCLE
SPARE PART

14301X  6-point Semi-Deep Socket, Thin Walled
6-kant Steckschlüssel mittel lang, dünnwandig
Douilles à paroi mince semi-longues, 6-pans

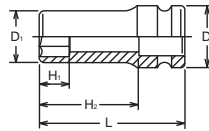

14301X (mm)	D ₁ (mm)	D ₂ (mm)	H ₁ (mm)	H ₂ (mm)	L (mm)	(g)	(pcs.)	
8	13	24	8	42	60	72	10	*1
9	14.2	24	9	42	60	75	10	*1
10	15.5	24	10	42	60	79	10	*1
11	16.7	24	11	42	60	82	10	*1
12	18	24	12	42	60	88	10	*1
13	19.2	24	13	42	60	92	10	*1
14	20.5	24	14	42	60	97	10	*1
15	21.7	29	15	42	60	125	10	*2
16	23	29	16	42	60	135	10	*2
17	24.2	29	17	42	60	142	10	*2
18	25.5	29	18	42	60	148	10	*2
19	26.7	29	19	41	60	151	10	*2
21	29.2	29	21	41	60	170	10	*2
22	30.5	29	22	45	65	187	10	*2
23	31.7	29	23	45	65	192	10	*2
24	33	29	24	45	65	202	10	*2
25	34.2	29	25	44	65	210	10	*2
26	35.5	29	26	44	65	218	10	*2
27	36.7	29	27	44	65	231	10	*2
30	40.5	29	30	44	65	268	10	*2
32	43	29	32	44	65	296	10	*2
33	44.2	29	33	44	65	318	2	*2
34	45.5	29	34	44	65	330	2	*2
36	48	29	36	44	65	350	2	*2

*1 C-Ring=C41, Pin/O-Ring=A41/B41
*2 C-Ring=C42, Pin/O-Ring=A42/B42 

RS14301X/10  Socket Set on Rail
Steckschlüsselsatz auf Schiene
Jeu de douilles sur rail



RS14301X/10	10 Pieces Set/Rail 300mm	(g)
10, 12, 13, 14, 17, 19, 21, 22, 24, 27		1,585

14300M / 14300A  6-point Deep Sockets
6-kant-Steckschlüssel,lang
Douilles longues 6-pans

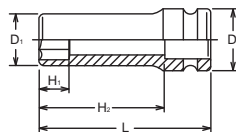

14300A (inch)	D ₁ (mm)	D ₂ (mm)	H ₁ (mm)	H ₂ (mm)	L (mm)	(g)	(pcs.)	
5/16	14.5	25	8	62	80	137	10	*1
3/8	17	25	10	62	80	140	10	*1
7/16	18.2	25	11	62	80	156	10	*1
1/2	20.7	25	13	62	80	162	10	*1
9/16	22	25	14	62	80	174	10	*1
5/8	24.5	30	16	62	80	232	10	*2
11/16	25.7	30	17	62	80	232	10	*2
3/4	28.2	30	19	61	80	259	10	*2
13/16	30.7	30	21	61	80	265	10	*2
7/8	32	30	22	65	85	290	10	*2
15/16	34.5	30	24	65	85	329	10	*2
1	35.7	30	25	65	85	345	10	*2
1. 1/16	38.2	30	27	64	85	366	10	*2
1. 1/8	40.7	30	29	63	85	401	10	*2
1. 3/16	42	30	30	63	85	421	10	*2
1. 1/4	44.5	30	32	63	85	458	10	*2
1. 7/16	50.7	30	37	61	85	580	2	*2
1. 1/2	52	30	38	61	85	600	2	*2

*1 C-Ring=C41, Pin/O-Ring=A41/B41
*2 C-Ring=C42, Pin/O-Ring=A42/B42 

14300M (mm)	D ₁ (mm)	D ₂ (mm)	H ₁ (mm)	H ₂ (mm)	L (mm)	(g)	(pcs.)	
8	14.5	25	8	62	80	137	10	*1
9	15.7	25	9	62	80	138	10	*1
10	17	25	10	62	80	140	10	*1
11	18.2	25	11	62	80	156	10	*1
12	19.5	25	12	62	80	162	10	*1
13	20.7	25	13	62	80	162	10	*1
14	22	25	14	62	80	174	10	*1
15	23.2	30	15	62	80	220	10	*2
16	24.5	30	16	62	80	232	10	*2
17	25.7	30	17	62	80	232	10	*2
18	27	30	18	62	80	232	10	*2
19	28.2	30	19	61	80	240	10	*2
20	29.5	30	20	61	80	265	10	*2
21	30.7	30	21	61	80	265	10	*2
22	32	30	22	65	85	290	10	*2
23	33.2	30	23	65	85	300	10	*2
24	34.5	30	24	65	85	329	10	*2
25	35.7	30	25	65	85	345	10	*2
26	37	30	26	64	85	350	10	*2
27	38.2	30	27	64	85	366	10	*2
28	39.5	30	28	64	85	387	10	*2
29	40.7	30	29	63	85	401	10	*2
30	42	30	30	63	85	421	10	*2
31	43.2	30	31	63	85	437	10	*2
32	44.5	30	32	63	85	458	10	*2
33	45.7	30	33	62	85	479	2	*2
34	47	30	33	62	85	496	2	*2
35	48.2	30	35	62	85	523	2	*2
36	49.5	30	36	61	85	534	2	*2
38	52	30	38	60	85	591	2	*2
41	55.7	30	38	60	85	635	2	*2

*1 C-Ring=C41, Pin/O-Ring=A41/B41
*2 C-Ring=C42, Pin/O-Ring=A42/B42 

1/2"

Impact Sockets
Impact Steckschlüssel
Douilles Impact

14301M (mm)	D ₁ (mm)	D ₂ (mm)	H ₁ (mm)	H ₂ (mm)	L (mm)	(g)	(pcs.)	
8	13	24	8	62	80	87	10	*1
9	14.2	24	9	62	80	92	10	*1
10	15.5	24	10	62	80	98	10	*1
11	16.7	24	11	62	80	104	10	*1
12	18	24	12	62	80	111	10	*1
13	19.2	24	13	62	80	120	10	*1
14	20.5	24	14	62	80	127	10	*1
15	21.7	29	15	62	80	169	10	*2
16	23	29	16	62	80	173	10	*2
17	24.2	29	17	62	80	182	10	*2
18	25.5	29	18	62	80	192	10	*2
19	26.7	29	19	61	80	197	10	*2
20	28	29	20	61	80	203	10	*2
21	29.2	29	21	61	80	218	10	*2
22	30.5	29	22	65	85	244	10	*2
23	31.7	29	23	65	85	253	10	*2
24	33	29	24	65	85	261	10	*2
25	34.2	29	25	65	85	282	10	*2
26	35.5	29	26	64	85	299	10	*2
27	36.7	29	27	64	85	314	10	*2
28	38	29	29	64	85	273	10	*2
29	39.2	29	29	63	85	280	10	*2
30	40.5	29	30	63	85	360	10	*2
31	41.7	29	31	63	85	370	10	*2
32	43	29	32	63	85	380	10	*2
34	45.5	29	34	62	85	411	2	*2
35	46.7	29	35	62	85	450	2	*2
36	48	29	36	61	85	460	2	*2
38	50.5	29	38	61	85	508	2	*2
41	54.2	29	38	60	85	552	2	*2

*1 C-Ring=C41, Pin/O-Ring=A41/B41

*2 C-Ring=C42, Pin/O-Ring=A42/B42

→ P268-269

14305M (mm)	D ₁ (mm)	D ₂ (mm)	H ₁ (mm)	H ₂ (mm)	L (mm)	(g)	(pcs.)	
8	14.5	25	8	62	80	137	10	*1
10	17	25	10	62	80	140	10	*1
11	18.2	25	11	62	80	156	10	*1
12	19.5	25	12	62	80	162	10	*1
13	20.7	25	13	62	80	162	10	*1
14	22	25	14	62	80	174	10	*1
15	23.2	30	15	62	80	220	10	*2
16	24.5	30	16	62	80	232	10	*2
17	25.7	30	17	62	80	232	10	*2
18	27	30	18	62	80	232	10	*2
19	28.2	30	19	61	80	259	10	*2
20	29.5	30	20	61	80	265	10	*2
21	30.7	30	21	61	80	265	10	*2
22	32	30	22	65	85	290	10	*2
23	33.2	30	23	65	85	300	10	*2
24	34.5	30	24	65	85	329	10	*2
26	37	30	26	64	85	350	10	*2
27	38.2	30	27	64	85	385	10	*2
28	39.5	30	28	64	85	390	10	*2
29	40.7	30	29	63	85	416	10	*2
30	42	30	30	63	85	457	10	*2
32	44.5	30	32	63	85	542	10	*2
33	45.7	30	33	62	85	562	2	*2
36	49.5	30	36	61	85	635	2	*2

*1 C-Ring=C41, Pin/O-Ring=A41/B41

*2 C-Ring=C42, Pin/O-Ring=A42/B42

→ P268-269

14306M (mm)	D ₁ (mm)	D ₂ (mm)	H ₁ (mm)	H ₂ (mm)	L (mm)	(g)	(pcs.)	
8	13	24	8	62	80	88	10	*1
10	15.5	24	10	62	80	98	10	*1
11	16.7	24	11	62	80	104	10	*1
12	18	24	12	62	80	111	10	*1
13	19.2	24	13	62	80	120	10	*1
14	20.5	24	14	62	80	127	10	*1
15	21.7	29	15	62	80	169	10	*2
16	23	29	16	62	80	173	10	*2
17	24.2	29	17	62	80	182	10	*2
18	25.5	29	18	62	80	192	10	*2
19	26.7	29	19	61	80	197	10	*2
21	29.2	29	21	61	80	218	10	*2
22	30.5	29	22	65	85	244	10	*2
24	33	29	24	65	85	261	10	*2
26	35.5	29	26	64	85	299	10	*2
27	36.7	29	27	64	85	314	10	*2
30	40.5	29	30	63	85	360	10	*2
32	43	29	32	63	85	380	10	*2

*1 C-Ring=C41, Pin/O-Ring=A41/B41

*2 C-Ring=C42, Pin/O-Ring=A42/B42

→ P268-269

14301M / 14301A

6-point Deep Sockets, Thin Walled
6-kant Steckschlüssel, dünnwandig
Douilles à paroi mince longues, 6-pans

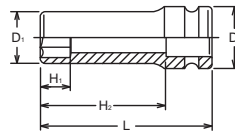

14301A (inch)	D ₁ (mm)	D ₂ (mm)	H ₁ (mm)	H ₂ (mm)	L (mm)	(g)	(pcs.)	
New 5/16	13	24	8	62	80	87	10	*1
3/8	15.5	24	10	62	80	98	10	*1
7/16	16.7	24	11	62	80	104	10	*1
1/2	19.2	24	13	62	80	120	10	*1
9/16	20.5	24	14	62	80	127	10	*1
5/8	23	29	16	62	80	173	10	*2
11/16	24.2	29	17	62	80	182	10	*2
3/4	26.7	29	19	61	80	197	10	*2
13/16	29.2	29	21	61	80	218	10	*2
7/8	30.5	29	22	65	85	244	10	*2
15/16	33	29	24	65	85	261	10	*2
New 1	34.2	29	25	65	85	282	10	*2
1. 1/16	36.7	29	27	64	85	314	10	*2
1. 1/8	39.2	29	29	63	85	349	10	*2

*1 C-Ring=C41, Pin/O-Ring=A41/B41

*2 C-Ring=C42, Pin/O-Ring=A42/B42

→ P268-269

14305M

12-point Deep Sockets
12-kant Steckschlüssel, lang
Douilles longues 12-pans

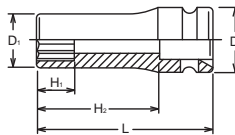

14306M

12-point Deep Sockets, Thin Walled
12-kant Steckschlüssel, dünnwandig
Douilles à paroi mince longues, 12-pans

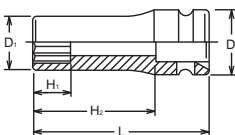

Z-SERIES
HAND
TITANIUM
ACCESSORIES
SCREWDRIVERS
IMPACT
SLEEVE-DRIVE
PROTECTOR
INDUSTRIAL
AUTOMOTIVE
MOTORCYCLE
CONSTRUCTION
SPARE PART

Impact Sockets

Impact Steckschlüssel

Douilles Impact

1/2"

Z-SERIES
HAND
TITANIUM
SCREWDRIVERS ACCESSORIES
IMPACT
SLEEVE-DRIVE
PROTECTOR
INDUSTRIAL
AUTOMOTIVE
MOTORCYCLE
CONSTRUCTION
SPARE PART

14310M

Surface Drive Sockets, deep
Surface Drive Steckschlüssel, lang
Douilles longues, Surface Drive

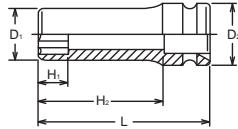

14310M (mm)	D ₁ (mm)	D ₂ (mm)	H ₁ (mm)	H ₂ (mm)	L (mm)	(g)	(pcs.)	
10	17	25	10	62	80	136	10	*1
11	18.2	25	11	62	80	148	10	*1
12	19.5	25	12	62	80	156	10	*1
13	20.7	25	13	62	80	158	10	*1
14	22	25	14	62	80	170	10	*1
15	23.2	30	15	62	80	225	10	*2
16	24.5	30	16	62	80	228	10	*2
17	25.7	30	17	62	80	232	10	*2
18	27	30	18	62	80	232	10	*2
19	28.2	30	19	61	80	252	10	*2
20	29.5	30	20	61	80	260	10	*2
21	30.7	30	21	61	80	260	10	*2
22	32	30	22	65	85	290	10	*2
23	33.2	30	23	65	85	300	10	*2
24	34.5	30	24	65	85	322	10	*2
25	35.7	30	25	65	85	338	10	*2
26	37	30	26	64	85	350	10	*2
27	38.2	30	27	64	85	380	10	*2
28	39.5	30	28	64	85	390	10	*2
29	40.7	30	29	63	85	416	10	*2
30	42	30	30	63	85	450	10	*2
31	43.2	30	31	63	85	505	10	*2
32	44.5	30	32	63	85	535	10	*2
34	47	30	34	62	85	563	2	*2
36	49.5	30	36	61	85	630	2	*2

*1 C-Ring=C41, Pin/O-Ring=A41/B41
*2 C-Ring=C42, Pin/O-Ring=A42/B42 → P268-269

14300G

Impact Socket with Sliding Magnet
Impact Steckschlüssel mit versenkbarem Magnet
Douilles Impact avec aimant, glissant pour écrous

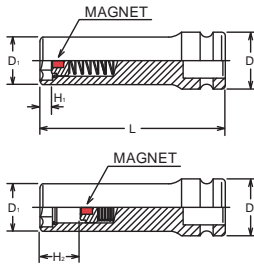

14300G (mm)	D ₁ (mm)	D ₂ (mm)	H ₁ (mm)	H ₂ (mm)	L (mm)	(g)	(pcs.)	
10	17	25	4.5	26	80	139	10	*1
12	19.5	25	6	26	80	165	10	*1
13	20.7	25	6.5	25	80	185	10	*1
14	22	25	7	24	80	189	10	*1
15	23.2	30	7	24	80	240	10	*2
16	24.5	30	7.5	26.5	80	270	10	*2
17	25.7	30	8	26.5	80	272	10	*2
18	27	30	8.5	26.5	80	290	10	*2
19	28.2	30	9	27.5	80	308	10	*2

*1 C-Ring=C41, Pin/O-Ring=A41/B41
*2 C-Ring=C42, Pin/O-Ring=A42/B42 → P268-269

14365M

Pathfinder Sockets, deep
Pathfinder Steckschlüssel, lang
Douilles longues, Pathfinder

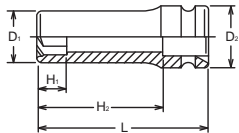

14365M (mm)	D ₁ (mm)	D ₂ (mm)	H ₁ (mm)	H ₂ (mm)	L (mm)	(g)	(pcs.)	
10	17	25	8	62	80	138	10	*1
11	18.2	25	8	62	80	144	10	*1
12	19.5	25	9	62	80	165	10	*1
13	20.7	25	9	62	80	170	10	*1
14	22	25	11	62	80	178	10	*1
15	23.2	30	11	62	80	237	10	*2
16	24.5	30	11	62	80	245	10	*2
17	25.7	30	12	62	80	263	10	*2
18	27	30	13	62	80	268	10	*2
19	28.2	30	13	61	80	270	10	*2
20	29.5	30	14	61	80	274	10	*2
21	30.7	30	14	61	80	287	10	*2
22	32	30	15	65	85	314	10	*2
23	33.2	30	15	65	85	320	10	*2
24	34.5	30	15	65	85	335	10	*2
26	37	30	15	64	85	388	10	*2
27	38.2	30	16	64	85	407	10	*2

*1 C-Ring=C41, Pin/O-Ring=A41/B41
*2 C-Ring=C42, Pin/O-Ring=A42/B42 → P268-269

14325

TORX® Deep Sockets
TORX® Steckschlüssel, lang
Douilles longues TORX®

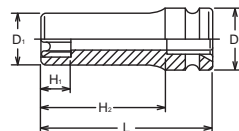

14325 (E)	D ₁ (mm)	D ₂ (mm)	H ₁ (mm)	H ₂ (mm)	L (mm)	(g)	(pcs.)	
E10	14.2	25	8.2	62	80	136	10	*1
E12	15.2	25	9.3	62	80	141	10	*1
E14	18.2	25	10.6	62	80	147	10	*1
E16	19.2	25	11.8	62	80	151	10	*1
E18	22.2	25	13	62	80	218	10	*1
E20	24.2	30	14.4	62	80	225	10	*2

*1 C-Ring=C41, Pin/O-Ring=A41/B41
*2 C-Ring=C42, Pin/O-Ring=A42/B42 → P268-269

TORX® is a registered trademark of CAMCAR Innovations.
TORX® ist ein registriertes Markenzeichen der Firma CAMCAR Innovations.
TORX® est une marque déposée de CAMCAR Innovations.

1/2"

Impact Sockets
Impact Steckschlüssel
Douilles Impact

14440M (mm)	D (mm)	H (mm)	L (mm)	(g)	(pcs.)	
13	20.7	6	67.5	210	10	*2
14	22	7	69.5	210	10	*2
15	23.2	7	69.5	210	10	*2
16	24.5	8	69.5	206	10	*2
17	25.7	8	69.5	220	10	*2
18	27	9	69.5	218	10	*2
19	28.2	10	73.5	260	10	*2
20	29.5	10	73.5	270	10	*2
21	30.7	11	73.5	280	10	*2
22	32	13	73.5	290	10	*2
24	34.5	14	75.5	300	10	*2

14440A (inch)	D (mm)	H (mm)	L (mm)	(g)	(pcs.)	
1/2	20.7	6	67.5	210	10	*2
9/16	22	7	69.5	210	10	*2
5/8	24.5	8	69.5	206	10	*2
11/16	25.7	8	69.5	220	10	*2
3/4	28.2	10	73.5	260	10	*2

*2 C-Ring=C42, Pin/O-Ring=A42/B42 → P268-269

14100M (mm)	D ₁ (mm)	D ₂ (mm)	L (mm)	(g)	(pcs.)	
6	24	25	48	126	10	*1
7	24	25	48	126	10	*1
8	24	25	48	122	10	*1
9	28	30	48	181	10	*2
10	28	30	48	181	10	*2
12	28	30	48	175	10	*2

14100A (inch)	D ₁ (mm)	D ₂ (mm)	L (mm)	(g)	(pcs.)	
1/4	24	25	48	126	10	*1
5/16	24	25	48	122	10	*1
3/8	28	30	48	181	10	*2
7/16	28	30	48	181	10	*2
1/2	28	30	48	180	10	*2

*1 C-Ring=C41, Pin/O-Ring=A41/B41
*2 C-Ring=C42, Pin/O-Ring=A42/B42 → P268-269

Tolerance

14100M (mm)	14100A (inch)
6	5.6- 6
7	6.6- 7
8	7.6- 8
9	8.4- 9
10	9.4-10
12	11.4-12

14103M (mm)	D ₁ (mm)	D ₂ (mm)	H (mm)	L (mm)	(g)	(pcs.)	
6(1.0)	12	25	10	42	75	10	*1
7(1.0)	13.2	25	11.4	42	78	10	*1
8(1.25)	14.5	25	11.5	42	81	10	*1
10(1.25)	17	25	13.5	49	106	10	*1
10(1.5)	17	25	13.5	49	106	10	*1
12(1.25)	19.5	25	15.5	49	107	10	*1
12(1.75)	19.5	25	15.5	49	107	10	*1
14(1.5)	22	25	18.2	55	128	10	*1
14(2.0)	22	25	18.2	55	128	10	*1

*1 C-Ring=C41, Pin/O-Ring=A41/B41 → P268-269
⚠ Depend on the stud bolt and using torque, 4103M/13103M/14103M may cause a scratch against the stud bolts or got stuck itself during a work.

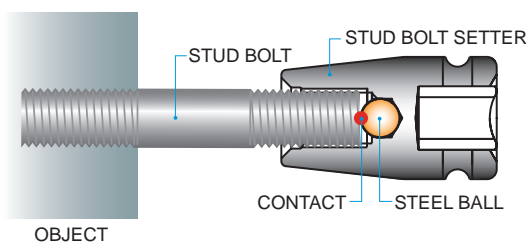

14440M / 14440A

Universal Sockets
Gelenk-Einsätze
Douilles universelles



14100M / 14100A

Impact Stud Pullers
Impact Stehbolzendreher
Extracteurs de goujons Impact



Hexagon body design can lessen the excessive load on cages and rollers inside the pullers.

Der neue Körper mit sechs Walzenmulden verteilt den Druck auf den Käfig und die Walzen weitaus vorteilhafter.

La forme hexagonale du corps améliore les tolérances.

Elle répartit l'effort de façon plus uniforme sur la cage et les rouleaux.

14103M

Impact Stud Bolt Setters
Impact Stehbolzensetzer
Monte-goujons Impact

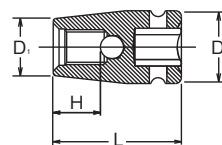

A special socket for installing a stud bolt.

Inside steel ball prevent the stud bolt stuck onto the socket. After installing a stud bolt, turn to anti-clockwise to removing the socket.

Spezialwerkzeug zum Setzen von Stehbolzen. Der Bolzen trifft im Werkzeug nur auf die gehärtete Stahlkugel, was die Kontaktfläche verringert. Nach dem Setzen des Stehbolzens kann das Werkzeug im Linkslauf vom Stehbolzen abgezogen werden.

Douilles spéciales pour monter les goujons.

Le goujon est en contact avec une bille d'acier pour l'empêcher d'adhérer à la douille. Après avoir posé le goujon, tourner dans le sens antihorlogique pour le retirer

Impact Sockets

Impact Steckschlüssel

Douilles Impact

1/2"

14145M-100 / -150 / -200 / -250

○ Extra Long Sockets
Schafstecsklüssel
Douilles, série allongée

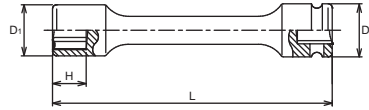

14145M-250 (mm)	D ₁ (mm)	D ₂ (mm)	H (mm)	L (mm)	(g)	(pce.)	⓪
10	17	25	10	250	278	1	*1
12	19.5	25	12	250	292	1	*1
13	20.7	25	13	250	304	1	*1
14	22	25	14	250	316	1	*1
15	23.2	25	15	250	328	1	*1
16	24.5	25	16	250	335	1	*1
17	25.7	25	17	250	341	1	*1
18	27	25	18	250	350	1	*1
19	28.2	25	19	250	355	1	*1

*1 C-Ring=41C, Pin/O-Ring=A41/B41 → P268-269

14145M-100 (mm)	D ₁ (mm)	D ₂ (mm)	H (mm)	L (mm)	(g)	(pce.)	⓪
10	17	25	10	100	155	1	*1
12	19.5	25	12	100	165	1	*1
14	22	25	14	100	180	1	*1
17	25.7	25	17	100	210	1	*1
19	28.2	25	19	100	230	1	*1

14145M-150 (mm)	D ₁ (mm)	D ₂ (mm)	H (mm)	L (mm)	(g)	(pce.)	⓪
10	17	25	10	150	190	1	*1
12	19.5	25	12	150	204	1	*1
13	20.7	25	13	150	216	1	*1
14	22	25	14	150	228	1	*1
15	23.2	25	15	150	240	1	*1
16	24.5	25	16	150	245	1	*1
17	25.7	25	17	150	253	1	*1
18	27	25	18	150	260	1	*1
19	28.2	25	19	150	267	1	*1

14145M-200 (mm)	D ₁ (mm)	D ₂ (mm)	H (mm)	L (mm)	(g)	(pce.)	⓪
10	17	25	10	200	234	1	*1
12	19.5	25	12	200	248	1	*1
13	20.7	25	13	200	260	1	*1
14	22	25	14	200	272	1	*1
15	23.2	25	15	200	284	1	*1
16	24.5	25	16	200	290	1	*1
17	25.7	25	17	200	297	1	*1
18	27	25	18	200	305	1	*1
19	28.2	25	19	200	311	1	*1

14145MG-150 / -200

ⓂG Extra Long Socket with Magnet
Schafstecsklüssel mit Magnet
Douilles, série allongée, avec aimant

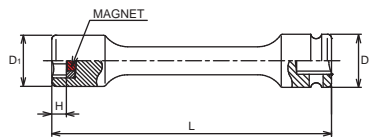

14145MG-150 (mm)	D ₁ (mm)	D ₂ (mm)	H (mm)	L (mm)	(g)	(pce.)	⓪
New 10	17	25	4.2	150	195	1	*1
New 12	19.5	25	5.6	150	210	1	*1
New 14	22	25	6.4	150	230	1	*1
New 17	25.7	25	7.5	150	266	1	*1

14145MG-200 (mm)	D ₁ (mm)	D ₂ (mm)	H (mm)	L (mm)	(g)	(pce.)	⓪
New 10	17	25	4.2	200	240	1	*1
New 12	19.5	25	5.6	200	254	1	*1
New 14	22	25	6.4	200	275	1	*1
New 17	25.7	25	7.5	200	313	1	*1

*1 C-Ring=C41, Pin/O-Ring=A41/B41 → P268-269

14146M-150 (mm)	D ₁ (mm)	D ₂ (mm)	H (mm)	L (mm)	(g)	(pce.)	
10	16	25	6.5	150	197	1	*1
12	19.3	25	7.5	150	200	1	*1
13	20	25	8	150	201	1	*1
14	21	25	8.5	150	203	1	*1
15	22	25	9	150	201	1	*1
16	23	25	9.5	150	200	1	*1
17	25	25	9.5	150	200	1	*1
18	26	25	11	150	210	1	*1
19	28	25	11.5	150	210	1	*1

14146M-200 (mm)	D ₁ (mm)	D ₂ (mm)	H (mm)	L (mm)	(g)	(pce.)	
10	16	25	6.5	200	241	1	*1
12	19.3	25	7.5	200	244	1	*1
13	20	25	8	200	245	1	*1
14	21	25	8.5	200	247	1	*1
15	22	25	9	200	245	1	*1
16	23	25	9.5	200	244	1	*1
17	25	25	9.5	200	244	1	*1
18	26	25	11	200	250	1	*1
19	28	25	11.5	200	254	1	*1

14146M-250 (mm)	D ₁ (mm)	D ₂ (mm)	H (mm)	L (mm)	(g)	(pce.)	
10	16	25	6.5	250	285	1	*1
12	19.3	25	7.5	250	288	1	*1
13	20	25	8	250	289	1	*1
14	21	25	8.5	250	291	1	*1
15	22	25	9	250	289	1	*1
16	23	25	9.5	250	288	1	*1
17	25	25	9.5	250	288	1	*1
18	26	25	11	250	290	1	*1
19	28	25	11.5	250	299	1	*1

*1 C-Ring=C41, Pin/O-Ring=A41/B41 → P268-269

14147M-150 (mm)	D ₁ (mm)	D ₂ (mm)	H (mm)	L (mm)	(g)	(pce.)	
6	25	25	15	150	200	1	*1
8	25	25	15	150	205	1	*1
10	25	25	15	150	210	1	*1
12	25	25	15	150	217	1	*1

14147M-200 (mm)	D ₁ (mm)	D ₂ (mm)	H (mm)	L (mm)	(g)	(pce.)	
6	25	25	15	200	244	1	*1
8	25	25	15	200	249	1	*1
10	25	25	15	200	254	1	*1
12	25	25	15	200	261	1	*1

*1 C-Ring=C41, Pin/O-Ring=A41/B41 → P268-269

14146M-150 / -200 / -250

Extra Long Universal Sockets
Schaftsteckschlüssel mit Gelenk
Douilles, articulées, série allongée

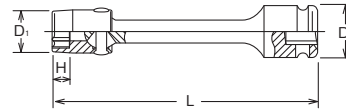

14147M-150 / -200

Extra Long Universal Inhex Sockets
Schaftsteckschlüssel mit Aussensechskant Gelenk
Douilles, articulées, à 6-pans mâle, série allongée

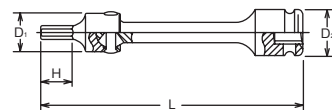

Impact Sockets

Impact Steckschlüssel

Douilles Impact

1/2"

Z-SERIES
HAND
TITANIUM
SCREWDRIVERS
ACCESSORIES
IMPACT
SLEEVE-DRIVE
PROTECTOR
INDUSTRIAL
AUTOMOTIVE
MOTORCYCLE
CONSTRUCTION
SPARE PART

14012M-60

Inhex Sockets
Steckschlüssel für Innensechskant-Schrauben
Douilles tournevis pour vis 6-pans creux

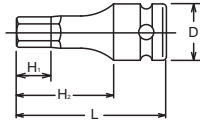

RS14012M/10-L60

Socket Set on Rail
Steckschlüsselsatz auf Schiene
Jeu de douilles sur rail



14025-60 / -100

TORX® Bit Sockets
TORX® Bit-Steckschlüssel
Douilles tournevis, TORX®

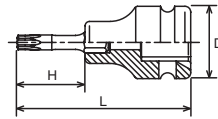

RS14025/6-L60

Socket Set on Rail
Steckschlüsselsatz auf Schiene
Jeu de douilles sur rail



14134

Impact Bit Holder
Impact Klingenhalter
Porte embouts Impact

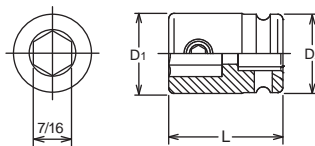

14142-F11.2

Impact Bit Holder (Quick Release)
Impact Klingenhalter (Quick Release)
Porte embouts Impact (Quick Release)

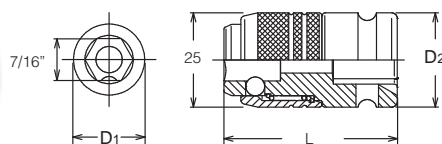

You may not hold the sliding part while moving to avoid heating up by friction and reduction by wear.
Bitte das gleitende Teil während der Bewegung nicht festhalten, um eine Erhitzung durch Reibung und durch Verschleiß zu vermeiden.
Vous ne devez pas tenir la partie coulissante pendant le déplacement afin d'éviter l'échauffement par frottement et la réduction par usure de la réduction par l'usure.

14012M-60 (mm)	D (mm)	H ₁ (mm)	H ₂ (mm)	L (mm)	(g)	(pcs.)	
4	25	15.5	38	60	68	10	*1
5	25	15.5	38	60	71	10	*1
6	25	15.5	38	60	74	10	*1
7	25	15.5	38	60	80	10	*1
8	25	15.5	38	60	84	10	*1
10	30	15.5	38	60	140	10	*2
12	30	15.5	38	60	150	10	*2
14	30	15.5	38	60	170	10	*2
16	30	15.5	38	60	180	10	*2
17	30	15.5	38	60	190	10	*2
18	30	15.5	38	60	200	10	*2
19	30	15.5	38	60	210	10	*2

*1 C-Ring=C41, Pin/O-Ring=A41/B41
*2 C-Ring=C42, Pin/O-Ring=A42/B42 → P268-269

RS14012M/10-L60	10 Pieces Set/Rail 300mm	(g)
4, 5, 6, 7, 8, 10, 12, 14, 17, 19		1,300

14025-60 (T)	D (mm)	H (mm)	L (mm)	(g)	(pcs.)	
T20	25	23.5	60	75	10	*1
T25	25	23.5	60	75	10	*1
T27	25	23.5	60	75	10	*1
T30	25	23.5	60	80	10	*1
T40	25	23.5	60	85	10	*1
T45	25	23.5	60	85	10	*1
T50	25	23.5	60	95	10	*1
T55	25	23.5	60	110	10	*1
T60	30	23.5	60	160	10	*2

14025-100 (T)	D (mm)	H (mm)	L (mm)	(g)	(pcs.)	
T30	25	73.5	100	85	10	*1
T40	25	73.5	100	95	10	*1
T45	25	73.5	100	102	10	*1
T50	25	73.5	100	120	10	*1
T55	25	73.5	100	155	10	*1
T60	30	73.5	100	220	10	*2

*1 C-Ring=C41, Pin/O-Ring=A41/B41
*2 C-Ring=C42, Pin/O-Ring=A42/B42 → P268-269

RS14025/6-L60	6 Pieces Set/Rail 200mm	(g)
T30, T40, T45, T50, T55, T60		650

	D ₁ (mm)	D ₂ (mm)	L (mm)	(g)	(pcs.)	
14134	24	25	38	90	10	*1

*1 C-Ring=C41, Pin/O-Ring=A41/B41 → P268-269

For DIN3126 E11.2 Bits
Für DIN3126 E11.2 Bits
Pour DIN3126 E11.2 Embouts

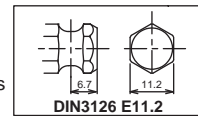

16134-SC

Replacement Screw : M8x6, ● 4mm
Ersatzschraube : M8x6, ● 4mm
Vis de remplacement : M8x6, ● 4mm

	D ₁ (mm)	D ₂ (mm)	L (mm)	(g)	(pcs.)	
14142-F11.2	18.9	25	46	207	10	*1

*1 C-Ring=C41, Pin/O-Ring=A41/B41 → P268-269

For DIN3126 E11.2 Bits
Für DIN3126 E11.2 Bits
Pour DIN3126 E11.2 Embouts

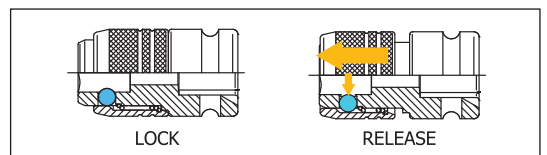
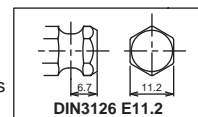

TORX is a registered trademark of CAMCAR Innovations.
TORX ist ein registriertes Markenzeichen der Firma CAMCAR Innovations.
TORX est une marque déposée de CAMCAR Innovations.

1/2"

Impact Sockets
Impact Steckschlüssel
Douilles Impact

183H-35 / -75 / -150

Hex Bits
Sechskant Bits
Embout, 6 pans creux

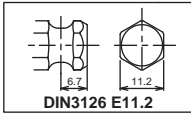
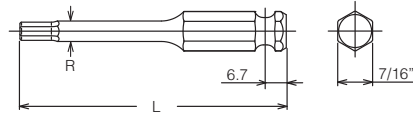

183H-35 (mm)	L (mm)	(g)	(pcs.)
3	35	15	10
4	35	15	10
5	35	15	10
6	35	18	10
7	35	19	10
8	35	20	10
9	35	23	10
10	35	26	10
11	35	28	10
12	35	30	10
14	35	35	10
16	35	47	10
17	35	50	10
18	35	53	10
19	35	56	10

183H-35 (inch)	L (mm)	(g)	(pcs.)
3/16	35	15	10
7/32	35	16	10
1/4	35	18	10
5/16	35	20	10
3/8	35	26	10
7/16	35	28	10
1/2	35	38	10

183H-75 (mm)	L (mm)	R (mm)	(g)	(pcs.)
3	75	6	34	10
4	75	6	35	10
5	75	6.5	36	10
6	75	7.5	39	10
7	75	8.5	44	10
8	75	9.5	47	10
10	75	-	57	10
11	75	-	60	10
12	75	-	65	10
14	75	-	79	10

183H-150 (mm)	L (mm)	R (mm)	(g)	(pcs.)
4	150	6	51	10
5	150	6.5	55	10
6	150	7.5	65	10
8	150	9.5	87	10
10	150	-	118	10
12	150	-	136	10

⚠ The items with ⚠ have larger output sizes than 7/16" Input drive. Due to this design the maximum output torque rating is less than standard.

Die mit ⚠ gekennzeichneten Artikel haben größere Abtriebsgrößen als der 7/16" Antrieb. Aufgrund dieser Konstruktion ist das maximale Abtriebsdrehmoment geringer als der Standardwert.

Les articles marqués d'un ⚠ ont des tailles de sortie plus importantes que l'entraînement d'entrée 7/16".

En raison de cette conception, le couple de sortie maximum est inférieur au couple standard.

183H-75B / -150B

Ball-point Hex Bits
Sechskant Bits mit Kugelkopf
Embout hexagonal à tête sphérique

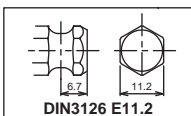
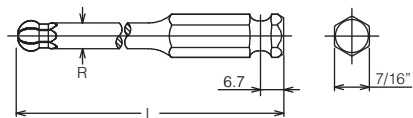

183H-75B (mm)	L (mm)	R (mm)	(g)	(pcs.)
New 6B	75	5.7	39	10
New 8B	75	7.7	44	10
New 10B	75	9.7	49	10
New 12B	75	11.7	72	10

183H-150B (mm)	L (mm)	R (mm)	(g)	(pcs.)
New 6B	150	5.7	65	10
New 8B	150	7.7	71	10
New 10B	150	9.7	92	10
New 12B	150	11.7	135	10

Impact Sockets
Impact Steckschlüssel
Douilles Impact

1/2"

Z-SERIES
HAND
TITANIUM
SCREWDRIVERS ACCESSORIES
IMPACT
SLEEVE-DRIVE
PROTECTOR
INDUSTRIAL
AUTOMOTIVE
MOTORCYCLE
CONSTRUCTION
SPARE PART

183T-35 / -75 / -150 (T)

TORX® Bits
TORX® Bits
Embout, TORX®

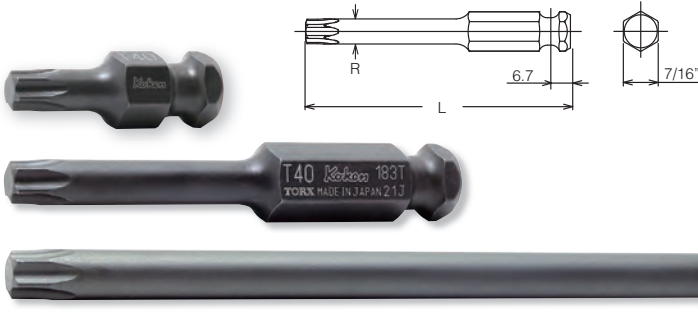

183T-35 (T)	L (mm)	(g)	(pcs.)
T25	35	18	10
T30	35	18	10
T40	35	20	10
T45	35	22	10
T50	35	26	10
T55	35	30	10
T60	35	38	10

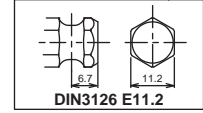

183T-75 (T)	L (mm)	R (mm)	(g)	(pcs.)
T25	75	6	33	10
T27	75	6	33	10
T30	75	6	35	10
T40	75	6.9	37	10
T45	75	8	41	10
T50	75	9	45	10
T55	75	11.4	55	10
T60	75	13.5	67	10

183T-150 (T)	L (mm)	R (mm)	(g)	(pcs.)
T30	150	6	50	10
T40	150	6.9	58	10
T45	150	8	70	10
T50	150	9	82	10
T55	150	11.4	113	10
T60	150	13.5	148	10

183T-35 / -75 (IP)

TORXPLUS® Bits
TORXPLUS® Bits
Embout TORXPLUS®

TORXplus®

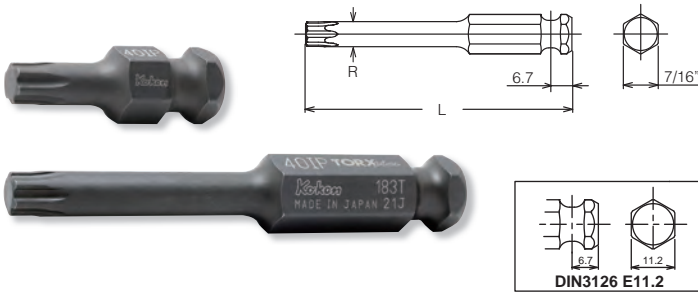

183T-35 (IP)	L (mm)	(g)	(pcs.)
30IP	35	18	10
40IP	35	20	10
45IP	35	22	10
50IP	35	26	10
55IP	35	30	10
60IP	35	38	10

183T-75 (IP)	L (mm)	R (mm)	(g)	(pcs.)
30IP	75	6	35	10
40IP	75	6.8	37	10
45IP	75	8	41	10
50IP	75	9	45	10
55IP	75	11.4	56	10
60IP	75	13.5	67	10

183X-35 / -75 / -150 (XZN)

XZN Bits
XZN Bits
Embout, XZN

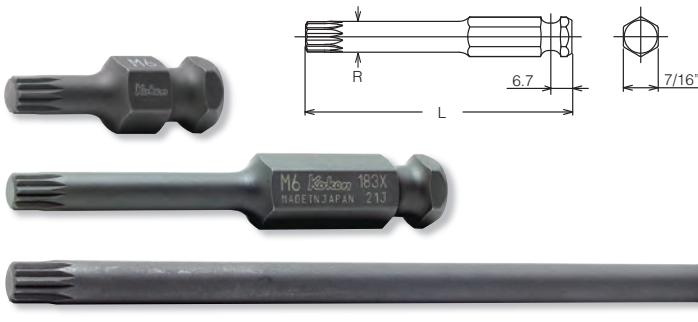

183X-35 (XZN)	L (mm)	(g)	(pcs.)
M 4	35	18	10
M 5	35	18	10
M 6	35	20	10
M 8	35	22	10
M10	35	26	10
M12	35	30	10
M14	35	38	10

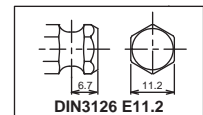

183X-75 (XZN)	L (mm)	R (mm)	(g)	(pcs.)
M 4	75	6	34	10
M 5	75	6	34	10
M 6	75	6.2	36	10
M 8	75	7.4	39	10
M10	75	9.8	54	10
M12	75	11.7	57	10
M14	75	13.5	67	10

183X-150 (XZN)	L (mm)	R (mm)	(g)	(pcs.)
M 5	150	6	50	10
M 6	150	6.2	53	10
M 8	150	7.4	64	10
M10	150	9.8	93	10
M12	150	11.7	121	10
M14	150	13.5	151	10

The items with ⚠ have larger output sizes than 7/16" Input drive.
Due to this design the maximum output torque rating is less than standard.
Die mit ⚠ gekennzeichneten Artikel haben größere Abtriebsgrößen als der 7/16" Antrieb.
Aufgrund dieser Konstruktion ist das maximale Abtriebsdrehmoment geringer als der Standardwert.
Les articles marqués d'un ⚠ ont des tailles de sortie plus importantes que l'entraînement d'entrée 7/16".
En raison de cette conception, le couple de sortie maximum est inférieur au couple standard.

14134M-58 (mm)	D (mm)	H (mm)	L (mm)	R (mm)	(g)	(pcs.)	
3	25	20	58	6	105	10	*1
4	25	20	58	6	105	10	*1
5	25	20	58	6.5	105	10	*1
6	25	20	58	7.5	108	10	*1
7	25	20	58	8.5	110	10	*1
8	25	20	58	9.5	110	10	*1
10	25	20	58	-	116	10	*1
12	25	20	58	-	120	10	*1
14	25	20	58	-	125	10	*1

14134M-98 (mm)	D (mm)	H (mm)	L (mm)	R (mm)	(g)	(pcs.)	
3	25	20	98	6	124	5	*1
4	25	20	98	6	125	5	*1
5	25	20	98	6.5	126	5	*1
6	25	20	98	7.5	129	5	*1
7	25	20	98	8.5	135	5	*1
8	25	20	98	9.5	137	5	*1
10	25	20	98	-	147	5	*1
12	25	20	98	-	155	5	*1
14	25	20	98	-	169	5	*1

*1 C-Ring=C41,Pin/O-Ring=A41/B41 → P268-269

14134T-58 (T)	D (mm)	H (mm)	L (mm)	R (mm)	(g)	(pcs.)	
T25	25	20	58	6	108	10	*1
T30	25	20	58	6	108	10	*1
T40	25	20	58	6.9	110	10	*1
T45	25	20	58	8	112	10	*1
T50	25	20	58	9	116	10	*1
T55	25	20	58	11.4	120	10	*1
T60	25	20	58	13.5	128	10	*1

14134T-98 (T)	D (mm)	H (mm)	L (mm)	R (mm)	(g)	(pcs.)	
T30	25	20	98	6	125	5	*1
T40	25	20	98	6.9	127	5	*1
T45	25	20	98	8	131	5	*1
T50	25	20	98	9	135	5	*1
T55	25	20	98	11.4	145	5	*1
T60	25	20	98	13.5	157	5	*1

*1 C-Ring=C41,Pin/O-Ring=A41/B41 → P268-269

14134T-58 (IP)	D (mm)	H (mm)	L (mm)	R (mm)	(g)	(pcs.)	
30IP	25	20	58	6	108	10	*1
40IP	25	20	58	6.8	110	10	*1
45IP	25	20	58	8	112	10	*1
50IP	25	20	58	9	116	10	*1
55IP	25	20	58	11.4	120	10	*1
60IP	25	20	58	13.5	128	10	*1

14134T-98 (IP)	D (mm)	H (mm)	L (mm)	R (mm)	(g)	(pcs.)	
30IP	25	20	98	6	125	5	*1
40IP	25	20	98	6.8	127	5	*1
45IP	25	20	98	8	131	5	*1
50IP	25	20	98	9	135	5	*1
55IP	25	20	98	11.4	146	5	*1
60IP	25	20	98	13.5	159	5	*1

*1 C-Ring=C41,Pin/O-Ring=A41/B41 → P268-269

14134X-58 (XZN)	D (mm)	H (mm)	L (mm)	R (mm)	(g)	(pcs.)	
M 5	25	20	58	6	108	10	*1
M 6	25	20	58	6.2	110	10	*1
M 8	25	20	58	7.4	112	10	*1
M10	25	20	58	9.8	116	10	*1
M12	25	20	58	11.7	120	10	*1
M14	25	20	58	13.5	128	10	*1

14134X-98 (XZN)	D (mm)	H (mm)	L (mm)	R (mm)	(g)	(pcs.)	
M 5	25	20	98	6	124	5	*1
M 6	25	20	98	6.2	126	5	*1
M 8	25	20	98	7.4	129	5	*1
M10	25	20	98	9.8	144	5	*1
M12	25	20	98	11.7	149	5	*1
M14	25	20	98	13.5	159	5	*1

*1 C-Ring=C41,Pin/O-Ring=A41/B41 → P268-269

14134M-58 / -98

Bit Holder complete with Bit, Inhex
Klingenhälter komplett mit Klinge, Innensechskant
Porte embouts avec bit 6-pans creux

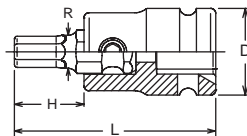

14134T-58 / -98 (T)

Bit Holder complete with TORX® Bit
Klingenhälter, komplett mit TORX® Klinge
Porte embouts avec bit TORX®

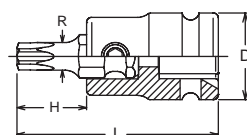

14134T-58 / -98 (IP)

Bit Holder complete with TORXPLUS® Bit
Klingenhälter, komplett mit TORXPLUS® Klinge
Porte embouts avec bit TORXPLUS®

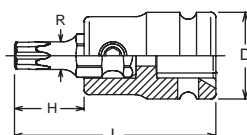

14134X-58 / -98 (XZN)

Bit Holder complete with XZN Bit
Klingenhälter, komplett mit XZN Klinge
Porte embouts avec bit XZN

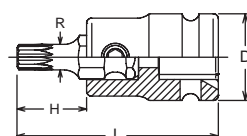

The items with have larger output sizes than 7/16" Input drive.
Due to this design the maximum output torque rating is less than standard.

Die mit gekennzeichneten Artikel haben größere Abtriebsgrößen als der 7/16" Antrieb.
Aufgrund dieser Konstruktion ist das maximale Abtriebsdrehmoment geringer als der Standardwert.

Les articles marqués d'un ont des tailles de sortie plus importantes que l'entraînement d'entrée 7/16".
En raison de cette conception, le couple de sortie maximum est inférieur au couple standard.



Impact Sockets Impact Steckschlüssel Douilles Impact

1/2"

Z-SERIES
HAND
TITANIUM
SCREWDRIVERS ACCESSORIES
IMPACT
SLEEVE-DRIVE
PROTECTOR
INDUSTRIAL
AUTOMOTIVE
MOTORCYCLE
CONSTRUCTION
SPARE PART

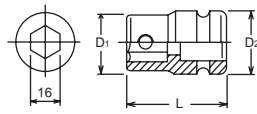
14106 Bit Holder Klingenhalter Porte-embout



	D ₁ (mm)	D ₂ (mm)	L (mm)	 (g)	 (pcs.)	
14106	28	30	43	160	10	*2



*2 C-Ring=C42, Pin/O-Ring=A42/B42 → P268-269

14106-SC

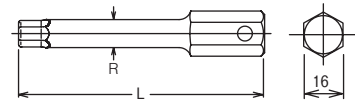
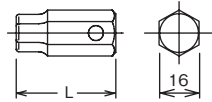

 Replacement Screw : M6x8,  3mm

107-16 Bits for Inhex Screws Klingen für Innensechskant-Schrauben Embouts pour vis 6-pans males creux





107-16 (mm)	L (mm)	 (g)	 (pcs.)
10	40	46	10
12	40	52	10
13	40	56	10
14	40	60	10
16	40	69	10
17	40	73	10
18	40	78	10
19	40	80	10
22	40	97	10



107-16 (inch)	L (mm)	 (g)	 (pcs.)
3/8	40	45	10
7/16	40	53	10
1/2	40	56	10
9/16	40	60	10
5/8	40	69	10
3/4	40	80	10







107-16(L100) (mm)	L (mm)	R (mm)	 (g)	 (pcs.)
10	100	13	118	10
12	100	15	141	10
14	100	-	163	10
17	100	-	185	10
19	100	-	228	10
22	100	-	293	10

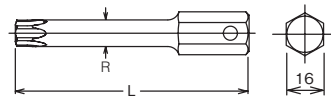
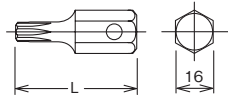

107-16 (T) TORX® Bits TORX® Klingen Embouts, TORX®



107-16 (T)	L (mm)	 (g)	 (pcs.)
T45	50	45	10
T50	50	50	10
T55	50	57	10
T60	50	64	10
T70	50	73	10

107-16(L100) (T)	L (mm)	R (mm)	 (g)	 (pcs.)
T45	100	8	95	10
T50	100	9	100	10
T55	100	11.4	104	10
T60	100	13.4	123	10
T70	100	15.7	148	10

107-16 (IP) TORXPLUS® Bits TORXPLUS® Klingen Embouts TORXPLUS®

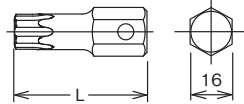



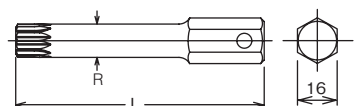
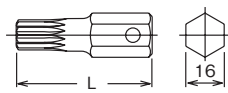

107-16 (IP)	L (mm)	 (g)	 (pcs.)
55IP	50	57	10
60IP	50	64	10
70IP	50	73	10

107-16 (XZN) Bits XZN Klingen XZN Embouts de vissage, XZN



107-16 (XZN)	L (mm)	 (g)	 (pcs.)
M14	60	83	10
M16	60	93	10
M18	60	103	10

107-16(L100) (XZN)	L (mm)	R (mm)	 (g)	 (pcs.)
M14	100	13.4	126	10
M16	100	15.8	153	10
M18	100	17.1	173	10

 The items with  have larger output sizes than 16mm Input drive.
Due to this design the maximum output torque rating is less than standard.

Die mit  gekennzeichneten Artikel haben größere Abtriebsgrößen als der 16mm Antrieb.
Aufgrund dieser Konstruktion ist das maximale Abtriebsdrehmoment geringer als der Standardwert.

Les articles marqués d'un  ont des tailles de sortie plus importantes que l'entraînement d'entrée 16mm. En raison de cette conception, le couple de sortie maximum est inférieur au couple standard.

	D ₁ (mm)	D ₂ (mm)	L (mm)	(g)	(pcs.)	
14139-1/4	11	25	35	62	10	*1

*1 C-Ring=C41,Pin/O-Ring=A41/B41 → P268-269

For DIN3126 C6.3 Bits
Für DIN3126 C6.3 Bits
Pour DIN3126 C6.3 Embouts

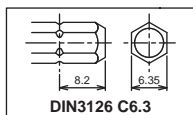

14139 ○ Bit Holder
Klingenhalter
Porte-embouts

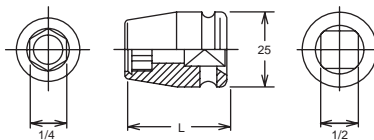

	D ₁ (mm)	D ₂ (mm)	L (mm)	(g)	(pcs.)	
14140-5/16	14	25	35	62	10	*1

*1 C-Ring=C41,Pin/O-Ring=A41/B41 → P268-269

For DIN3126 C8 Bits
Für DIN3126 C8 Bits
Pour DIN3126 C8 Embouts

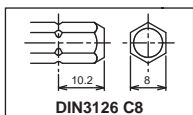

14140 ○ Bit Holder
Klingenhalter
Porte-embouts

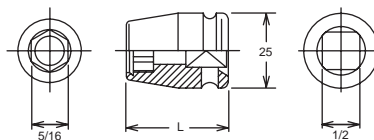

	D ₁ (mm)	D ₂ (mm)	L (mm)	(g)	(pcs.)	
14142-D6.3	16	25	55	97	10	*1

*1 C-Ring=C41,Pin/O-Ring=A41/B41 → P268-269

For DIN3126 C6.3 Bits
Für DIN3126 C6.3 Bits
Pour DIN3126 C6.3 Embouts

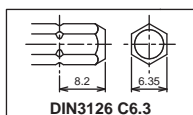

14142-D6.3 ○ Bit Holder (Quick Release)
Klingenhalter (Schnellwechselfutter)
Porte embouts (mandrin autoserrant) ⚠

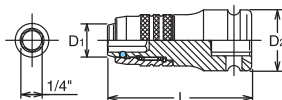

⚠ You may not hold the sliding part while moving to avoid heating up by friction and reduction by wear.
Bitte das gleitende Teil während der Bewegung nicht festhalten, um eine Erhitzung durch Reibung und durch Verschleiß zu vermeiden.
Vous ne devez pas tenir la partie coulissante pendant le déplacement afin d'éviter l'échauffement par frottement et la réduction par usure la réduction par l'usure.

	D ₁ (mm)	D ₂ (mm)	L (mm)	(g)	(pcs.)	
14142-F6.3	16.5	25	55	100	10	*1

*1 C-Ring=C41,Pin/O-Ring=A41/B41 → P268-269

For DIN3126 E6.3 Bits
Für DIN3126 E6.3 Bits
Pour DIN3126 E6.3 Embouts

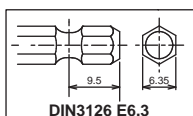

14142-F6.3 ○ Bit Holder (Quick Release)
Klingenhalter (Schnellwechselfutter)
Porte embouts (mandrin autoserrant) ⚠

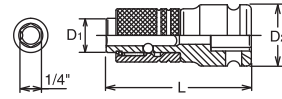

⚠ You may not hold the sliding part while moving to avoid heating up by friction and reduction by wear.
Bitte das gleitende Teil während der Bewegung nicht festhalten, um eine Erhitzung durch Reibung und durch Verschleiß zu vermeiden.
Vous ne devez pas tenir la partie coulissante pendant le déplacement afin d'éviter l'échauffement par frottement et la réduction par usure la réduction par l'usure.

Lock & Quick Release

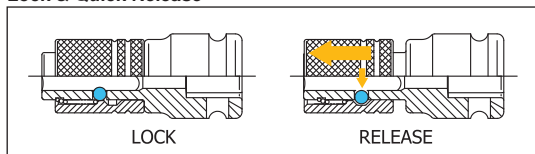

Impact Sockets Impact Steckschlüssel Douilles Impact

1/2"

Z-SERIES
HAND
TITANIUM
SCREWDRIVERS ACCESSORIES
IMPACT
SLEEVE-DRIVE
PROTECTOR
INDUSTRIAL
AUTOMOTIVE
CONSTRUCTION MOTORCYCLE
SPARE PART

14760 Extension Bars Verlängerungen Rallonges



	TYPE	D (mm)	L (mm)	(g)	(pcs.)	
14760-50	Hole	30	50	150	10	*2
14760-75	Hole	30	75	188	10	*2
14760-100	Hole	30	100	240	10	*2
14760-125	Hole	30	125	275	5	*2
14760-150	Hole	30	150	300	5	*2
14760-175	Hole	30	175	358	5	*2
14760-200	Hole	30	200	405	5	*2
14760-250	Hole	30	250	480	1	*2
14760-300	Hole	30	300	575	1	*2

*2 C-Ring=C42, Pin/O-Ring=A42/B42 → P268-269

	TYPE	D (mm)	L (mm)	(g)	(pcs.)	
14760-50P	Pin	30	50	150	10	*2
14760-75P	Pin	30	75	188	10	*2
14760-100P	Pin	30	100	240	10	*2
14760-125P	Pin	30	125	275	5	*2
14760-150P	Pin	30	150	300	5	*2
14760-175P	Pin	30	175	358	5	*2
14760-200P	Pin	30	200	405	5	*2
14760-250P	Pin	30	250	480	1	*2
14760-300P	Pin	30	300	575	1	*2

14444AL Adaptor (Quick Release) Verbindungsstück (Quick Release) Adaptateur (Quick Release)



	L (mm)	(g)	(pcs.)	
14444AL	60	128	10	*1

*1 C-Ring=C41, Pin/O-Ring=A41/B41 → P268-269

Lock & Quick Release

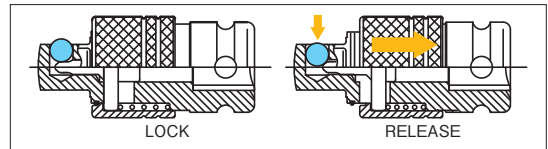

! You may not hold the sliding part while moving to avoid heating up by friction and reduction by wear.

Bitte das gleitende Teil während der Bewegung nicht festhalten, um eine Erhitzung durch Reibung und durch Verschleiß zu vermeiden.

Vous ne devez pas tenir la partie coulissante pendant le déplacement afin d'éviter l'échauffement par frottement et la réduction par usure la réduction par l'usure.

14466AL Adaptor (Quick Release) Verbindungsstück (Quick Release) Adaptateur (Quick Release)



	(sq.)	(sq.)	L (mm)	(g)	(pcs.)	
14466AL	1/2"	3/4"	75	460	5	*2

*2 C-Ring=C42, Pin/O-Ring=A42/B42 → P268-269

! You may not hold the sliding part while moving to avoid heating up by friction and reduction by wear.

Bitte das gleitende Teil während der Bewegung nicht festhalten, um eine Erhitzung durch Reibung und durch Verschleiß zu vermeiden.

Vous ne devez pas tenir la partie coulissante pendant le déplacement afin d'éviter l'échauffement par frottement et la réduction par usure la réduction par l'usure.

14444WA Angle-Adaptor with Return Spring Winkeladapter mit Rückholfeder Adaptateur angulaire avec ressort de rappel



Use a Pin/O-ring to attach a socket to 14444WA



! It is strongly recommended to check the tightening torque for applications with the adaptors 13333WA and 14444WA, as the reduced square drive reduces the overall torques.

Es wird dringend empfohlen, bei Anwendungen mit den Adaptern 13333WA und 14444WA das Anzugsmoment zu überprüfen, da der reduzierte Vierkanttrieb die Gesamtdrehmomente verringert.

Il est fortement recommandé de vérifier le couple de serrage pour les applications avec les adaptateurs 13333WA et 14444WA, car l'entraînement carré réduit diminue les couples totaux.

	D (mm)	L (mm)	(g)	(pcs.)	
14444WA	25	47	83	10	*1

*1 C-Ring=C41, Pin/O-Ring=A41/B41 → P268-269

	TYPE	L (mm)	(g)	(pcs.)	
	14770-P Pin	74	210	5	*2
New	14770-B Ball	74	210	5	*2
	14770 Hole	74	210	5	*2
	14771-P Pin	65	198	5	*2
New	14771-B Ball	65	198	5	*2
	14771 Hole	65	198	5	*2

*2 C-Ring=C42, Pin/O-Ring=A42/B42 → P268-269

Our ball joints are spring-loaded and can therefore be adjusted to an angle of max. 30°.

Unsere Kugelgelenke sind federbelastet dadurch sind sie auf einen Winkel von max 30° einstellbar.

Nos joints à rotule sont à ressort et peuvent donc être réglés jusqu'à un angle de 30° maximum.

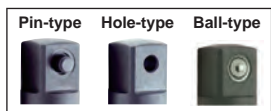
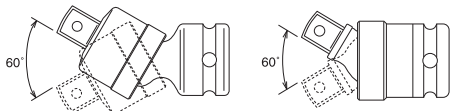

	TYPE	D ₁ (mm)	D ₂ (mm)	L (mm)	(g)	(pcs.)	
	14772-P Pin	27	25	90	230	5	*1
	14772-B Hole	27	25	90	230	5	*1

*1 C-Ring=C41, Pin/O-Ring=A41/B41 → P268-269

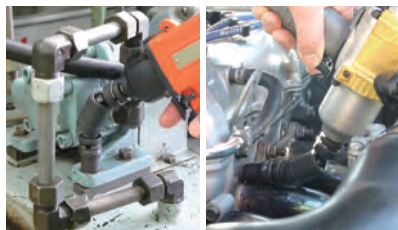

Make sure sockets hold bolts or nuts before operation.

Vergewissern Sie sich vor dem Gebrauch, dass der Steckschlüssel die Schraube sicher umfasst hat.

Avant la manipulation, il est nécessaire de s'assurer que la douille renferme parfaitement la vis.



UNIVERSAL DOUBLE JOINT

14770 Universal Joint Gelenk-Einsatz Joint articulé

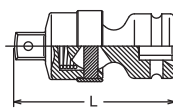

14771 Universal Joint Gelenk-Einsatz Joint articulé

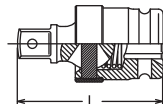

14772 Universal Double Joint Doppelgelenk-Einsatz Joint articulé double

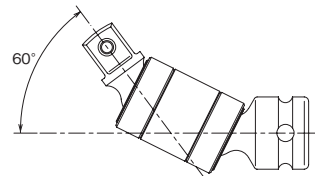
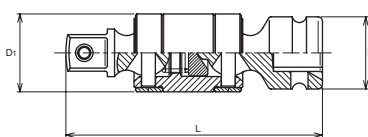

⚠ 13772 and 14772 have less load capacity than standard. In the interest of your safety always use properly.

Die Doppelgelenke 13772 und 14772 haben eine geringere Belastbarkeit als das Standardgelenk. Im Interesse Ihrer Sicherheit sollten Sie sie immer richtig verwenden.

Les doubles articulations 13772 et 14772 ont une capacité de charge inférieure à celle de l'articulation standard. Pour votre propre sécurité, vous devez toujours les utiliser correctement.

	TYPE	(sq.)	(sq.)	L (mm)	(g)	(pcs.)	
	14433A-P Pin	1/2"	3/8"	37.5	68	10	*1
New	14433A-B Ball	1/2"	3/8"	37.5	68	10	*1
	14433A Hole	1/2"	3/8"	37.5	68	10	*1

*1 C-Ring=C41, Pin/O-Ring=A41/B41 → P268-269

⚠ Adapting down from bigger square drive to smaller square drive may lead to excessive torque load and possibly cause breakage. Always stay within safe torque of the smaller square drive.

Die mit ⚠ gekennzeichneten Artikel können bei Überbelastung zu Bruch gehen. Aus Gründen Ihrer eigenen Sicherheit sollten die betreffenden Werkzeuge nie ruckartig, sondern nach und nach belastet werden, um Bruch und damit verbundene mögliche Verletzungen zu vermeiden.

Il est possible d'appliquer aux articles marqués ⚠ des couples de serrage susceptibles d'occasionner leur rupture. Pour votre propre sécurité, veuillez toujours appliquer la charge d'une manière uniforme et progressive. Ceci pour éviter ruptures et accidents.

	(sq.)	(sq.)	L (mm)	(g)	(pcs.)	
	14455A 1/2"	5/8"	42	135	10	*2

*2 C-Ring=C42, Pin/O-Ring=A42/B42 → P268-269

	TYPE	(sq.)	(sq.)	L (mm)	(g)	(pcs.)	
	14466A Hole	1/2"	3/4"	44	146	10	*2
New	14466A-B Ball	1/2"	3/4"	44	146	10	*2

*2 C-Ring=C42, Pin/O-Ring=A42/B42 → P268-269

14433A Adaptor Verbindungsstück Réducteur

No Warranty
Keine Garantie
Sans Garantie

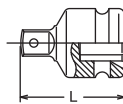

14455A Adaptor Verbindungsstück Augmentateur

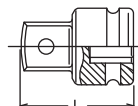

14466A Adaptor Verbindungsstück Augmentateur

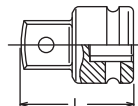





Impact Sockets Impact Steckschlüssel Douilles Impact

1/2"

Z-SERIES
HAND
TITANIUM
SCREWDRIVERS ACCESSORIES
IMPACT
SLEEVE-DRIVE
PROTECTOR
INDUSTRIAL
AUTOMOTIVE
MOTORCYCLE
CONSTRUCTION
SPARE PART

14209M  Socket Sets
Steckschlüssel Sätze
Jeu de clés à douilles







14209M 10 Pieces Set/△=830g	
METAL CASE:W190xH59xT45mm	
Bits	Bit Holder
 183H.35 Hex Bits 5, 6, 8, 10	 14134 Bit Holder
 107.16 Hex Bits 12, 14, 17, 19	 14106 Bit Holder

 × 
 ×  **DIN3126**

14210M  Socket Sets
Steckschlüssel Sätze
Jeu de clés à douilles





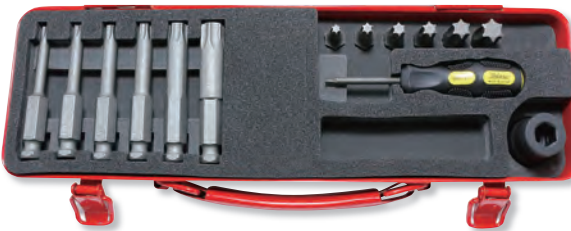

14210M 18 Pieces Set/△=1,250g	
METAL CASE:W310xH90xT48mm	
Bits	Bit Holder
 183H.35 Hex Bits 4, 5, 6, 7, 8, 10, 12, 14	 14134 Bit Holder
 183H.75 Hex Bits 4, 5, 6, 7, 8, 10, 12, 14	 168H-4 (40) Screwdriver

 ×  **DIN3126**

14210T  Socket Sets
Steckschlüssel Sätze
Jeu de clés à douilles





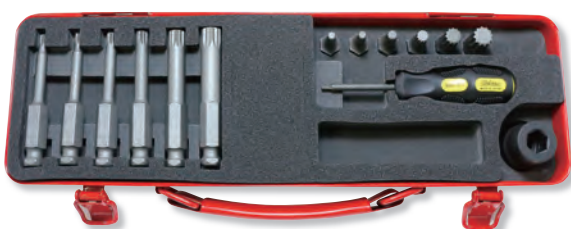

14210T 14 Pieces Set/△=1,080g	
METAL CASE:W310xH90xT48mm	
Bits	Bit Holder
 183T.35 TORX® Bits T30, T40, T45, T50, T55, T60	 14134 Bit Holder
 183T.75 TORX® Bits T30, T40, T45, T50, T55, T60	 168H-4 (40) Screwdriver

 ×  **DIN3126**

14210X  Socket Sets
Steckschlüssel Sätze
Jeu de clés à douilles



14210X 14 Pieces Set/△=1,040g	
METAL CASE:W310xH90xT48mm	
Bits	Bit Holder
 183X.35 XZN Bits M4, M5, M6, M8, M10, M12	 14134 Bit Holder
 183X.75 XZN Bits M4, M5, M6, M8, M10, M12	 168H-4 (40) Screwdriver

 ×  **DIN3126**

14207M	10 Pieces Set/△=2,700g
METAL CASE:W310xH90xT48mm	
Sockets	
 14300M 6-pt Deep Sockets 10, 12, 13, 14, 17, 19, 21, 22, 24, 27	

14207M  Socket Set
Steckschlüssel Satz
Jeu de clés à douilles



14208M	13 Pieces Set/△=3,740g
METAL CASE:W395xH90xT50mm	
Sockets	
 14300M 6-pt Deep Sockets 10, 12, 13, 14, 15, 16, 17, 18, 19, 21, 22, 24, 27	

14208M  Socket Set
Steckschlüssel Satz
Jeu de clés à douilles



14241M-00	13 Pieces Set/△=2,000g
METAL CASE:W196xH100xT45mm	
Sockets	
 14400M 6-pt. Sockets 10, 11, 12, 13, 14, 15, 16, 17, 19, 21, 22, 24, 27	

14241M-00  Socket Set
Steckschlüssel Satz
Jeu de clés à douilles

14241M-05 



14241M-05	13 Pieces Set/△=2,000g
METAL CASE:W196xH100xT45mm	
Sockets	
 14405M 12-pt. Sockets 10, 11, 12, 13, 14, 15, 16, 17, 19, 21, 22, 24, 27	

14242M  Socket Set
Steckschlüssel Satz
Jeu de clés à douilles











14242M	12 Pieces Set/△=1,890g
METAL CASE:W310xH90xT48mm	
Sockets	
 14400M 6-pt. Sockets 10, 11, 12, 13, 14, 15, 16, 17, 19, 21, 22, 27	

14245M-00  Socket Set
Steckschlüssel Satz
Jeu de clés à douilles

14245M-05 



14245M-00	18 Pieces Set/△=2,250g
METAL CASE:W310xH90xT48mm	
Sockets	Accessories
 14400M 6-pt. Sockets 10, 12, 13, 14, 16, 17, 18, 19, 21, 22, 24, 27	 14760-125P  14770-P  A41, A42 B41, B42

14245M-05	18 Pieces Set/△=2,250g
METAL CASE:W310xH90xT48mm	
Sockets	Accessories
 14405M 12-pt. Sockets 10, 12, 13, 14, 16, 17, 18, 19, 21, 22, 24, 27	 14760-125P  14770-P  A41, A42 B41, B42

Impact Sockets

Impact Steckschlüssel

Douilles Impact

5/8"

Z-SERIES
HAND
TITANIUM
SCREWDRIVERS ACCESSORIES
IMPACT
SLEEVE-DRIVE
PROTECTOR
INDUSTRIAL
AUTOMOTIVE
CONSTRUCTION MOTORCYCLE
SPARE PART

15400M

6-point Sockets
6-kant Steckschlüssel
Douilles 6-pans

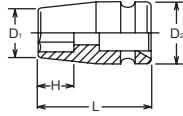

15400M (mm)	D ₁ (mm)	D ₂ (mm)	H (mm)	L (mm)	(g)	(pcs.)	
14	24	35	10	47.5	220	5	*1
17	27.8	35	12	47.5	225	5	*1
19	30.3	35	13	47.5	225	5	*1
21	32.8	35	15	47.5	225	5	*1
22	34	35	15	47.5	225	5	*1
23	35.4	35	16	47.5	225	5	*1
24	36.5	35	16	50.5	245	5	*1
26	39	35	16	50.5	260	5	*1

*1 Pin/O-Ring=A51/B51 → P269

15400A

6-point Sockets
6-kant Steckschlüssel
Douilles 6-pans

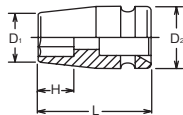

15400A (inch)	D ₁ (mm)	D ₂ (mm)	H (mm)	L (mm)	(g)	(pcs.)	
New 9/16	24	35	10	47.5	220	5	*1
New 5/8	26.5	35	11	47.5	225	5	*1
New 11/16	27.8	35	12	47.5	225	5	*1
New 3/4	30.3	35	13	47.5	225	5	*1
New 13/16	32.8	35	15	47.5	225	5	*1
New 7/8	34	35	15	47.5	225	5	*1
New 15/16	36.5	35	16	50.5	245	5	*1

*1 Pin/O-Ring=A51/B51 → P269

15410M

Surface Drive Sockets
Surface Drive Steckschlüssel
Douilles, Surface Drive

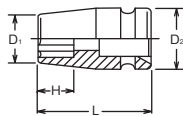

15410M (mm)	D ₁ (mm)	D ₂ (mm)	H (mm)	L (mm)	(g)	(pcs.)	
14	24	35	10	47.5	220	5	*1
17	27.8	35	12	47.5	225	5	*1
19	30.3	35	13	47.5	225	5	*1
21	32.8	35	15	47.5	225	5	*1
22	34	35	15	47.5	225	5	*1
23	35.4	35	16	47.5	225	5	*1
24	36.5	35	16	50.5	245	5	*1
26	39	35	16	50.5	260	5	*1

*1 Pin/O-Ring=A51/B51 → P269

15300M (mm)	D ₁ (mm)	D ₂ (mm)	H ₁ (mm)	H ₂ (mm)	L (mm)	(g)	(pcs.)	⚡
14	24	35	14	71	90	295	2	*1
17	27.8	35	17	71	90	325	2	*1
19	30.3	35	19	71	90	350	2	*1
21	32.8	35	21	71	90	380	2	*1
22	34	35	22	71	90	390	2	*1

*1 Pin/O-Ring=A51/B51 → P269

15300M

6-point Deep Sockets
6-kant-Steckschlüssel, lang
Douilles longues 6-pans

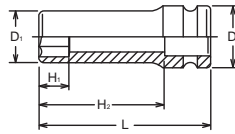

15310M (mm)	D ₁ (mm)	D ₂ (mm)	H ₁ (mm)	H ₂ (mm)	L (mm)	(g)	(pcs.)	⚡
14	24	35	14	71	90	295	2	*1
17	27.8	35	17	71	90	325	2	*1
19	30.3	35	19	71	90	350	2	*1
21	32.8	35	21	71	90	380	2	*1
22	34	35	22	71	90	390	2	*1

*1 Pin/O-Ring=A51/B51 → P269

15310M

Surface Drive Sockets, deep
Surface Drive Steckschlüssel, lang
Douilles longues, Surface Drive

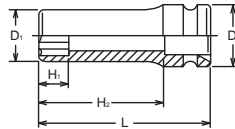

15555AL	L (mm)	(g)	(pcs.)	⚡
15555AL	70	310	2	*1

*1 Pin/O-Ring=A51/B51 → P269

15555AL

Adaptor (Quick Release)
Schnellwechsel-Verbindungsstück (Quick Release) ⚠
Adaptateur (Quick Release)

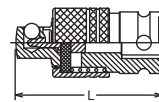
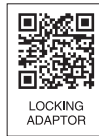

Lock & Quick Release

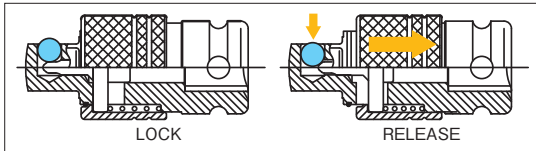

You may not hold the sliding part while moving to avoid heating up by friction and reduction by wear.
Bitte das gleitende Teil während der Bewegung nicht festhalten, um eine Erhitzung durch Reibung und durch Verschleiß zu vermeiden.

Vous ne devez pas tenir la partie coulissante pendant le déplacement afin d'éviter l'échauffement par frottement et la réduction par usure la réduction par l'usure.

15770	L (mm)	(g)	(pce.)	⚡
15770	88	420	1	*1

*1 Pin/O-Ring=A51/B51 → P269

15770

Universal Joint
Gelenk-Einsatz
Joint articulé

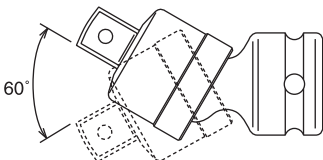
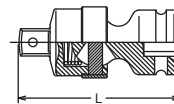

15544A

Adaptor
Verbindungsstück
Réducteur
No Warranty
Keine Garantie
Sans Garantie ⚠

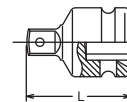
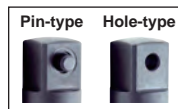

15544A-P	5/8"	1/2"	L (mm)	(g)	(pce.)	⚡
15544A-P	5/8"	1/2"	46	165	1	*1
15544A	5/8"	1/2"	46	165	1	*1

*1 Pin/O-Ring=A51/B51 → P269

⚠ Adapting down from bigger square drive to smaller square drive may lead to excessive torque load and possibly cause breakage. Always stay within safe torque of the smaller square drive.

Die mit ⚠ gekennzeichneten Artikel können bei Überbelastung zu Bruch gehen. Aus Gründen Ihrer eigenen Sicherheit sollten die betreffenden Werkzeuge nie ruckartig, sondern nach und nach belastet werden, um Bruch und damit verbundene mögliche Verletzungen zu vermeiden.

Il est possible d'appliquer aux articles marqués ⚠ des couples de serrage susceptibles d'occasionner leur rupture. Pour votre propre sécurité, veuillez toujours appliquer la charge d'une manière uniforme et progressive. Ceci pour éviter ruptures et accidents.

15566A

Adaptor
Verbindungsstück
Augmentateur

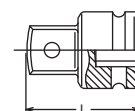

15566A	5/8"	3/4"	L (mm)	(g)	(pce.)	⚡
15566A	5/8"	3/4"	48	200	1	*1

*1 Pin/O-Ring=A51/B51 → P269

Z-SERIES
HAND
TITANIUM
SCREWDRIVERS ACCESSORIES
IMPACT
SLEEVE-DRIVE
PROTECTOR
INDUSTRIAL
AUTOMOTIVE
CONSTRUCTION MOTORCYCLE
SPARE PART

16400M / 16400A

6-point Sockets
6-kant Steckschlüssel
Douilles 6-pans

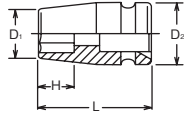

16400A (inch)	D ₁ (mm)	D ₂ (mm)	H (mm)	L (mm)	(g)	(pcs.)	
5/8	28.8	44	11	50	366	5	*1
11/16	30	44	12	50	355	5	*1
3/4	32.5	44	13	50	360	5	*1
13/16	35	44	15	50	374	5	*1
7/8	36.3	44	15	50	373	5	*1
15/16	38.8	44	16	50	370	5	*1
1	40	44	16	50	374	5	*1
1. 1/16	42.5	44	16	50	375	5	*1
1. 1/8	45	44	18	53	412	5	*1
1. 3/16	46.3	44	18	53	410	5	*1
1. 1/4	48.8	44	19	53	428	5	*1
1. 5/16	51.3	44	20	55	490	5	*1
1. 3/8	52.5	44	20	55	494	5	*1
1. 7/16	55	44	20	55	526	2	*1
1. 1/2	56.3	44	20	57	558	2	*1
1. 9/16	58.8	44	20	57	598	2	*1
1. 5/8	60	44	22	57	572	2	*1
1.11/16	62.5	44	23	62	720	2	*1
1. 3/4	65	44	23	62	757	2	*1
1.13/16	66.3	44	23	62	755	2	*1
1. 7/8	68.8	54	23	62	940	2	*2
1.15/16	70	54	23	62	912	2	*2
2	72.5	54	30	62	969	2	*2
2. 1/16	73.8	54	29	62	1011	2	*2
2. 1/8	76.3	54	29	62	1035	2	*2
2. 3/16	77.5	54	29	62	1056	2	*2
2. 1/4	80	54	32	65	1126	2	*2
2. 5/16	81.3	54	31	65	1163	2	*2
2. 3/8	83.8	54	31	65	1215	2	*2

16400M (mm)	D ₁ (mm)	D ₂ (mm)	H (mm)	L (mm)	(g)	(pcs.)	
16	28.8	44	11	50	367	5	*1
17	30	44	12	50	355	5	*1
18	31.3	44	13	50	372	5	*1
19	32.5	44	13	50	360	5	*1
20	33.8	44	14	50	375	5	*1
21	35	44	15	50	374	5	*1
22	36.3	44	15	50	373	5	*1
23	37.5	44	16	50	373	5	*1
24	38.8	44	16	50	370	5	*1
25	40	44	16	50	374	5	*1
26	41.3	44	16	50	378	5	*1
27	42.5	44	16	50	375	5	*1
28	43.8	44	16	50	383	5	*1
29	45	44	18	53	412	5	*1
30	46.3	44	18	53	410	5	*1
31	47.5	44	18	53	426	5	*1
32	48.8	44	19	53	428	5	*1
33	50	44	20	55	470	5	*1
34	51.3	44	20	55	490	5	*1
35	52.5	44	20	55	494	5	*1
36	53.8	44	20	55	498	5	*1
37	55	44	20	55	526	2	*1
38	56.3	44	20	57	558	2	*1
39	57.5	44	20	57	579	2	*1
40	58.8	44	20	57	598	2	*1
41	60	44	22	57	572	2	*1
42	61.3	44	22	57	617	2	*1
43	62.5	44	23	62	720	2	*1
44	63.8	44	23	62	761	2	*1
45	65	44	23	62	757	2	*1
46	66.3	44	23	62	755	2	*1
47	67.5	54	23	62	805	2	*2
48	68.8	54	23	62	940	2	*2
49	70	54	23	62	912	2	*2
50	71.3	54	30	62	930	2	*2
52	73.8	54	29	62	1011	2	*2
54	76.3	54	29	62	1035	2	*2
55	77.5	54	29	62	1056	2	*2
56	78.8	54	29	62	1091	2	*2
57	80	54	32	65	1126	2	*2
58	81.3	54	31	65	1163	2	*2
59	82.5	54	31	65	1185	2	*2
60	83.8	54	31	65	1215	2	*2
65	90	54	30	65	1325	2	*2
70	96.3	54	34	70	1570	1	*2

16405M / 16405A

12-point Sockets
12-kant Steckschlüssel
Douilles 12-pans

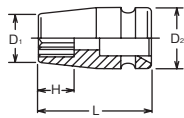

16405A (inch)	D ₁ (mm)	D ₂ (mm)	H (mm)	L (mm)	(g)	(pcs.)	
3/4	32.5	44	13	50	360	5	*1
13/16	35	44	15	50	374	5	*1
7/8	36.3	44	15	50	373	5	*1
15/16	38.8	44	16	50	370	5	*1
1	40	44	16	50	374	5	*1
1. 1/16	42.5	44	16	50	375	5	*1
1. 1/8	45	44	18	53	412	5	*1
1. 3/16	46.3	44	18	53	410	5	*1
1. 1/4	48.8	44	19	53	428	5	*1
1. 5/16	51.3	44	20	55	490	5	*1
1. 3/8	52.5	44	20	55	494	5	*1
1. 7/16	55	44	20	55	526	2	*1
1. 1/2	56.3	44	20	57	558	2	*1
1. 5/8	60	44	22	57	572	2	*1
1.11/16	62.5	44	23	62	720	2	*1
1. 3/4	65	44	23	62	757	2	*1
1. 7/8	68.8	54	23	62	940	2	*2
2	72.5	54	30	62	969	2	*2

*1 C-Ring=C61, Pin/O-Ring=A61/B61
*2 C-Ring=C81, Pin/O-Ring=A62/B62

16405M (mm)	D ₁ (mm)	D ₂ (mm)	H (mm)	L (mm)	(g)	(pcs.)	
16	28.8	44	11	50	367	5	*1
17	30	44	12	50	355	5	*1
18	31.3	44	13	50	372	5	*1
19	32.5	44	13	50	360	5	*1
20	33.8	44	14	50	375	5	*1
21	35	44	15	50	374	5	*1
22	36.3	44	15	50	373	5	*1
23	37.5	44	16	50	373	5	*1
24	38.8	44	16	50	370	5	*1
25	40	44	16	50	374	5	*1
26	41.3	44	16	50	378	5	*1
27	42.5	44	16	50	375	5	*1
28	43.8	44	16	50	383	5	*1
29	45	44	18	53	412	5	*1
30	46.3	44	18	53	410	5	*1
32	48.8	44	19	53	428	5	*1
33	50	44	20	55	470	5	*1
34	51.3	44	20	55	490	5	*1
35	52.5	44	20	55	494	5	*1
36	53.8	44	20	55	498	5	*1
38	56.3	44	20	57	558	2	*1
41	60	44	22	57	572	2	*1
42	61.3	44	22	57	617	2	*1
46	66.3	44	23	62	755	2	*1
50	71.3	54	30	62	930	2	*2
52	73.8	54	29	62	1011	2	*2
55	77.5	54	29	62	1056	2	*2
60	83.8	54	31	65	1215	2	*2
65	90	54	30	65	1325	2	*2

*1 C-Ring=C61, Pin/O-Ring=A61/B61
*2 C-Ring=C81, Pin/O-Ring=A62/B62

3/4"

Impact Sockets
Impact Steckschlüssel
Douilles Impact

16401M / 16401A

6-point Sockets, Thin Walled
6-kant Steckschlüssel, dünnwandig
Douilles à paroi mince, 6-pans



16401M (mm)	D ₁ (mm)	D ₂ (mm)	H (mm)	L (mm)	(g)	(pcs.)	
16	26.8	43	11	50	290	5	*1
17	28	43	12	50	300	5	*1
18	29.3	43	13	50	300	5	*1
19	30.5	43	13	50	300	5	*1
20	31.8	43	14	50	302	5	*1
21	33	43	15	50	305	5	*1
22	34.3	43	15	50	310	5	*1
23	35.5	43	16	50	315	5	*1
24	36.8	43	16	50	325	5	*1
25	38	43	16	50	326	5	*1
26	39.3	43	16	50	330	5	*1
27	40.5	43	16	50	340	5	*1
28	41.8	43	16	50	345	5	*1
29	43	43	18	53	355	5	*1
30	44.3	43	18	53	365	5	*1
31	45.5	43	18	53	375	5	*1
32	46.8	43	19	53	385	5	*1
33	48	43	20	55	395	5	*1
34	49.3	43	20	55	420	5	*1
35	50.5	43	20	55	430	5	*1
36	51.8	43	20	55	440	5	*1
37	53	43	20	55	460	2	*1
38	54.3	43	20	57	472	2	*1
39	55.5	43	20	57	525	2	*1
40	56.8	43	20	57	525	2	*1
41	58	43	22	57	555	2	*1
42	59.3	43	22	57	565	2	*1
43	60.5	43	23	62	662	2	*1
44	61.8	43	23	62	670	2	*1
45	63	43	23	62	700	2	*1
46	64.3	43	23	62	710	2	*1

*1 C-Ring=C61, Pin/O-Ring=A61/B61
*2 C-Ring=C81, Pin/O-Ring=A62/B62

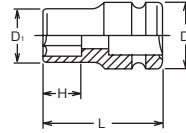

16401A (inch)	D ₁ (mm)	D ₂ (mm)	H (mm)	L (mm)	(g)	(pcs.)	
11/16	28	43	12	50	300	5	*1
3/4	30.5	43	13	50	300	5	*1
13/16	33	43	15	50	305	5	*1
7/8	34.3	43	15	50	310	5	*1
15/16	36.8	43	16	50	325	5	*1
1	38	43	16	50	326	5	*1
1. 1/16	40.5	43	16	50	340	5	*1
1. 1/8	43	43	18	53	355	5	*1
1. 3/16	44.3	43	18	53	365	5	*1
1. 1/4	46.8	43	19	53	385	5	*1
1. 5/16	49.3	43	20	55	437	5	*1
1. 3/8	50.5	43	20	55	430	5	*1
1. 7/16	53	43	20	55	460	2	*1
1. 1/2	54.3	43	20	57	472	2	*1
1. 9/16	56.8	43	20	57	525	2	*1
1. 5/8	58	43	22	57	555	2	*1
1.13/16	64.3	43	23	62	710	2	*1
1. 7/8	66.8	53	23	62	868	2	*2

16410M (mm)	D ₁ (mm)	D ₂ (mm)	H (mm)	L (mm)	(g)	(pcs.)	
16	28.8	44	11	50	367	5	*1
17	30	44	12	50	355	5	*1
18	31.3	44	13	50	372	5	*1
19	32.5	44	13	50	360	5	*1
21	35	44	15	50	374	5	*1
22	36.3	44	15	50	373	5	*1
24	38.8	44	16	50	370	5	*1
27	42.5	44	16	50	375	5	*1
30	46.3	44	18	53	410	5	*1
32	48.8	44	19	53	428	5	*1
33	50	44	20	55	470	5	*1
36	53.8	44	20	55	498	5	*1

*1 C-Ring=C61, Pin/O-Ring=A61/B61



16410M

Surface Drive Sockets
Surface Drive Steckschlüssel
Douilles, Surface Drive

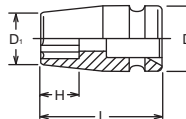

Z-SERIES
HAND
TITANIUM
ACCESSORIES
SCREWDRIVERS
IMPACT
SLEEVE-DRIVE
PROTECTOR
INDUSTRIAL
AUTOMOTIVE
MOTORCYCLE
CONSTRUCTION
SPARE PART

Impact Sockets Impact Steckschlüssel Douilles Impact

3/4"

Z-SERIES

HAND

TITANIUM

ACCESSORIES

SCREWDRIVERS

IMPACT

SLEEVE-DRIVE

PROTECTOR

INDUSTRIAL

AUTOMOTIVE

MOTORCYCLE

CONSTRUCTION

SPARE PART

16425



TORX® Sockets
TORX® Steckschlüssel
Douilles TORX®

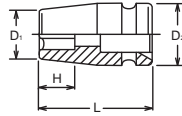

16425 (E)	D ₁ (mm)	D ₂ (mm)	H (mm)	L (mm)	(g)	(pcs.)	
E18	26.3	44	13	50	355	5	*1
E20	28.8	44	14.4	50	370	5	*1
E22	31.3	44	15.5	50	390	5	*1
E24	32.5	44	17	50	390	5	*1
E26	35	44	18.8	60	460	5	*1
E28	36.3	44	25.2	60	465	5	*1
E30	38.8	44	25.2	60	480	5	*1
E32	41.3	44	25.2	60	480	5	*1

*1 C-Ring=C61, Pin/O-Ring=A61/B61 → P268-269

TORX® (E)

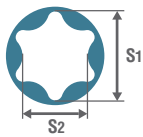

E	E4	E5	E6	E7	E8	E10	E11	E12	E14	E16	E18	E20	E22	E24	E26	E28	E30	E32
S ₁ (ref. mm)	3.7	4.6	5.6	6.1	7.4	9.3	9.9	11.0	12.8	14.6	16.5	18.3	20.1	22.0	23.7	25.5	27.3	29.0
S ₂ (ref. mm)	2.7	3.3	4.0	4.3	5.3	6.8	7.1	7.9	9.2	10.5	11.9	13.2	14.8	15.7	17.5	18.3	20.0	21.3

16425 (EPL)



TORXPLUS® Sockets
TORXPLUS® Steckschlüssel
Douilles TORXPLUS®

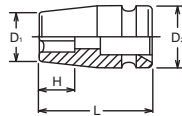

16425 (EPL)	D ₁ (mm)	D ₂ (mm)	H (mm)	L (mm)	(g)	(pcs.)	
24EPL	32.5	44	12.2	50	427	5	*1
26EPL	35	44	14.2	60	467	5	*1
28EPL	36.3	44	15.2	60	467	5	*1
30EPL	38.8	44	16.1	60	472	5	*1
32EPL	41.3	44	16.1	60	488	5	*1

*1 C-Ring=C61, Pin/O-Ring=A61/B61 → P268-269

TORXplus® (EP/EPL)

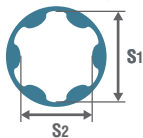

EP/EPL	8EP	10EP	12EP	14EP	16EP	18EP	20EP	22EP	24EP	26EP	28EP	30EP	32EP
S ₁ (ref. mm)	7.4	9.3	11.0	12.8	14.6	16.5	18.3	20.1	22.0	23.7	25.5	27.3	29.0
S ₂ (ref. mm)	5.7	7.1	8.5	9.8	11.2	12.7	14.0	15.4	16.8	18.2	19.6	20.9	22.3

16301X



6-point Semi-Deep Sockets, Thin Walled
6-kant Steckschlüssel mittel lang, dünnwandig
Douilles à paroi mince semi-longues, 6-pans

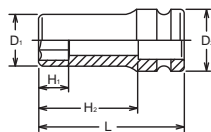

16301X (mm)	D ₁ (mm)	D ₂ (mm)	H ₁ (mm)	H ₂ (mm)	L (mm)	(g)	(pcs.)	
17	28	43	17	49	75	370	2	*1
18	29.3	43	18	49	75	380	2	*1
19	30.5	43	19	49	75	393	2	*1
20	31.8	43	20	49	75	400	2	*1
21	33	43	21	49	75	408	2	*1
22	34.3	43	22	49	75	418	2	*1
23	35.5	43	23	49	75	425	2	*1
24	36.8	43	24	49	75	435	2	*1
25	38	43	25	49	75	449	2	*1
26	39.3	43	26	49	75	455	2	*1
27	40.5	43	27	48	75	464	2	*1
28	41.8	43	28	48	75	479	2	*1
29	43	43	29	48	75	489	2	*1
30	44.3	43	30	48	75	506	2	*1
31	45.5	43	31	47	75	518	2	*1
32	46.8	43	32	47	75	535	2	*1
33	48	43	33	47	75	550	2	*1
35	50.5	43	35	46	75	585	2	*1
36	51.8	43	36	46	75	603	2	*1
37	53	43	37	46	75	645	2	*1
38	54.3	43	38	50	80	691	2	*1
40	56.8	43	38	50	80	725	2	*1
41	58	43	38	49	80	755	2	*1
46	64.3	43	38	48	80	808	2	*1

*1 C-Ring=C61, Pin/O-Ring=A61/B61 → P268-269

3/4"

Impact Sockets
Impact Steckschlüssel
Douilles Impact

16300M / 16300A

6-point Sockets, deep
6-kant Steckschlüssel, lang
Douilles longues, 6-pans

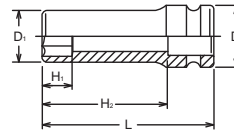

16300M (mm)	D ₁ (mm)	D ₂ (mm)	H ₁ (mm)	H ₂ (mm)	L (mm)	(g)	(pcs.)	
14	26.3	44	14	74	100	497	2	*1
16	28.8	44	16	74	100	524	2	*1
17	30	44	17	74	100	544	2	*1
18	31.3	44	18	74	100	642	2	*1
19	32.5	44	19	74	100	655	2	*1
20	33.8	44	20	74	100	680	2	*1
21	35	44	21	74	100	700	2	*1
22	36.3	44	22	74	100	700	2	*1
23	37.5	44	23	74	100	720	2	*1
24	38.8	44	24	74	100	705	2	*1
25	40	44	25	74	100	715	2	*1
26	41.3	44	26	74	100	710	2	*1
27	42.5	44	27	73	100	710	2	*1
28	43.8	44	28	73	100	800	2	*1
29	45	44	29	73	100	835	2	*1
30	46.3	44	30	73	100	840	2	*1
31	47.5	44	31	72	100	815	2	*1
32	48.8	44	32	72	100	875	2	*1
33	50	44	33	72	100	920	2	*1
34	51.3	44	34	72	100	950	2	*1
35	52.5	44	35	71	100	980	2	*1
36	53.8	44	36	71	100	960	2	*1
37	55	44	37	71	100	970	2	*1
38	56.3	44	38	70	100	990	2	*1
40	58.8	44	38	70	100	1060	2	*1
41	60	44	38	69	100	1120	2	*1
42	61.3	44	38	69	100	1153	2	*1
43	62.5	44	38	69	100	1200	2	*1
44	63.8	44	38	68	100	1220	2	*1
46	66.3	44	38	68	100	1305	2	*1
48	68.8	54	38	68	100	1480	2	*2
50	71.3	54	61	-	100	1469	2	*2
55	77.5	54	59	-	100	1620	2	*2
60	83.8	54	56	-	100	1835	2	*2

*1 C-Ring=C81, Pin/O-Ring=A61/B61
*2 C-Ring=C81, Pin/O-Ring=A62/B62



16300A (inch)	D ₁ (mm)	D ₂ (mm)	H ₁ (mm)	H ₂ (mm)	L (mm)	(g)	(pcs.)	
3/4	32.5	44	19	74	100	655	2	*1
13/16	35	44	21	74	100	700	2	*1
7/8	36.3	44	22	74	100	700	2	*1
15/16	38.8	44	24	74	100	705	2	*1
1	40	44	25	74	100	715	2	*1
1. 1/16	42.5	44	27	73	100	765	2	*1
1. 1/8	45	44	29	73	100	835	2	*1
1. 3/16	46.3	44	30	73	100	840	2	*1
1. 1/4	48.8	44	32	72	100	875	2	*1
1. 5/16	51.3	44	34	72	100	950	2	*1
1. 3/8	52.5	44	35	71	100	980	2	*1
1. 7/16	55	44	37	71	100	970	2	*1
1. 1/2	56.3	44	38	70	100	990	2	*1
1. 9/16	58.8	44	38	70	100	1060	2	*1
1. 5/8	60	44	38	69	100	1120	2	*1
1.11/16	62.5	44	38	69	100	1200	2	*1
1. 3/4	65	44	38	68	100	1284	2	*1
1.13/16	66.3	44	38	68	100	1305	2	*1
1. 7/8	68.8	54	38	67	100	1561	2	*2
2	72.5	54	60	-	100	1516	2	*2

16305M

12-point Sockets, deep
12-kant Steckschlüssel, lang
Douilles longues, 12-pans

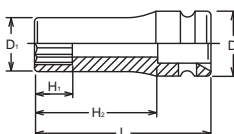

16305M (mm)	D ₁ (mm)	D ₂ (mm)	H ₁ (mm)	H ₂ (mm)	L (mm)	(g)	(pcs.)	
14	26.3	44	14	74	100	500	2	*1
16	28.8	44	16	74	100	522	2	*1
17	30	44	17	74	100	544	2	*1
18	31.3	44	18	74	100	600	2	*1
19	32.5	44	19	74	100	655	2	*1
21	35	44	21	74	100	700	2	*1
22	36.3	44	22	74	100	700	2	*1
23	37.5	44	23	74	100	720	2	*1
24	38.8	44	24	74	100	715	2	*1
26	41.3	44	26	74	100	760	2	*1
27	42.5	44	27	73	100	765	2	*1
28	43.8	44	28	73	100	800	2	*1
29	45	44	29	73	100	835	2	*1
30	46.3	44	30	73	100	840	2	*1
32	48.8	44	32	72	100	875	2	*1
33	50	44	33	72	100	920	2	*1
34	51.3	44	34	72	100	950	2	*1
35	52.5	44	35	71	100	980	2	*1
36	53.8	44	36	71	100	960	2	*1
38	56.3	44	38	70	100	990	2	*1
41	60	44	38	69	100	1120	2	*1
46	66.3	44	38	68	100	1305	2	*1
50	71.3	54	61	-	100	1469	2	*2

*1 C-Ring=C61, Pin/O-Ring=A61/B61
*2 C-Ring=C81, Pin/O-Ring=A62/B62



Z-SERIES
HAND
TITANIUM
ACCESSORIES
SCREWDRIVERS
IMPACT
SLEEVE-DRIVE
PROTECTOR
INDUSTRIAL
AUTOMOTIVE
MOTORCYCLE
CONSTRUCTION
SPARE PART

Impact Sockets Impact Steckschlüssel Douilles Impact

3/4"

Z-SERIES

HAND

TITANIUM

SCREWDRIVERS ACCESSORIES

IMPACT

SLEEVE-DRIVE

PROTECTOR

INDUSTRIAL

AUTOMOTIVE

MOTORCYCLE

CONSTRUCTION

SPARE PART

16301M / 16301A

6-point Deep Sockets, Thin Walled
6-kant Steckschlüssel, dünnwandig
Douilles à paroi mince longues, 6-pans

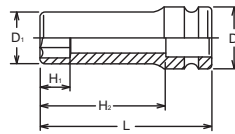

16301A (inch)	D ₁ (mm)	D ₂ (mm)	H ₁ (mm)	H ₂ (mm)	L (mm)	(g)	(pcs.)	
11/16	28	43	17	74	100	470	2	*1
3/4	30.5	43	19	74	100	480	2	*1
13/16	33	43	21	74	100	505	2	*1
7/8	34.3	43	22	74	100	528	2	*1
15/16	36.8	43	24	74	100	560	2	*1
1	38	43	25	74	100	581	2	*1
1. 1/16	40.5	43	27	73	100	610	2	*1
1. 1/8	43	43	29	73	100	650	2	*1
1. 3/16	44.3	43	30	73	100	670	2	*1
1. 1/4	46.8	43	32	72	100	715	2	*1
1. 5/16	49.3	43	34	72	100	790	2	*1
1. 3/8	50.5	43	35	71	100	785	2	*1
1. 7/16	53	43	37	71	100	850	2	*1
1. 1/2	54.3	43	38	70	100	885	2	*1
1. 9/16	56.8	43	38	70	100	925	2	*1
1. 5/8	58	43	38	69	100	970	2	*1
1.13/16	64.3	43	38	68	100	1150	2	*1

16301M (mm)	D ₁ (mm)	D ₂ (mm)	H ₁ (mm)	H ₂ (mm)	L (mm)	(g)	(pcs.)	
16	26.8	43	16	74	100	435	2	*1
17	28	43	17	74	100	470	2	*1
18	29.3	43	18	74	100	475	2	*1
19	30.5	43	19	74	100	480	2	*1
20	31.8	43	20	74	100	491	2	*1
21	33	43	21	74	100	505	2	*1
22	34.3	43	22	74	100	528	2	*1
23	35.5	43	23	74	100	542	2	*1
24	36.8	43	24	74	100	560	2	*1
25	38	43	25	74	100	581	2	*1
26	39.3	43	26	74	100	600	2	*1
27	40.5	43	27	73	100	610	2	*1
28	41.8	43	28	73	100	639	2	*1
29	43	43	29	73	100	650	2	*1
30	44.3	43	30	73	100	670	2	*1
31	45.5	43	31	72	100	690	2	*1
32	46.8	43	32	72	100	715	2	*1
33	48	43	33	72	100	750	2	*1
34	49.3	43	34	72	100	772	2	*1
35	50.5	43	35	71	100	785	2	*1
36	51.8	43	36	71	100	830	2	*1
37	53	43	37	71	100	850	2	*1
38	54.3	43	38	70	100	885	2	*1
39	55.5	43	38	70	100	910	2	*1
40	56.8	43	38	70	100	925	2	*1
41	58	43	38	69	100	970	2	*1
42	59.3	43	38	69	100	990	2	*1
46	64.3	43	38	68	100	1150	2	*1
50	69.2	53	62	-	100	1328	2	*2

*1 C-Ring=C61, Pin/O-Ring=A61/B61 → P268-269
*2 C-Ring=C81, Pin/O-Ring=A62/B62

16310M

Surface Drive Sockets, deep
Surface Drive Steckschlüssel, lang
Douilles longues, Surface Drive

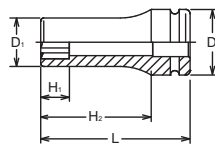

16310M (mm)	D ₁ (mm)	D ₂ (mm)	H ₁ (mm)	H ₂ (mm)	L (mm)	(g)	(pcs.)	
15	27.5	44	15	74	100	500	2	*1
16	28.8	44	16	74	100	524	2	*1
17	30	44	17	74	100	544	2	*1
18	31.3	44	18	74	100	642	2	*1
19	32.5	44	19	74	100	655	2	*1
21	35	44	21	74	100	700	2	*1
22	36.3	44	22	74	100	700	2	*1
24	38.8	44	24	74	100	705	2	*1
27	42.5	44	27	73	100	710	2	*1
30	46.3	44	30	73	100	840	2	*1
32	48.8	44	32	72	100	875	2	*1
33	50	44	33	72	100	920	2	*1
36	53.8	44	34	71	100	960	2	*1

*1 C-Ring=C61, Pin/O-Ring=A61/B61 → P268-269

16325

TORX® Deep Sockets
TORX® Steckschlüssel, lang
Douilles longues TORX®

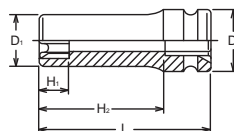

16325 (E)	D ₁ (mm)	D ₂ (mm)	H ₁ (mm)	H ₂ (mm)	L (mm)	(g)	(pcs.)	
E18	26.3	44	13	74	100	520	2	*1
E20	28.8	44	14.4	74	100	560	2	*1
E22	31.3	44	15.5	74	100	600	2	*1
E24	32.5	44	17	74	100	630	2	*1
E26	35.0	44	18.8	74	100	660	2	*1
E28	36.3	44	25.2	74	100	670	2	*1
E30	38.8	44	25.2	75	100	730	2	*1
E32	41.3	44	25.2	75	100	777	2	*1

*1 C-Ring=C61, Pin/O-Ring=A61/B61 → P268-269

16106-16 (mm)	D (mm)	H (mm)	L (mm)	(g)	(pcs.)	⚠
10	44	24	76	416	2	*1
12	44	24	76	422	2	*1
13	44	24	76	426	2	*1
14	44	24	76	430	2	*1
16	44	24	76	439	2	*1
17	44	24	76	443	2	*1 ⚠
18	44	24	76	448	2	*1 ⚠
19	44	24	76	450	2	*1 ⚠
22	44	24	76	473	2	*1 ⚠

16106-16 (inch)	D (mm)	H (mm)	L (mm)	(g)	(pcs.)	⚠
1/2	44	24	76	426	2	*1
9/16	44	24	76	430	2	*1
5/8	44	24	76	439	2	*1
3/4	44	24	76	450	2	*1 ⚠

*1 C-Ring=C61, Pin/O-Ring=A61/B61 → P268-269

16106-16 (T)	D (mm)	H (mm)	L (mm)	(g)	(pcs.)	⚠
T55	44	34	86	427	2	*1
T60	44	34	86	434	2	*1
T70	44	34	86	443	2	*1

*1 C-Ring=C61, Pin/O-Ring=A61/B61 → P268-269

16106-16 (XZN)	D (mm)	H (mm)	L (mm)	(g)	(pcs.)	⚠
M14	44	44	96	453	2	*1
M16	44	44	96	463	2	*1
M18	44	44	96	473	2	*1

*1 C-Ring=C61, Pin/O-Ring=A61/B61 → P268-269

16106	D ₁ (mm)	D ₂ (mm)	H (mm)	L (mm)	(g)	(pcs.)	⚠
16106	32	44	16	52	370	2	*1

*1 C-Ring=C61, Pin/O-Ring=A61/B61 → P268-269

16106-SC

Replacement Screw : M6x10, 3mm

16106-16

Bit Holder complete with Bit, Inhex
Klingenhalter komplett mit Klinge, Innensechskant
Porte embouts avec bit 6-pans creux

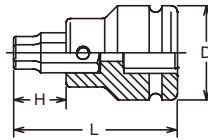

The items with ⚠ have larger output sizes than 16mm Input drive.
Due to this design the maximum output torque rating is less than standard.

Die mit ⚠ gekennzeichneten Artikel haben größere Abtriebsgrößen als der 16mm Antrieb.
Aufgrund dieser Konstruktion ist das maximale Abtriebsdrehmoment geringer als der Standardwert.
Les articles marqués d'un ⚠ ont des tailles de sortie plus importantes que l'entraînement d'entrée 16mm.

En raison de cette conception, le couple de sortie maximum est inférieur au couple standard.

16106-16(T)

TORX® Bit Sockets
TORX® Bit-Steckschlüssel
Douilles tournevis, TORX®

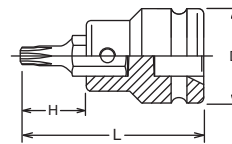

16106-16(XZN)

XZN Bit Sockets
Steckschlüssel für XZN Schrauben
Douilles tournevis pour empreinte XZN

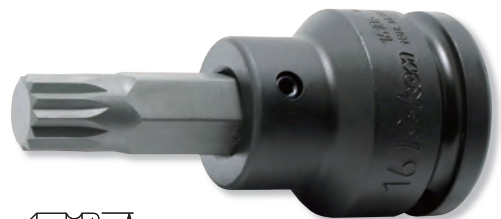
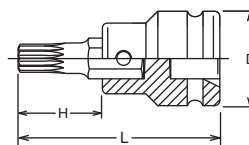

16106

Bit Holder
Klingenhalter
Porte-embout

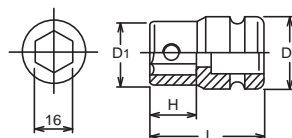

Impact Sockets Impact Steckschlüssel Douilles Impact

3/4"

Z-SERIES
HAND
TITANIUM
SCREWDRIVERS
ACCESSORIES
IMPACT
SLEEVE-DRIVE
PROTECTOR
INDUSTRIAL
AUTOMOTIVE
MOTORCYCLE
CONSTRUCTION
SPARE PART

107-16

Bits for Inhex Screws
Klingen für Innensechskant-Schrauben
Embouts pour vis 6-pans males creux



107-16 (mm)	L (mm)	(g)	(pcs.)
10	40	46	10
12	40	52	10
13	40	56	10
14	40	60	10
16	40	69	10
17	40	73	10
18	40	78	10
19	40	80	10
22	40	97	10

107-16 (inch)	L (mm)	(g)	(pcs.)
3/8	40	45	10
7/16	40	53	10
1/2	40	56	10
9/16	40	60	10
5/8	40	69	10
3/4	40	80	10

107-16(L100) (mm)	L (mm)	R (mm)	(g)	(pcs.)
10	100	13	118	10
12	100	15	141	10
14	100	-	163	10
17	100	-	185	10
19	100	-	228	10
22	100	-	293	10

107-16 (T)

TORX® Bits
TORX® Klingen
Embouts, TORX®

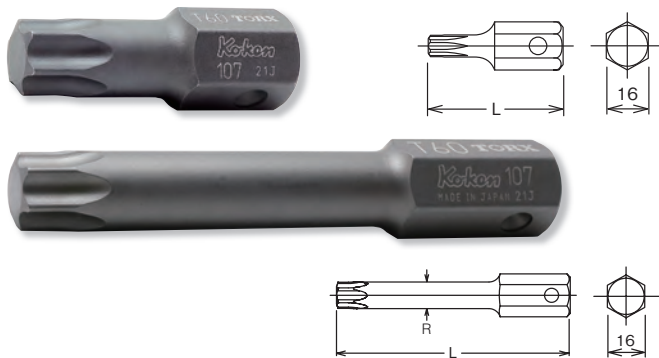

107-16 (T)	L (mm)	(g)	(pcs.)
T45	50	45	10
T50	50	50	10
T55	50	57	10
T60	50	64	10
T70	50	73	10

107-16(L100) (T)	L (mm)	R (mm)	(g)	(pcs.)
T45	100	8	95	10
T50	100	9	100	10
T55	100	11.4	104	10
T60	100	13.4	123	10
T70	100	15.7	148	10

107-16 (IP)

TORXPLUS® Bits
TORXPLUS® Klingen
Embouts TORXPLUS®



107-16 (IP)	L (mm)	(g)	(pcs.)
55IP	50	57	10
60IP	50	64	10
70IP	50	73	10

107-16 (XZN)

Bits XZN
Klingen XZN
Embouts de vissage, XZN

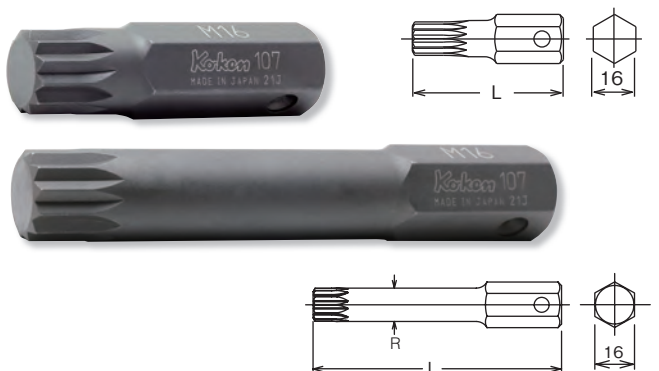

107-16 (XZN)	L (mm)	(g)	(pcs.)
M14	60	83	10
M16	60	93	10
M18	60	103	10

107-16(L100) (XZN)	L (mm)	R (mm)	(g)	(pcs.)
M14	100	13.4	126	10
M16	100	15.8	153	10
M18	100	17.1	173	10

⚠ The items with ⚠ have larger output sizes than 16mm Input drive. Due to this design the maximum output torque rating is less than standard.
Die mit ⚠ gekennzeichneten Artikel haben größere Abtriebsgrößen als der 16mm Antrieb. Aufgrund dieser Konstruktion ist das maximale Abtriebsdrehmoment geringer als der Standardwert.
Les articles marqués d'un ⚠ ont des tailles de sortie plus importantes que l'entraînement d'entrée 16mm. En raison de cette conception, le couple de sortie maximum est inférieur au couple standard.

16107-22 (mm)	D (mm)	H (mm)	L (mm)	(g)	(pcs.)	⚠
19	44	28	88	670	2	*1
22	44	28	88	692	2	*1
24	44	28	88	706	2	*1
27	44	28	88	730	2	*1
30	44	28	88	757	2	*1
32	44	28	93	783	2	*1

*1 C-Ring=C61, Pin/O-Ring=A61/B61 → P268-269

16107	D ₁ (mm)	D ₂ (mm)	H (mm)	L (mm)	(g)	(pcs.)	⚠
16107	44	44	22	60	530	2	*1

*1 C-Ring=C61, Pin/O-Ring=A61/B61 → P268-269

16107-SC

Replacement Screw : M8x14, 4mm

107-22 (mm)	L (mm)	(g)	(pcs.)
17	50	120	10
19	50	140	10
22	50	162	10
24	50	176	10
27	50	200	10
30	50	227	10
32	55	243	10

107-22 (inch)	L (mm)	(g)	(pcs.)
5/8	50	120	10
3/4	50	140	10
7/8	50	162	10
1	50	190	10
1. 1/4	55	243	10

107-22(L140) (mm)	L (mm)	(g)	(pcs.)
17	140	431	5
19	140	441	5
22	140	460	5
24	140	513	5

107-22 (T)	L (mm)	(g)	(pcs.)
T 70	60	129	10
T 80	60	141	10
T 90	60	155	10
T100	60	170	10

107-22(L140) (T)	L (mm)	(g)	(pcs.)
T 70	140	395	5
T 80	140	407	5
T 90	140	420	5
T100	140	434	5

16107-22

Bit Holder complete with Bit
Klingenhalter, komplett mit Klinge
Porte embouts avec bit

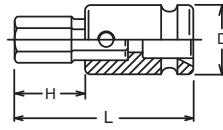

16107

Bit Holder
Klingenhalter
Porte embouts

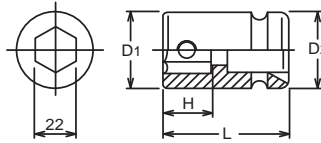

107-22

Bits for Inhex Screws
Klingen für Innsechskant-Schrauben
Embouts pour vis 6-pans males creux

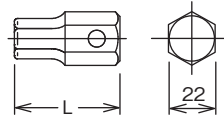

107-22 (T)

TORX® Bits
TORX® Klingen
Embouts, TORX®

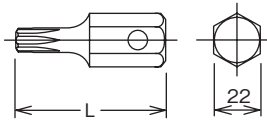

⚠ The items with ⚠ have larger output sizes than 22mm Input drive.
Due to this design the maximum output torque rating is less than standard.
Die mit ⚠ gekennzeichneten Artikel haben größere Abtriebsgrößen als der 22mm Antrieb.
Aufgrund dieser Konstruktion ist das maximale Abtriebsdrehmoment geringer als der Standardwert.
Les articles marqués d'un ⚠ ont des tailles de sortie plus importantes que l'entraînement d'entrée
22mm. En raison de cette conception, le couple de sortie maximum est inférieur au couple standard.

16760

Extension Bars
Verlängerungen
Rallonges

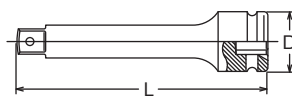

	D (mm)	L (mm)	(g)	(pcs.)	⚠
16760-150	44	150	775	1	*1
16760-175	44	175	870	1	*1
16760-200	44	200	955	1	*1
16760-250	44	250	1150	1	*1
16760-330	44	330	1460	1	*1

*1 C-Ring=C61, Pin/O-Ring=A61/B61 → P268-269

TORX is a registered trademark of CAMCAR Innovations.
TORX ist ein registriertes Markenzeichen der Firma CAMCAR Innovations.
TORX est une marque déposée de CAMCAR Innovations.

Impact Sockets Impact Steckschlüssel Douilles Impact

3/4"

Z-SERIES
HAND
TITANIUM
SCREWDRIVERS ACCESSORIES
IMPACT
SLEEVE-DRIVE
PROTECTOR
INDUSTRIAL
AUTOMOTIVE
MOTORCYCLE
CONSTRUCTION
SPARE PART

16666AL Adaptor (Quick Release)
Verbindungsstück (Quick Release)
Adaptateur (Quick Release) ⚠

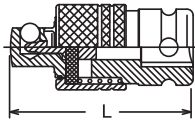

	L (mm)	(g)	(pcs.)	
16666AL	75	660	2	*1

*1 C-Ring=C61, Pin/O-Ring=A61/B61 → P268-269

Lock & Quick Release

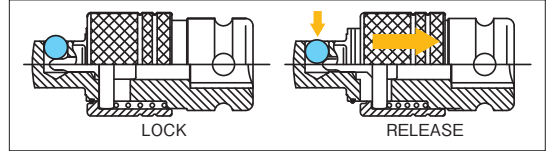

⚠ You may not hold the sliding part while moving to avoid heating up by friction and reduction by wear.

Bitte das gleitende Teil während der Bewegung nicht festhalten, um eine Erhitzung durch Reibung und durch Verschleiß zu vermeiden.

Vous ne devez pas tenir la partie coulissante pendant le déplacement afin d'éviter l'échauffement par frottement et la réduction par usure la réduction par l'usure.

	(sq.)	(sq.)	L (mm)	(g)	(pcs.)	
16644AL	3/4"	1/2"	70	240	2	*1

*1 Pin/O-Ring=A51/B51 → P269

16644AL Adaptor (Quick Release)
Verbindungsstück (Quick Release)
Adaptateur (Quick Release) ⚠

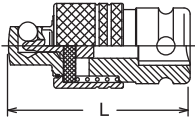

16770 Universal Joint
Gelenk-Einsatz
Joint articulé

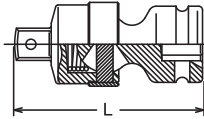

	L (mm)	(g)	(pce.)	
16770	106	790	1	*1
16771	95	720	1	*1

*1 C-Ring=C61, Pin/O-Ring=A61/B61 → P268-269

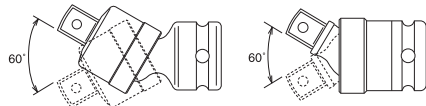

Our ball joints are spring-loaded and can therefore be adjusted to an angle of max. 30°.

Unsere Kugelgelenke sind federbelastet dadurch sind sie auf einen Winkel von max 30° einstellbar.

Nos joints à rotule sont à ressort et peuvent donc être réglés jusqu'à un angle de 30° maximum.

16771 Universal Joint
Gelenk-Einsatz
Joint articulé

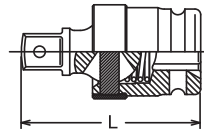

16644A Adaptors
Verbindungsstücke
Réducteurs ⚠

16655A

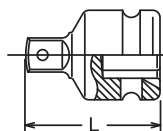

	TYPE	(sq.)	(sq.)	L (mm)	(g)	(pcs.)	
16644A-P	Pin	3/4"	1/2"	54	310	5	*1
16644A-B	Ball	3/4"	1/2"	54	310	5	*1
16644A	Hole	3/4"	1/2"	54	310	5	*1

	(sq.)	(sq.)	L (mm)	(g)	(pce.)	
16655A	3/4"	5/8"	55.5	336	5	*1

*1 C-Ring=C61, Pin/O-Ring=A61/B61 → P268-269

⚠ Adapting down from bigger square drive to smaller square drive may lead to excessive torque load and possibly cause breakage. Always stay within safe torque of the smaller square drive.

Die mit ⚠ gekennzeichneten Artikel können bei Überbelastung zu Bruch gehen. Aus Gründen Ihrer eigenen Sicherheit sollten die betreffenden Werkzeuge nie ruckartig, sondern nach und nach belastet werden, um Bruch und damit verbundene mögliche Verletzungen zu vermeiden.

Il est possible d'appliquer aux articles marqués ⚠ des couples de serrage susceptibles d'occasionner leur rupture. Pour votre propre sécurité, veuillez toujours appliquer la charge d'une manière uniforme et progressive. Ceci pour éviter ruptures et accidents.

16688A Adaptor
Verbindungsstück
Augmentateur

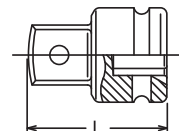

	(sq.)	(sq.)	L (mm)	(g)	(pce.)	
16688A	3/4"	1"	62	435	1	*1
16688A-250	3/4"	1"	250	1400	1	*1
16688A-330	3/4"	1"	330	1880	1	*1

*1 C-Ring=C61, Pin/O-Ring=A61/B61 → P268-269

16688A-250 / -330 Adaptors
Verbindungsstücke
Réducteurs

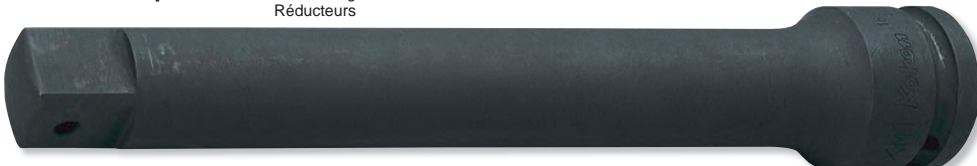

3/4"

Impact Sockets
Impact Steckschlüssel
Douilles Impact

16201M-00 / 16201A-00

Socket Sets
Steckschlüssel Sätze
Jeux de clés à douilles



16201M-00 13 Pieces Set/△=6,800g

METAL CASE:W320xH110xT70mm

Sockets



16400M 6-pt. Sockets
19, 21, 22, 23, 24, 26, 27, 30, 32,
33, 36, 38, 41

16201A-00 11 Pieces Set/△=6,000g

METAL CASE:W290xH120xT70mm

Sockets



16400A 6-pt. Sockets
3/4, 7/8, 15/16, 1, 1.1/16, 1.1/8, 1.1/4,
1.5/16, 1.3/8, 1.7/16, 1.1/2

16201M-01 / 16201A-01

Socket Sets
Steckschlüssel Sätze
Jeux de clés à douilles



16201M-01 13 Pieces Set/△=6,000g

METAL CASE:W320xH110xT70mm

Sockets



16401M 6-pt. Sockets, Thin-walled
19, 21, 22, 23, 24, 26, 27, 30, 32,
33, 36, 38, 41

16201A-01 11 Pieces Set/△=5,400g

METAL CASE:W290xH120xT70mm

Sockets



16401A 6-pt. Sockets, Thin-walled
3/4, 7/8, 15/16, 1, 1.1/16, 1.1/8, 1.1/4,
1.5/16, 1.3/8, 1.7/16, 1.1/2

16245M

Socket Sets
Steckschlüssel Sätze
Jeux de clés à douilles



16245M 17 Pieces Set/△=12,000g

METAL CASE:W590xH127xT72mm

Sockets

Accessories



16400M 6-pt. Sockets
19, 21, 22, 24, 27, 29, 30,
32, 33, 35, 36, 38, 41, 46,
50

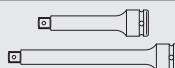

16760-175

16760-330

Impact Sockets Impact Steckschlüssel Douilles Impact

1"

18400M / 18400A



6-point Sockets
6-kant Steckschlüssel
Douilles 6-pans

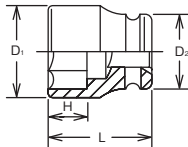

18400M (mm)	D ₁ (mm)	D ₂ (mm)	H (mm)	L (mm)	(g)	(pcs.)	⊕
17	32.8	54	12	57	579	2	*1
18	34	54	13	57	586	2	*1
19	35.3	54	13	57	590	2	*1
20	36.5	54	14	57	600	2	*1
21	37.8	54	15	57	605	2	*1
22	39	54	15	57	620	2	*1
23	40.3	54	16	57	615	2	*1
24	41.5	54	16	57	627	2	*1
25	42.8	54	16	57	620	2	*1
26	44	54	16	57	640	2	*1
27	45.3	54	16	57	627	2	*1
28	46.5	54	16	57	640	2	*1
29	47.8	54	18	57	657	2	*1
30	49	54	21	62	657	2	*1
31	50.3	54	21	62	687	2	*1
32	51.5	54	21	62	685	2	*1
33	52.8	54	21	62	685	2	*1
34	54	54	21	62	690	2	*1
35	55.3	54	21	62	710	2	*1
36	56.5	54	21	62	712	2	*1
37	57.8	54	21	62	735	2	*1
38	59	54	25	66	720	2	*1
39	60.3	54	25	66	820	2	*1
40	61.5	54	25	66	850	2	*1
41	62.8	54	25	66	850	2	*1
42	64	54	25	66	905	2	*1
43	65.3	54	27	68	977	2	*1
44	66.5	54	27	68	970	2	*1
45	67.8	54	27	68	963	2	*1
46	69	54	29	70	1010	2	*1
47	70.3	66	36	70	1235	2	*2
48	71.5	66	35	70	1228	2	*2
50	74	66	35	70	1302	2	*2
52	76.5	66	40	75	1423	2	*2
54	79	66	40	75	1492	2	*2
55	80.3	66	39	75	1501	2	*2
56	81.5	66	39	75	1520	2	*2
58	84	66	39	75	1586	2	*2
60	86.5	66	39	75	1651	2	*2
62	89	66	38	75	1685	2	*2
63	90.3	66	38	75	1661	2	*2
65	92.8	66	38	75	1915	2	*2
67	95.3	66	38	75	1872	2	*2
68	96.5	66	37	75	1877	1	*2
70	99	66	37	75	1944	1	*2
75	105.3	86	37	80	2675	1	*3
77	107.8	86	37	80	2890	1	*3
80	111.5	86	41	85	2996	1	*3
85	117.8	86	37	90	3378	1	*3
90	124	86	40	95	3871	1	*3
95	130.3	86	43	100	4500	1	*3
100	136.5	86	47	105	5000	1	*3

18400A (inch)	D ₁ (mm)	D ₂ (mm)	H (mm)	L (mm)	(g)	(pcs.)	⊕
11/16	32.8	54	12	57	579	2	*1
3/4	35.3	54	13	57	590	2	*1
13/16	37.8	54	15	57	605	2	*1
7/8	39	54	15	57	620	2	*1
15/16	41.5	54	16	57	627	2	*1
1	42.8	54	16	57	620	2	*1
1. 1/16	45.3	54	16	57	627	2	*1
1. 3/32	46.5	54	16	57	640	2	*1
1. 1/8	47.8	54	18	57	657	2	*1
1. 3/16	49	54	21	62	657	2	*1
1. 1/4	51.5	54	21	62	685	2	*1
1. 5/16	54	54	21	62	690	2	*1
1. 3/8	55.3	54	21	62	710	2	*1
1. 7/16	57.8	54	21	62	735	2	*1
1.15/32	57.8	62	21	62	735	2	*1
1. 1/2	59	54	25	66	720	2	*1
1. 9/16	61.5	54	25	66	850	2	*1
1. 5/8	62.8	54	25	66	850	2	*1
1.11/16	65.3	54	27	68	977	2	*1
1. 3/4	67.8	54	27	68	963	2	*1
1.13/16	69	54	29	70	1010	2	*1
1. 7/8	71.5	66	35	70	1228	2	*2
1.15/16	72.8	66	35	70	1238	2	*2
2	75.3	66	35	70	1297	2	*2
2. 1/16	76.5	66	40	75	1423	2	*2
2. 1/8	79	66	40	75	1492	2	*2
2. 3/16	80.3	66	39	75	1501	2	*2
2. 1/4	82.8	66	39	75	1583	2	*2
2. 5/16	84	66	39	75	1586	2	*2
2. 3/8	86.5	66	39	75	1651	2	*2
2. 7/16	89	66	38	75	1685	2	*2
2. 1/2	91.5	66	38	75	1780	2	*2
2. 9/16	92.8	66	38	75	1915	2	*2
2. 5/8	95.3	66	38	75	1872	2	*2
2.11/16	96.5	66	37	75	1877	1	*2
2. 3/4	99	66	37	75	1944	1	*2
2.13/16	101.5	86	37	80	2705	1	*3
2. 7/8	102.8	86	38	80	2629	1	*3
2.15/16	105.3	86	37	80	2675	1	*3
3	106.5	86	37	80	2705	1	*3
3. 1/16	109	86	42	85	2967	1	*3
3. 1/8	111.5	86	41	85	2996	1	*3
3. 1/4	115.3	86	44	90	3328	1	*3
3. 3/8	119	86	36	90	3389	1	*3
3. 1/2	124	86	40	95	3871	1	*3
3. 3/4	130.3	86	43	100	4377	1	*3
3. 7/8	135.3	86	47	105	5000	1	*3
4	137.8	86	46	105	5152	1	*3

*1 C-Ring=C81, Pin/O-Ring=A81/B81

*2 C-Ring=C82, Pin/O-Ring=A82/B82

*3 C-Ring=C83, Pin/O-Ring=A83/B83

→ P268-269

18405M (mm)	D ₁ (mm)	D ₂ (mm)	H (mm)	L (mm)	(g)	(pcs.)	
24	41.5	54	16	57	627	2	*1
27	45.3	54	16	57	607	2	*1
30	49	54	21	62	657	2	*1
32	51.5	54	21	62	685	2	*1
33	52.8	54	21	62	690	2	*1
35	55.3	54	21	62	690	2	*1
36	56.5	54	21	62	692	2	*1
38	59	54	25	66	700	2	*1
40	61.5	54	25	66	830	2	*1
41	62.8	54	25	66	905	2	*1
46	69	54	29	70	990	2	*1
50	74	66	35	70	1258	2	*2
55	80.3	66	39	75	1475	2	*2
56	81.5	66	39	75	1493	2	*2
60	86.5	66	39	75	1621	2	*2
65	92.8	66	38	75	1885	2	*2
70	99	66	37	75	1960	1	*2
75	105.3	86	37	80	2675	1	*3
80	111.5	86	41	85	2996	1	*3

18405A (inch)	D ₁ (mm)	D ₂ (mm)	H (mm)	L (mm)	(g)	(pcs.)	
3/4	35.3	54	13	57	590	2	*1
7/8	39	54	15	57	620	2	*1
1	42.8	54	16	57	620	2	*1
1. 1/8	47.8	54	18	57	660	2	*1
1. 3/16	49	54	21	62	660	2	*1
1. 1/4	51.5	54	21	62	690	2	*1
1. 3/8	55.3	54	21	62	710	2	*1
1. 7/16	57.8	54	21	62	735	2	*1
1. 1/2	59	54	25	66	720	2	*1
1. 3/4	67.8	54	27	68	970	2	*1
1.15/16	72.8	66	35	70	1208	2	*1

*1 C-Ring=C81, Pin/O-Ring=A81/B81

*2 C-Ring=C82, Pin/O-Ring=A82/B82



*3 C-Ring=C83, Pin/O-Ring=A83/B83

18405M / 18405A

12-point Sockets
12-kant Steckschlüssel
Douilles 12-pans

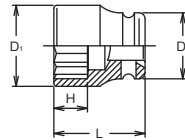

18401M (mm)	D ₁ (mm)	D ₂ (mm)	H (mm)	L (mm)	(g)	(pcs.)	
17	29.8	53	12	57	481	2	*1
18	31	53	13	57	488	2	*1
19	32.3	53	13	57	492	2	*1
20	33.5	53	14	57	505	2	*1
21	34.8	53	15	57	512	2	*1
22	36	53	15	57	520	2	*1
24	38.5	53	16	57	520	2	*1
26	41	53	16	57	533	2	*1
27	42.3	53	16	57	540	2	*1
29	44.8	53	18	57	560	2	*1
30	46	53	21	62	572	2	*1
32	48.5	53	21	62	600	2	*1
33	49.8	53	21	62	613	2	*1
35	52.3	53	21	62	630	2	*1
36	53.5	53	21	62	635	2	*1
38	56	53	25	66	705	2	*1
41	59.8	53	25	66	740	2	*1
42	61	53	25	66	803	2	*1
46	66	53	29	70	900	2	*1
47	67.3	65	36	70	1153	2	*2
50	71	65	35	70	1235	2	*2

18401A (inch)	D ₁ (mm)	D ₂ (mm)	H (mm)	L (mm)	(g)	(pcs.)	
11/16	29.8	53	12	57	481	2	*1
3/4	32.3	53	13	57	492	2	*1
13/16	34.8	53	15	57	512	2	*1
7/8	36	53	15	57	520	2	*1
15/16	38.5	53	16	57	520	2	*1
1. 1/16	42.3	53	16	57	540	2	*1
1. 3/16	46	53	21	62	572	2	*1
1. 1/4	48.5	53	21	62	600	2	*1
1. 3/8	52.3	53	21	62	630	2	*1
1. 1/2	56	53	25	66	705	2	*1
1. 5/8	59.8	53	25	66	740	2	*1
1.13/16	66	53	29	70	900	2	*1

*1 C-Ring=C81, Pin/O-Ring=A81/B81

*2 C-Ring=C82, Pin/O-Ring=A82/B82



18401M / 18401A

6-point Sockets, Thin Walled
6-kant Steckschlüssel, dünnwandig
Douilles à paroi mince, 6-pans

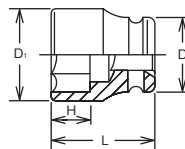

Impact Sockets Impact Steckschlüssel Douilles Impact

1"



Z-SERIES
HAND
TITANIUM
SCREWDRIVERS
ACCESSORIES
IMPACT
SLEEVE-DRIVE
PROTECTOR
INDUSTRIAL
AUTOMOTIVE
MOTORCYCLE
CONSTRUCTION
SPARE PART

18410M Surface Drive Sockets Surface Drive Steckschlüssel Douilles, Surface Drive

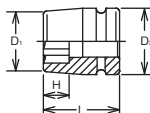

SURFACE DRIVE







18410M (mm)	D ₁ (mm)	D ₂ (mm)	H (mm)	L (mm)	 (g)	 (pcs.)	
19	35.3	54	13	57	570	2	*1
22	39	54	15	57	620	2	*1
24	41.5	54	16	57	627	2	*1
27	45.3	54	16	57	627	2	*1
30	49	54	21	62	657	2	*1
32	51.5	54	21	62	685	2	*1
33	52.8	54	21	62	685	2	*1
36	56.5	54	21	62	712	2	*1
41	62.8	54	25	66	850	2	*1

*1 C-Ring=C81, Pin/O-Ring=A81/B81 → P268-269

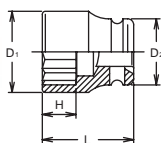
18405M (D) Sockets for Cardan Shafts Steckschlüssel für Gelenkwellen Douilles pour arbres à cardan

No Warranty 
Keine Garantie
Sans Garantie



18405M (D) (mm)	D ₁ (mm)	D ₂ (mm)	H (mm)	L (mm)	 (g)	 (pcs.)	
50(D68)	68	66	35	70	890	2	*2
55(D76)	76	66	39	75	1130	2	*2
65(D87)	87	66	38	75	1344	2	*2

*2 C-Ring=C82, Pin/O-Ring=A82/B82 → P268-269

Items in this catalogue marked  can be loaded to torque values which may cause breakage. In the interest of your own safety always apply load evenly and progressively to avoid breakage and possible injury.

Die mit  gekennzeichneten Artikel können bei Überbelastung zu Bruch gehen. Aus Gründen Ihrer eigenen Sicherheit sollten die betreffenden Werkzeuge nie ruckartig, sondern nach und nach belastet werden, um Bruch und damit verbundene mögliche Verletzungen zu vermeiden.

Il est possible d'appliquer aux articles marqués  des couples de serrage susceptibles d'occasionner leur rupture. Pour votre propre sécurité, veuillez toujours appliquer la charge d'une manière uniforme et progressive. Ceci pour éviter ruptures et accidents.



18301X (mm)	D ₁ (mm)	D ₂ (mm)	H ₁ (mm)	H ₂ (mm)	L (mm)	⚖️ (g)	📦 (pcs.)	⚡
17	29.8	53	17	48	80	635	2	*1
19	32.3	53	19	48	80	655	2	*1
21	34.8	53	21	48	80	680	2	*1
22	36	53	22	48	80	686	2	*1
24	38.5	53	24	48	80	693	2	*1
27	42.3	53	27	48	80	745	2	*1
30	46	53	30	48	80	761	2	*1
32	48.5	53	32	53	85	770	2	*1
33	49.8	53	33	53	85	781	2	*1
35	52.3	53	35	53	85	800	2	*1
36	53.5	53	36	52	85	808	2	*1
38	56	53	38	52	85	865	2	*1
41	59.8	53	38	51	85	937	2	*1
46	66	53	38	50	85	1032	2	*1
50	71	65	55	-	85	1458	2	*2



18301X

6-point Semi-Deep Sockets, Thin Walled
6-kant Steckschlüssel mittel lang, dünnwandig
Douilles à paroi mince semi-longues, 6-pans

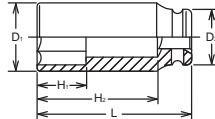

*1 C-Ring=C81, Pin/O-Ring=A81/B81
*2 C-Ring=C82, Pin/O-Ring=A82/B82 → P268-269

18300M / 18300A

6-point Sockets, deep
6-kant Steckschlüssel, lang
Douilles 6-pans, longues



18300M (mm)	D ₁ (mm)	D ₂ (mm)	H ₁ (mm)	H ₂ (mm)	L (mm)	⚖️ (g)	📦 (pcs.)	⚡
17	32.8	54	17	77	108	1000	2	*1
19	35.3	54	19	77	108	1010	2	*1
20	36.5	54	20	77	108	1010	2	*1
21	37.8	54	21	77	108	1010	2	*1
22	39	54	22	77	108	1010	2	*1
23	40.3	54	23	77	108	1063	2	*1
24	41.5	54	24	77	108	1060	2	*1
25	42.8	54	25	77	108	1085	2	*1
26	44	54	26	77	108	1133	2	*1
27	45.3	54	27	77	108	1125	2	*1
28	46.5	54	28	77	108	1140	2	*1
29	47.8	54	29	77	108	1120	2	*1
30	49	54	30	77	108	1179	2	*1
31	50.3	54	31	77	108	1125	2	*1
32	51.5	54	32	77	108	1200	2	*1
33	52.8	54	33	77	108	1200	2	*1
34	54	54	34	77	108	1280	2	*1
35	55.3	54	35	77	108	1300	2	*1
36	56.5	54	36	76	108	1280	2	*1
37	57.8	54	37	76	108	1320	2	*1
38	59	54	38	76	108	1423	2	*1
40	61.5	54	38	75	108	1415	2	*1
41	62.8	54	38	75	108	1450	2	*1
42	64	54	38	75	108	1550	2	*1
44	66.5	54	38	74	108	1636	2	*1
45	67.8	54	38	74	108	1660	2	*1
46	69	54	38	74	108	1680	2	*1
48	71.5	66	67	-	108	1729	2	*2
50	74	66	66	-	108	1879	2	*2
52	76.5	66	65	-	108	2000	2	*2
55	80.3	66	63	-	108	2088	2	*2
60	86.5	66	60	-	108	2290	2	*2
65	92.8	66	58	-	108	2643	2	*2
70	99	66	55	-	108	2792	1	*2
75	105.3	86	52	-	108	3646	1	*3
80	111.5	86	49	-	108	4039	1	*3
85	117.8	86	59	-	108	4000	1	*3
90	124	86	57	-	108	4200	1	*3
95	130.3	86	55	-	108	4400	1	*3

18300A (inch)	D ₁ (mm)	D ₂ (mm)	H ₁ (mm)	H ₂ (mm)	L (mm)	⚖️ (g)	📦 (pcs.)	⚡
11/16	32.8	54	17	77	108	978	2	*1
3/4	35.3	54	19	77	108	1010	2	*1
7/8	39	54	22	77	108	1010	2	*1
15/16	41.5	54	24	77	108	1060	2	*1
1	42.8	54	25	77	108	1085	2	*1
1. 1/16	45.3	54	27	77	108	1125	2	*1
1. 1/8	47.8	54	29	77	108	1120	2	*1
1. 3/16	49	54	30	77	108	1179	2	*1
1. 1/4	51.5	54	32	77	108	1200	2	*1
1. 5/16	54	54	34	77	108	1280	2	*1
1. 3/8	55.3	54	35	77	108	1300	2	*1
1. 7/16	57.8	54	37	76	108	1320	2	*1
1. 1/2	59	54	38	76	108	1423	2	*1
1. 9/16	61.5	54	38	75	108	1415	2	*1
1. 5/8	62.8	54	38	75	108	1450	2	*1
1.11/16	65.3	54	38	74	108	1577	2	*1
1. 3/4	67.8	54	38	74	108	1660	2	*1
1.13/16	69	54	38	74	108	1680	2	*1
1. 7/8	71.5	66	67	-	108	1729	2	*2
1.15/16	72.8	66	67	-	108	1799	2	*2
2	75.3	66	66	-	108	1834	2	*2
2. 1/16	76.5	66	65	-	108	2000	2	*2
2. 1/8	79	66	64	-	108	2044	2	*2
2. 3/16	80.3	66	63	-	108	2088	2	*2
2. 1/4	82.8	66	62	-	108	2153	2	*2
2. 5/16	84	66	61	-	108	2225	2	*2
2. 3/8	86.5	66	60	-	108	2290	2	*2
2. 7/16	89	66	59	-	108	2364	2	*2
2. 1/2	91.5	66	58	-	108	2581	2	*2
2. 9/16	92.8	66	58	-	108	2643	2	*2
2. 5/8	95.3	66	56	-	108	2711	1	*2
2. 3/4	99	66	55	-	108	2792	1	*2
2. 7/8	102.8	86	53	-	108	3600	1	*3
2.15/16	105.3	86	52	-	108	3646	1	*3
3	106.5	86	51	-	108	3677	1	*3
3. 1/16	109	86	50	-	108	3939	1	*3
3. 1/8	111.5	86	49	-	108	4039	1	*3
3. 3/16	112.8	86	48	-	108	4170	1	*3

*1 C-Ring=C81, Pin/O-Ring=A81/B81
*2 C-Ring=C82, Pin/O-Ring=A82/B82
*3 C-Ring=C83, Pin/O-Ring=A83/B83 → P268-269

Z-SERIES
HAND
TITANIUM
ACCESSORIES
SCREWDRIVERS
IMPACT
SLEEVE-DRIVE
PROTECTOR
INDUSTRIAL
AUTOMOTIVE
MOTORCYCLE
CONSTRUCTION
SPARE PART

Impact Sockets Impact Steckschlüssel Douilles Impact

1"

Z-SERIES
HAND
TITANIUM
SCREWDRIVERS ACCESSORIES
IMPACT
SLEEVE-DRIVE
PROTECTOR
INDUSTRIAL
AUTOMOTIVE
MOTORCYCLE
CONSTRUCTION
SPARE PART

18301M / 18301A

6-point Deep Sockets, Thin Walled
6-kant Steckschlüssel, dünnwandig
Douilles à paroi mince longues, 6-pans

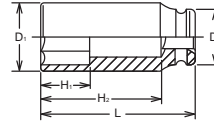

18301A (inch)	D ₁ (mm)	D ₂ (mm)	H ₁ (mm)	H ₂ (mm)	L (mm)	(g)	(pcs.)	
11/16	29.8	53	17	77	108	692	2	*1
3/4	32.3	53	19	77	108	725	2	*1
13/16	34.8	53	21	77	108	750	2	*1
7/8	36	53	22	77	108	770	2	*1
15/16	38.5	53	24	77	108	800	2	*1
1	39.8	53	25	77	108	828	2	*1
1. 1/16	42.3	53	27	77	108	860	2	*1
1. 1/8	44.8	53	29	77	108	909	2	*1
1. 3/16	46	53	30	77	108	910	2	*1
1. 1/4	48.5	53	32	77	108	970	2	*1
1. 9/32	49.8	53	33	77	108	980	2	*1
1. 5/16	51	53	34	77	108	1014	2	*1
1. 3/8	52.3	53	35	77	108	986	2	*1
1. 7/16	54.8	53	37	76	108	1000	2	*1
1. 1/2	56	53	38	76	108	1025	2	*1
1. 9/16	58.5	53	38	75	108	1200	2	*1
1. 5/8	59.8	53	38	75	108	1213	2	*1
1.11/16	62.3	53	38	74	108	1285	2	*1
1. 3/4	64.8	53	38	74	108	1360	2	*1
1.13/16	66	53	38	74	108	1400	2	*1
2	72.3	65	65	-	108	1850	2	*2

18301M (mm)	D ₁ (mm)	D ₂ (mm)	H ₁ (mm)	H ₂ (mm)	L (mm)	(g)	(pcs.)	
17	29.8	53	17	77	108	692	2	*1
18	31	53	18	77	108	710	2	*1
19	32.3	53	19	77	108	725	2	*1
20	33.5	53	20	77	108	740	2	*1
21	34.8	53	21	77	108	750	2	*1
22	36	53	22	77	108	770	2	*1
23	37.3	53	23	77	108	780	2	*1
24	38.5	53	24	77	108	800	2	*1
26	41	53	26	77	108	830	2	*1
27	42.3	53	27	77	108	860	2	*1
29	44.8	53	29	77	108	880	2	*1
30	46	53	30	77	108	910	2	*1
32	48.5	53	32	77	108	970	2	*1
33	49.8	53	33	77	108	980	2	*1
34	51	53	34	77	108	980	2	*1
35	52.3	53	35	77	108	986	2	*1
36	53.5	53	36	76	108	992	2	*1
38	56	53	38	76	108	1025	2	*1
39	57.3	53	38	76	108	1130	2	*1
41	59.8	53	38	75	108	1213	2	*1
42	61	53	38	75	108	1245	2	*1
43	62.3	53	38	74	108	1400	2	*1
46	66	53	38	74	108	1400	2	*1
50	71	65	38	-	108	1746	2	*2
55	77.3	65	62	-	108	1963	2	*2
60	83.5	65	59	-	108	2220	2	*2
65	89.8	65	56	-	108	2689	2	*2
70	96	65	55	-	108	2630	1	*2

18104M

Special Sockets for Spring Clamps
Steckschlüssel für Federbriden
Douilles pour brides de ressorts

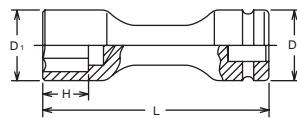

18104M (mm)	D ₁ (mm)	D ₂ (mm)	H (mm)	L (mm)	(g)	(pcs.)	
24	41.5	54	24	170	1327	1	*1
27	45.3	54	27	170	1375	1	*1
28	46.5	54	28	170	1390	1	*1
30	49	54	30	170	1407	1	*1
32	51.5	54	32	170	1537	1	*1
33	52.8	54	33	170	1590	1	*1
34	54	54	34	170	1670	1	*1
36	56.5	54	36	170	1800	1	*1

18310M

Surface Drive Sockets, deep
Surface Drive Steckschlüssel, lang
Douilles longues, Surface Drive

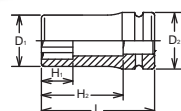

18310M (mm)	D ₁ (mm)	D ₂ (mm)	H ₁ (mm)	H ₂ (mm)	L (mm)	(g)	(pcs.)	
21	37.8	54	21	77	108	1010	2	*1
24	41.5	54	24	77	108	1060	2	*1
27	45.3	54	27	77	108	1125	2	*1
30	49	54	30	77	108	1179	2	*1
32	51.5	54	32	77	108	1200	2	*1
33	52.8	54	33	77	108	1200	2	*1
36	56.5	54	36	76	108	1280	2	*1
41	62.8	54	38	75	108	1450	2	*1

*1 C-Ring=C81, Pin/O-Ring=A81/B81 → P268-269

18106-16 (mm)	D (mm)	H (mm)	L (mm)	(g)	(pcs.)	⚡
10	54	24	92	686	2	*1
12	54	24	92	692	2	*1
13	54	24	92	696	2	*1
14	54	24	92	700	2	*1
16	54	24	92	709	2	*1
17	54	24	92	713	2	*1
18	54	24	92	718	2	*1
19	54	24	92	764	2	*1
22	54	24	92	781	2	*1

18106-16 (inch)	D (mm)	H (mm)	L (mm)	(g)	(pcs.)	⚡
1/2	54	24	92	696	2	*1
9/16	54	24	92	700	2	*1
5/8	54	24	92	709	2	*1
3/4	54	24	92	764	2	*1

*1 C-Ring=C81, Pin/O-Ring=A81/B81 → P268-269

18106-16 (T)	D (mm)	H (mm)	L (mm)	(g)	(pcs.)	⚡
T55	54	34	102	697	2	*1
T60	54	34	102	704	2	*1
T70	54	34	102	713	2	*1

*1 C-Ring=C81, Pin/O-Ring=A81/B81 → P268-269

18106-16 (XZN)	D (mm)	H (mm)	L (mm)	(g)	(pcs.)	⚡
M14	54	44	112	723	2	*1
M16	54	44	112	733	2	*1
M18	54	44	112	743	2	*1

*1 C-Ring=C81, Pin/O-Ring=A81/B81 → P268-269

18106	D ₁ (mm)	D ₂ (mm)	H (mm)	L (mm)	(g)	(pcs.)	⚡
18106	32	54	16	68	640	2	*1

*1 C-Ring=C81, Pin/O-Ring=A81/B81 → P268-269

16106-SC

Replacement Screw : M6x10, 3mm



18106-16

Bit Holder complete with Bit, Inhex
Klingenhalter komplett mit Klinge, Innensechskant
Porte embouts avec bit 6-pans creux

⚠ The items with ⚠ have larger output sizes than 16mm Input drive.
Due to this design the maximum output torque rating is less than standard.
Die mit ⚠ gekennzeichneten Artikel haben größere Abtriebsgrößen als der 16mm Antrieb.
Aufgrund dieser Konstruktion ist das maximale Abtriebsdrehmoment geringer als der Standardwert.
Les articles marqués d'un ⚠ ont des tailles de sortie plus importantes que l'entraînement d'entrée
16mm. En raison de cette conception, le couple de sortie maximum est inférieur au couple standard.

18106-16(T)

TORX® Bit Sockets
TORX® Bit-Steckschlüssel
Douilles tournevis, TORX®

18106-16(XZN)

XZN Bit Sockets
Steckschlüssel für XZN Schrauben
Douilles tournevis pour empreinte XZN

18106

Bit Holder
Klingenhalter
Porte embouts

Impact Sockets Impact Steckschlüssel Douilles Impact

1"

Z-SERIES
HAND
TITANIUM
SCREWDRIVERS
ACCESSORIES
IMPACT
SLEEVE-DRIVE
PROTECTOR
INDUSTRIAL
AUTOMOTIVE
MOTORCYCLE
CONSTRUCTION
SPARE PART

107-16 Bits for Inhex Screws Klingen für Innensechskant-Schrauben Emboutis pour vis 6-pans males creux

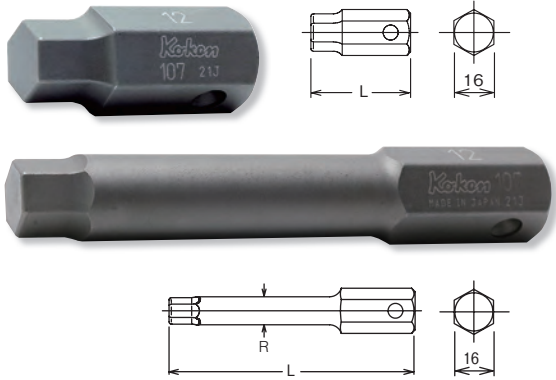

107-16 (mm)	L (mm)	(g)	(pcs.)
10	40	46	10
12	40	52	10
13	40	56	10
14	40	60	10
16	40	69	10
17	40	73	10
18	40	78	10
19	40	80	10
22	40	97	10

107-16 (inch)	L (mm)	(g)	(pcs.)
3/8	40	45	10
7/16	40	53	10
1/2	40	56	10
9/16	40	60	10
5/8	40	69	10
3/4	40	80	10

107-16(L100) (mm)	L (mm)	R (mm)	(g)	(pcs.)
10	100	13	118	10
12	100	15	141	10
14	100	-	163	10
17	100	-	185	10
19	100	-	228	10
22	100	-	293	10

107-16 (T) TORX® Bits TORX® Klingen Emboutis TORX®

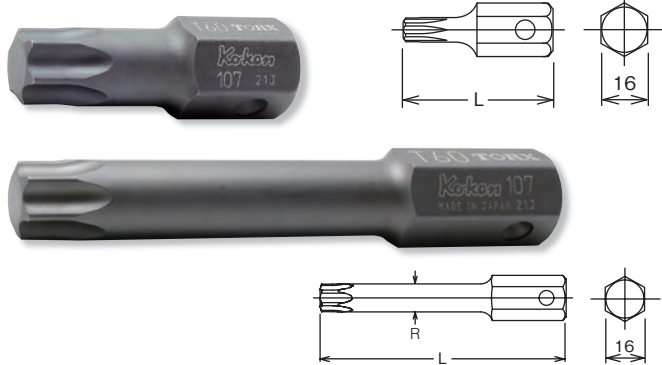

107-16 (T)	L (mm)	(g)	(pcs.)
T45	50	45	10
T50	50	50	10
T55	50	57	10
T60	50	64	10
T70	50	73	10

107-16(L100) (T)	L (mm)	R (mm)	(g)	(pcs.)
T45	100	8	95	10
T50	100	9	100	10
T55	100	11.4	104	10
T60	100	13.4	123	10
T70	100	15.7	148	10

107-16 (IP) TORXPLUS® Bits TORXPLUS® Klingen Emboutis TORXPLUS®





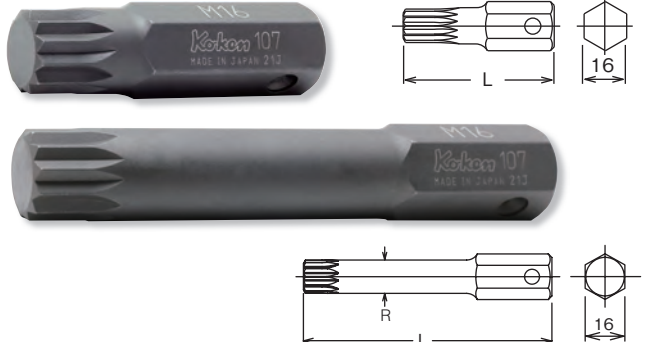

107-16 (IP)	L (mm)	(g)	(pcs.)
55IP	50	57	10
60IP	50	64	10
70IP	50	73	10

107-16 (XZN) Bits XZN Klingen XZN Emboutis de vissage, XZN



107-16 (XZN)	L (mm)	(g)	(pcs.)
M14	60	83	10
M16	60	93	10
M18	60	103	10

107-16(L100) (XZN)	L (mm)	R (mm)	(g)	(pcs.)
M14	100	13.4	126	10
M16	100	15.8	153	10
M18	100	17.1	173	10

 The items with  have larger output sizes than 16mm Input drive. Due to this design the maximum output torque rating is less than standard.
Die mit  gekennzeichneten Artikel haben größere Abtriebsgrößen als der 16mm Antrieb. Aufgrund dieser Konstruktion ist das maximale Abtriebsdrehmoment geringer als der Standardwert.
Les articles marqués d'un  ont des tailles de sortie plus importantes que l'entraînement d'entrée 16mm. En raison de cette conception, le couple de sortie maximum est inférieur au couple standard.

18107-22 (mm)	D (mm)	H (mm)	L (mm)	(g)	(pcs.)	
19	54	28	98	910	2	*1
22	54	28	98	932	2	*1
24	54	28	98	946	2	*1
27	54	28	98	986	2	*1
30	54	28	98	1008	2	*1
32	54	28	103	1029	2	*1

*1 C-Ring=C81, Pin/O-Ring=A81/B81 → P268-269



18107	D1 (mm)	D2 (mm)	H (mm)	L (mm)	(g)	(pcs.)	
18107	44	54	22	70	770	2	*1

*1 C-Ring=C81, Pin/O-Ring=A81/B81 → P268-269

16107-SC

Replacement Screw : M8x14, 4mm

107-22 (mm)	L (mm)	(g)	(pcs.)
17	50	120	10
19	50	140	10
22	50	162	10
24	50	176	10
27	50	200	10
30	50	227	10
32	55	243	10

107-22 (inch)	L (mm)	(g)	(pcs.)
5/8	50	120	10
3/4	50	140	10
7/8	50	162	10
1	50	190	10
1. 1/4	55	243	10

107-22(L140) (mm)	L (mm)	(g)	(pcs.)
17	140	431	5
19	140	441	5
22	140	460	5
24	140	513	5

107-22 (T)	L (mm)	(g)	(pcs.)
T 70	60	129	10
T 80	60	141	10
T 90	60	155	10
T100	60	170	10

107-22(L140) (T)	L (mm)	(g)	(pcs.)
T 70	140	395	5
T 80	140	407	5
T 90	140	420	5
T100	140	434	5

18107-22



Bit Holder complete with Bit, Inhex
Klingenhalter komplett mit Klinge, Innensechskant
Porte embouts avec bit 6-pans creux

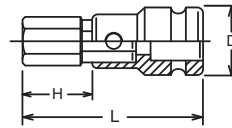

18107



Bit Holder
Klingenhalter
Porte embouts

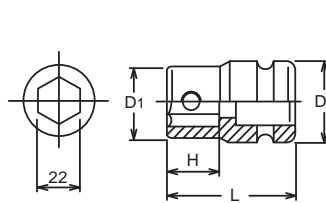

107-22



Bits for Inhex Screws
Klingen für Innensechskant-Schrauben
Embouts pour vis 6-pans males creux

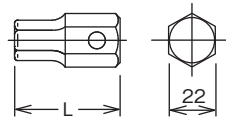

107-22 (T)



TORX® Bits
TORX® Klingen
Embouts, TORX®

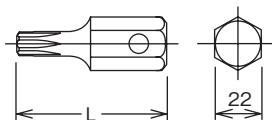

⚠ The items with ⚠ have larger output sizes than 22mm Input drive.
Due to this design the maximum output torque rating is less than standard.
Die mit ⚠ gekennzeichneten Artikel haben größere Abtriebsgrößen als der 22mm Antrieb.
Aufgrund dieser Konstruktion ist das maximale Abtriebsdrehmoment geringer als der Standardwert.
Les articles marqués d'un ⚠ ont des tailles de sortie plus importantes que l'entraînement d'entrée
22mm. En raison de cette conception, le couple de sortie maximum est inférieur au couple standard.

Impact Sockets Impact Steckschlüssel Douilles Impact

1"

Z-SERIES
HAND
TITANIUM
SCREWDRIVERS ACCESSORIES
IMPACT
SLEEVE-DRIVE
PROTECTOR
INDUSTRIAL
AUTOMOTIVE
MOTORCYCLE
CONSTRUCTION
SPARE PART

18108-32

Bit Holder complete with Bit, Inhex
Klingenhalter komplett mit Klinge, Innensechskant
Porte embouts avec bit 6-pans creux

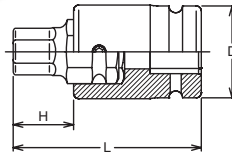

18108-32 (mm)	D (mm)	H (mm)	L (mm)	(g)	(pcs.)	
19	54	30	105	1230	2	*1
22	54	30	105	1250	2	*1
24	54	30	105	1260	2	*1
27	54	30	105	1290	2	*1
30	54	30	105	1320	2	*1
32	54	30	105	1340	2	*1
36	54	30	105	1390	2	*1

*1 C-Ring=C81, Pin/O-Ring=A81/B81 → P268-269



The items with have larger output sizes than 32mm Input drive. Due to this design the maximum output torque rating is less than standard.

Die mit gekennzeichneten Artikel haben größere Abtriebsgrößen als der 32mm Antrieb. Aufgrund dieser Konstruktion ist das maximale Abtriebsdrehmoment geringer als der Standardwert.

Les articles marqués d'un ont des tailles de sortie plus importantes que l'entraînement d'entrée 32mm.

En raison de cette conception, le couple de sortie maximum est inférieur au couple standard.

18108

Bit Holder
Klingenhalter
Porte embouts

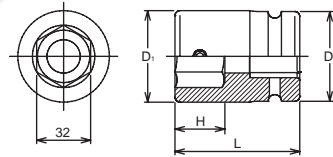

18108	D ₁ (mm)	D ₂ (mm)	H (mm)	L (mm)	(g)	(pcs.)	
18108	55	54	30	75	930	2	*1

*1 C-Ring=C81, Pin/O-Ring=A81/B81 → P268-269

18108-SC



Replacement Screw : M8x12, 4mm

107-32

Bit for Inhex Screws
Klingen für Innensechskant-Schrauben
Embouts pour vis 6-pans mâle creux

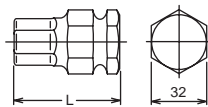

107-32 (mm)	L (mm)	(g)	(pcs.)
19	60	300	10
22	60	320	10
24	60	330	10
27	60	360	10
30	60	390	10
32	60	410	10
36	60	460	10



18760

Extension Bars
Verlängerungen
Rallonges

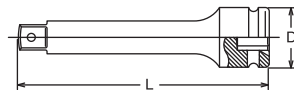

	D (mm)	L (mm)	(g)	(pcs.)	
18760-175	54	175	1400	1	*1
18760-200	54	200	1580	1	*1
18760-250	54	250	1885	1	*1
18760-330	54	330	2380	1	*1

*1 C-Ring=C81, Pin/O-Ring=A81/B81 → P268-269

	L (mm)	(g)	(pcs.)	⚠
18888AL	95	980	2	*1

*1 C-Ring=C81, Pin/O-Ring=A81/B81 → P268-269

Lock & Quick Release

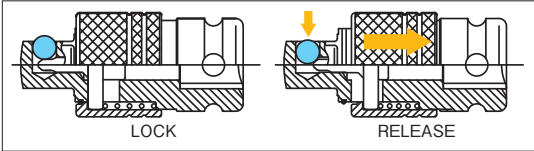

⚠ You may not hold the sliding part while moving to avoid heating up by friction and reduction by wear.

Bitte das gleitende Teil während der Bewegung nicht festhalten, um eine Erhitzung durch Reibung und durch Verschleiß zu vermeiden.

Vous ne devez pas tenir la partie coulissante pendant le déplacement afin d'éviter l'échauffement par frottement et la réduction par usure la réduction par l'usure.

	L (mm)	(g)	(pce.)	⚠
18770	127	1350	1	*1
18771	115	1210	1	*1

*1 C-Ring=C81, Pin/O-Ring=A81/B81 → P268-269

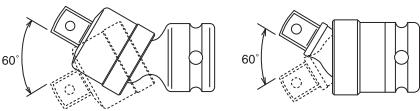

Our ball joints are spring-loaded and can therefore be adjusted to an angle of max. 30°.

Unsere Kugelgelenke sind federbelastet dadurch sind sie auf einen Winkel von max 30° einstellbar.

Nos joints à rotule sont à ressort et peuvent donc être réglés jusqu'à un angle de 30° maximum.

	(sq.)	(sq.)	L (mm)	(g)	(pce.)	⚠
18866A	1"	3/4"	66.5	580	1	*1
18866A-200	1"	3/4"	200	1100	1	*1

*1 C-Ring=C81, Pin/O-Ring=A81/B81 → P268-269

⚠ Adapting down from bigger square drive to smaller square drive may lead to excessive torque load and possibly cause breakage. Always stay within safe torque of the smaller square drive.

Die mit ⚠ gekennzeichneten Artikel können bei Überbelastung zu Bruch gehen. Aus Gründen Ihrer eigenen Sicherheit sollten die betreffenden Werkzeuge nie ruckartig, sondern nach und nach belastet werden, um Bruch und damit verbundene mögliche Verletzungen zu vermeiden.

Il est possible d'appliquer aux articles marqués ⚠ des couples de serrage susceptibles d'occasionner leur rupture. Pour votre propre sécurité, veuillez toujours appliquer la charge d'une manière uniforme et progressive. Ceci pour éviter ruptures et accidents.

	(sq.)	(sq.)	L (mm)	(g)	(pce.)	⚠
18877A	1"	1.1/2"	80	935	1	*1

*1 C-Ring=C81, Pin/O-Ring=A81/B81 → P268-269



18888AL

Adaptor (Quick Release)
Verbindungsstück (Quick Release) ⚠
Adaptateur (Quick Release)

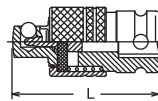

18770

Universal Joint
Gelenk-Einsatz
Joint articulé

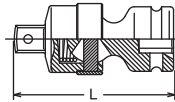

18771

Universal Joint
Gelenk-Einsatz
Joint articulé

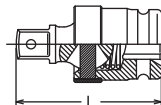

18866A

Adaptors
Verbindungsstücke
Réducteurs

No Warranty
Keine Garantie
Sans Garantie ⚠

18866A-200

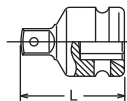

18877A

Adaptor
Verbindungsstück
Augmentateur

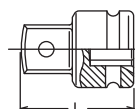

17400M / 17400A

6-point Sockets
6-kant Steckschlüssel
Douilles 6-pans

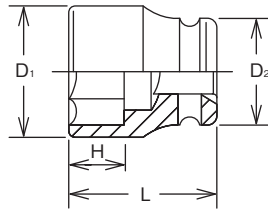

17400M (mm)	D ₁ (mm)	D ₂ (mm)	H (mm)	L (mm)	(g)	(pce.)	⊕
36	62	86	20	77	2126	1	*1
41	68	86	22	80	2346	1	*1
42	70	86	22	80	2330	1	*1
46	74	86	26	84	2360	1	*1
50	79	86	27	84	2400	1	*1
52	82	86	38	84	2340	1	*1
54	84	86	38	84	2340	1	*1
55	85	86	44	90	2450	1	*1
57	87	86	43	90	2460	1	*1
58	88	86	44	90	2510	1	*1
60	91	86	43	90	2640	1	*1
65	97	86	48	95	3050	1	*1
70	103	86	52	100	3350	1	*1
75	108	86	56	105	3700	1	*1
80	115	86	60	110	4240	1	*1
85	122	86	60	110	4550	1	*1
90	128	86	60	112	4840	1	*1
95	135	127	52	112	7660	1	*2
100	140	127	53	115	7700	1	*2
105	146	127	57	120	8000	1	*2
110	153	127	60	124	9200	1	*2
115	160	127	62	128	10700	1	*2
120	166	127	64	132	11200	1	*2
125	173	127	67	136	13000	1	*2
130	180	127	69	140	14200	1	*2
135	186	127	73	145	14940	1	*2
140	190	127	76	150	15600	1	*2
150	200	127	83	160	16500	1	*2

17400A (inch)	D ₁ (mm)	D ₂ (mm)	H (mm)	L (mm)	(g)	(pce.)	⊕
1. 5/8	68	86	22	80	2346	1	*1
1.11/16	71	86	22	80	2300	1	*1
1. 3/4	73	86	22	80	2290	1	*1
1.13/16	74	86	26	84	2360	1	*1
1. 7/8	77	86	26	84	2440	1	*1
1.15/16	79	86	27	84	2400	1	*1
2	80	86	27	84	2420	1	*1
2. 1/16	82	86	38	84	2340	1	*1
2. 1/8	84	86	38	84	2340	1	*1
2. 3/16	85	86	44	90	2450	1	*1
2. 1/4	87	86	43	90	2460	1	*1
2. 5/16	88	86	44	90	2510	1	*1
2. 3/8	91	86	43	90	2640	1	*1
2. 7/16	93	86	47	95	2860	1	*1
2. 1/2	96	86	47	95	3000	1	*1
2. 9/16	97	86	48	95	3050	1	*1
2. 5/8	100	86	51	100	3300	1	*1
2.11/16	101	86	51	100	3300	1	*1
2. 3/4	103	86	52	100	3350	1	*1
2.13/16	105	86	55	105	3670	1	*1
2. 7/8	106	86	55	105	3610	1	*1
2.15/16	108	86	56	105	3700	1	*1
3	108	86	55	105	3680	1	*1
3. 1/8	115	86	60	110	4240	1	*1
3. 1/4	118	86	59	110	4370	1	*1
3. 3/8	123	86	60	110	4570	1	*1
3. 1/2	128	86	60	112	4840	1	*1
3. 5/8	132	86	52	112	5500	1	*1
3. 3/4	135	127	52	112	7660	1	*2
3. 7/8	140	127	53	115	7700	1	*2
4	146	127	57	120	8000	1	*2
4. 1/8	146	127	57	120	8000	1	*2
4. 1/4	153	127	60	124	9200	1	*2
4. 1/2	160	127	62	128	10700	1	*2
4. 5/8	166	127	64	132	11200	1	*2
4. 3/4	168	127	64	132	11200	1	*2
4. 7/8	173	127	67	136	13000	1	*2
5	180	127	69	140	14200	1	*2
5. 1/4	186	127	73	145	14940	1	*2
6	205	127	88	165	16500	1	*2
6. 1/2	205	127	94	175	17500	1	*2

*1 C-Ring=C71, Pin/O-Ring=A71/B71

*2 Pin/O-Ring=A72/B72



1-1/2"

Impact Sockets
Impact Steckschlüssel
Douilles Impact

17405M (mm)	D ₁ (mm)	D ₂ (mm)	H (mm)	L (mm)	(g)	(pce.)	⚡
46	74	86	26	84	2360	1	*1
50	79	86	27	84	2400	1	*1
55	85	86	44	90	2450	1	*1
60	91	86	43	90	2640	1	*1
65	97	86	48	95	3050	1	*1
70	103	86	52	100	3350	1	*1
75	108	86	56	105	3700	1	*1
80	115	86	60	110	4240	1	*1
85	122	86	60	110	4550	1	*1
90	128	86	60	112	4840	1	*1
95	135	127	52	112	7660	1	*2
100	140	127	53	115	7700	1	*2

17405A (inch)	D ₁ (mm)	D ₂ (mm)	H (mm)	L (mm)	(g)	(pce.)	⚡
1.11/16	71	86	22	80	2300	1	*1
1. 3/4	73	86	22	80	2290	1	*1
1. 7/8	77	86	26	84	2440	1	*1
1.15/16	79	86	27	84	2400	1	*1
2	80	86	27	84	2420	1	*1
2. 1/16	82	86	38	84	2340	1	*1
2. 1/8	84	86	38	84	2340	1	*1
2. 3/16	85	86	44	90	2450	1	*1
2. 1/4	87	86	43	90	2460	1	*1
2. 3/8	91	86	43	90	2640	1	*1
2. 7/16	93	86	47	95	2860	1	*1
2. 1/2	96	86	47	95	3000	1	*1
2. 9/16	97	86	48	95	3050	1	*1
2. 5/8	100	86	51	100	3300	1	*1
2.13/16	105	86	55	105	3400	1	*1
2.15/16	108	86	56	105	3700	1	*1

*1 C-Ring=C71, Pin/O-Ring=A71/B71
*2 Pin/O-Ring=A72/B72

➔ P268-269

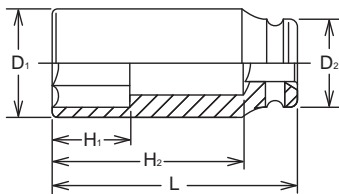

17405M / 17405A

12-point Sockets
12-kant Steckschlüssel
Douilles 12-pans

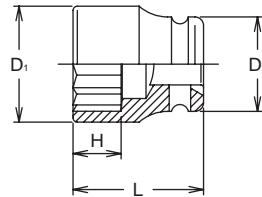

17300M / 17300A

6-point Deep Sockets
6-kant-Steckschlüssel,lang
Douilles longues 6-pans



17300M (mm)	D ₁ (mm)	D ₂ (mm)	H ₁ (mm)	H ₂ (mm)	L (mm)	(g)	(pce.)	⚡
36	63	86	26	70.5	115	2800	1	*1
41	68	86	27	70.5	115	3080	1	*1
42	70	86	27	70.5	115	3140	1	*1
46	74	86	28	80.5	125	3440	1	*1
50	79	86	30	90.5	135	3840	1	*1
54	84	86	30	90.5	135	4160	1	*1
55	85	86	33	90.5	135	4130	1	*1
60	91	86	35	90.5	135	4370	1	*1
65	97	86	38	99.5	145	5260	1	*1
70	103	86	40	98.5	145	5780	1	*1
75	108	86	42	107.5	155	6580	1	*1
80	115	86	46	115.5	165	7740	1	*1
85	122	86	49	114.5	165	7420	1	*1
90	128	86	52	122.5	175	9630	1	*1
95	135	127	55	121.5	175	10450	1	*2
100	140	127	58	130.5	185	9741	1	*2
105	146	127	62	138.5	195	10850	1	*2
110	153	127	65	137.5	195	11500	1	*2
115	160	127	68	135.5	195	12160	1	*2
120	166	127	72	144.5	205	13680	1	*2
125	173	127	74	142.5	205	14450	1	*2
130	180	127	76	142.5	205	15190	1	*2

*1 C-Ring=C71, Pin/O-Ring=A71/B71
*2 Pin/O-Ring=A72/B72

➔ P268-269

17300A (inch)	D ₁ (mm)	D ₂ (mm)	H ₁ (mm)	H ₂ (mm)	L (mm)	(g)	(pce.)	⚡
1. 5/8	68	86	27	70.5	115	3080	1	*1
1.11/16	71	86	27	70.5	115	3180	1	*1
1. 3/4	73	86	27	70.5	115	3210	1	*1
1.13/16	74	86	28	80.5	125	3440	1	*1
1. 7/8	77	86	28	80.5	125	3550	1	*1
1.15/16	79	86	28	80.5	125	3590	1	*1
2	80	86	30	90.5	135	3916	1	*1
2. 1/16	82	86	30	90.5	135	4030	1	*1
2. 1/8	84	86	30	90.5	135	4160	1	*1
2. 3/16	85	86	33	90.5	135	4200	1	*1
2. 1/4	87	86	33	90.5	135	4160	1	*1
2. 3/8	91	86	35	90.5	135	4370	1	*1
2. 7/16	93	86	35	90.5	135	4490	1	*1
2. 1/2	96	86	35	90.5	135	4630	1	*1
2. 9/16	97	86	38	99.5	145	5260	1	*1
2. 5/8	100	86	38	99.5	145	5320	1	*1
2.11/16	101	86	38	99.5	145	5670	1	*1
2. 3/4	103	86	40	98.5	145	5780	1	*1
2.13/16	105	86	40	98.5	145	6000	1	*1
2. 7/8	106	86	40	98.5	145	6080	1	*1
2.15/16	108	86	42	107.5	155	6580	1	*1
3	108	86	42	107.5	155	6850	1	*1
3. 1/8	115	86	46	115.5	165	7740	1	*1
3. 3/4	135	127	55	121.5	175	12200	1	*2
3. 7/8	140	127	56	120.5	175	11080	1	*2

Z-SERIES
HAND
TITANIUM
ACCESSORIES
SCREWDRIVERS
IMPACT
SLEEVE-DRIVE
PROTECTOR
INDUSTRIAL
AUTOMOTIVE
MOTORCYCLE
CONSTRUCTION
SPARE PART

Impact Sockets Impact Steckschlüssel Douilles Impact

1-1/2"

Z-SERIES
HAND
TITANIUM
SCREWDRIVERS
ACCESSORIES
IMPACT
SLEEVE-DRIVE
PROTECTOR
INDUSTRIAL
AUTOMOTIVE
CONSTRUCTION
MOTORCYCLE
SPARE PART

17108-32

Bit Holder complete with Bit
Klingenhalter, komplett mit Klinge
Porte embouts avec bit

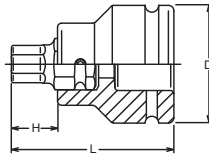

17108-32 (mm)	D (mm)	H (mm)	L (mm)	(g)	(pce.)	
19	86	30	115	2500	1	*1
22	86	30	115	2520	1	*1
24	86	30	115	2530	1	*1
27	86	30	115	2560	1	*1
30	86	30	115	2590	1	*1
32	86	30	115	2610	1	*1
36	86	30	115	2660	1	*1

*1 C-Ring=C71, Pin/O-Ring=A71/B71 → P268-269

The items with ⚠ have larger output sizes than 32mm Input drive.
Due to this design the maximum output torque rating is less than standard.

Die mit ⚠ gekennzeichneten Artikel haben größere Abtriebsgrößen als der 32mm Antrieb.
Aufgrund dieser Konstruktion ist das maximale Abtriebsdrehmoment geringer als der Standardwert.

Les articles marqués d'un ⚠ ont des tailles de sortie plus importantes que l'entraînement d'entrée 32mm.

En raison de cette conception, le couple de sortie maximum est inférieur au couple standard.

17108

Bit Holder
Klingenhalter
Porte-embouts

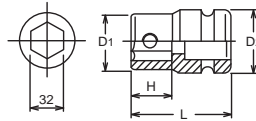

	D ₁ (mm)	D ₂ (mm)	H (mm)	L (mm)	(g)	(pce.)	
17108	60	86	30	85	2200	1	*1

*1 C-Ring=C71, Pin/O-Ring=A71/B71 → P268-269

16107-SC

Replacement Screw : M8x14, ● 4mm
Ersatzschraube : M8x14, ● 4mm
Vis de remplacement : M8x14, ● 4mm

107-32

Bit for Inhex Screws
Klingen für Innsechskant-Schrauben
Embouts pour vis 6-pans mâle creux

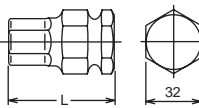

107-32 (mm)	L (mm)	(g)	(pcs.)
19	60	300	10
22	60	320	10
24	60	330	10
27	60	360	10
30	60	390	10
32	60	410	10
36	60	460	10



1-1/2"

Impact Sockets
Impact Steckschlüssel
Douilles Impact

	D (mm)	L (mm)	(g)	(pce.)	⚡
17760-175	86	175	3300	1	*1
17760-250	86	250	4500	1	*1
17760-330	86	330	5200	1	*1

*1 C-Ring=C71, Pin/O-Ring=A71/B71 → P268-269

17760 Extension Bars
Verlängerungen
Rallonges

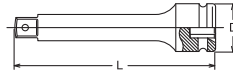

	L (mm)	(g)	(pce.)	⚡
17770	200	4700	1	*1

*1 C-Ring=C71, Pin/O-Ring=A71/B71 → P268-269

17770 Universal Joint
Gelenk-Einsatz
Joint articulé

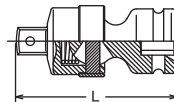

	(sq.)	(sq.)	L (mm)	(g)	(pce.)	⚡
17788A	1.1/2"	1"	98	2600	1	*1

*1 C-Ring=C71, Pin/O-Ring=A71/B71 → P268-269

⚠ Adapting down from bigger square drive to smaller square drive may lead to excessive torque load and possibly cause breakage. Always stay within safe torque of the smaller square drive.

Die mit **⚠** gekennzeichneten Artikel können bei Überbelastung zu Bruch gehen. Aus Gründen Ihrer eigenen Sicherheit sollten die betreffenden Werkzeuge nie ruckartig, sondern nach und nach belastet werden, um Bruch und damit verbundene mögliche Verletzungen zu vermeiden.

Il est possible d'appliquer aux articles marqués **⚠** des couples de serrage susceptibles d'occasionner leur rupture. Pour votre propre sécurité, veuillez toujours appliquer la charge d'une manière uniforme et progressive. Ceci pour éviter ruptures et accidents.

17788A **⚠** Adaptor
Verbindungsstück
Réducteur

No Warranty
Keine Garantie
Sans Garantie

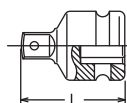

	(sq.)	(sq.)	L (mm)	(g)	(pce.)	⚡
17799A	1.1/2"	2.1/2"	115	3790	1	*1

*1 C-Ring=C71, Pin/O-Ring=A71/B71 → P268-269

17799A Adaptor
Verbindungsstück
Augmentateur

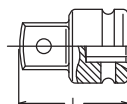

Z-SERIES
HAND
TITANIUM
ACCESSORIES
SCREWDRIVERS
IMPACT
SLEEVE-DRIVE
PROTECTOR
INDUSTRIAL
AUTOMOTIVE
MOTORCYCLE
CONSTRUCTION
SPARE PART

19400M / 19400A

6-point Sockets
6-kant Steckschlüssel
Douilles 6-pans

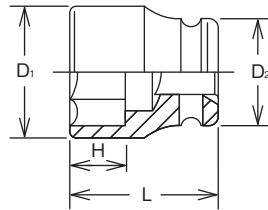

19400M (mm)	D ₁ (mm)	D ₂ (mm)	H (mm)	L (mm)	(g)	(pce.)	
50	88	127	39	115	6550	1	*1
55	94	127	42	115	6720	1	*1
60	100	127	45	125	7430	1	*1
65	105	127	48	125	7350	1	*1
70	110	127	51	125	7260	1	*1
75	118	127	54	125	7170	1	*1
80	124	127	57	125	6960	1	*1
85	127	127	61	132	7320	1	*1
90	135	127	64	132	7950	1	*1
95	140	127	71	140	8660	1	*1
100	146	127	71	142	9230	1	*1
105	155	127	74	146	11600	1	*1
110	160	127	76	155	11600	1	*1
115	167	127	78	158	12600	1	*1
120	175	175	79	160	18500	1	*2
125	180	175	82	165	19400	1	*2
130	185	175	85	169	20600	1	*2
135	190	175	89	175	21800	1	*2
140	200	175	93	180	24000	1	*2
145	205	175	95	183	25300	1	*2
150	210	175	97	192	27600	1	*2
160	225	175	102	200	31700	1	*2
165	230	175	105	204	33100	1	*2
170	235	175	106	207	34100	1	*2
175	240	175	109	211	35600	1	*2
180	250	175	110	214	40300	1	*2
185	255	175	113	218	40300	1	*2
190	265	175	113	220	46400	1	*2
200	275	175	116	225	46400	1	*2
210	285	175	123	235	50200	1	*2
215	290	175	126	240	51000	1	*2
225	305	175	133	250	55700	1	*2
235	315	175	140	260	59600	1	*2

19400A (inch)	D ₁ (mm)	D ₂ (mm)	H (mm)	L (mm)	(g)	(pce.)	
2. 1/8	92	127	41	115	6670	1	*1
2. 3/8	100	127	45	125	7430	1	*1
2. 7/16	102	127	46	125	7440	1	*1
2. 1/2	103	127	47	125	7280	1	*1
2. 9/16	105	127	48	125	7350	1	*1
2. 5/8	107	127	49	125	7260	1	*1
2.11/16	108	127	50	125	7260	1	*1
2. 3/4	110	127	51	125	7260	1	*1
2.13/16	113	127	52	125	7170	1	*1
2. 7/8	115	127	53	125	7170	1	*1
2.15/16	118	127	54	125	7260	1	*1
3	120	127	55	125	7250	1	*1
3. 1/8	124	127	57	125	6960	1	*1
3. 1/4	125	127	59	125	6970	1	*1
3. 3/8	127	127	61	132	7320	1	*1
3. 1/2	135	127	64	132	7950	1	*1
3. 5/8	138	127	64	132	8180	1	*1
3. 3/4	140	127	71	140	8660	1	*1
3. 7/8	143	127	70	140	8730	1	*1
4	146	127	71	142	9230	1	*1
4. 1/8	155	127	70	142	11600	1	*1
4. 1/4	160	127	76	155	11600	1	*1
4. 3/8	163	127	76	155	12600	1	*1
4. 1/2	167	127	78	158	12600	1	*1
4. 5/8	175	175	79	160	18500	1	*2
4. 7/8	180	175	82	165	19400	1	*2
5	183	175	81	165	20100	1	*2
5. 1/4	190	175	89	175	21800	1	*2
5. 3/8	198	175	94	180	24200	1	*2
5. 1/2	200	175	93	180	24000	1	*2
5. 5/8	203	175	94	182	25300	1	*2
5. 3/4	207	175	103	192	26600	1	*2
6	217	175	100	196	31700	1	*2
6. 1/8	218	175	99	196	31700	1	*2
6. 5/8	233	175	105	205	34100	1	*2
7	248	175	110	213	40300	1	*2

*1 Pin/O-Ring=A91/B91
*2 Pin/O-Ring=A92/B92



2-1/2" Impact Sockets Impact Steckschlüssel Douilles Impact

Z-SERIES
HAND
TITANIUM
ACCESSORIES
SCREWDRIVERS
IMPACT
SLEEVE-DRIVE
PROTECTOR
INDUSTRIAL
AUTOMOTIVE
MOTORCYCLE
CONSTRUCTION
SPARE PART

19300M (mm)	D ₁ (mm)	D ₂ (mm)	H ₁ (mm)	H ₂ (mm)	L (mm)	(g)	(pce.)	⚡
75	118	127	42	129	190	11600	1	*1
80	124	127	46	129	190	11800	1	*1
85	127	127	49	134	195	12000	1	*1
90	135	127	52	144	205	13800	1	*1
95	140	127	55	149	210	14100	1	*1
100	146	127	58	154	215	15700	1	*1
105	155	127	62	146.5	220	18000	1	*1
110	160	127	65	150.5	225	18900	1	*1
115	167	127	68	153.5	230	20700	1	*1
120	175	175	72	157.5	235	28000	1	*2
125	180	175	74	158.5	238	29100	1	*2
130	185	175	76	163.5	243	31000	1	*2
135	190	175	80	165.5	248	32100	1	*2
140	200	175	82	164.5	248	34700	1	*2
145	205	175	84	163.5	248	35900	1	*2
150	210	175	88	168.5	255	37200	1	*2
155	215	175	92	167.5	255	38200	1	*2
160	225	175	95	170.5	260	42000	1	*2
165	230	175	98	169.5	260	42700	1	*2
170	235	175	100	172.5	265	44400	1	*2
175	240	175	102	176.5	270	46100	1	*2

*1 Pin/O-Ring=A91/B91 → P269
*2 Pin/O-Ring=A92/B92

	D (mm)	L (mm)	(g)	(pce.)	⚡
19760-250	127	250	17800	1	*1
19760-500	127	500	27800	1	*1

*1 Pin/O-Ring=A91/B91 → P269

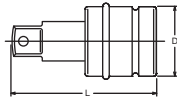

	L (mm)	(g)	(pce.)	⚡
19770	303	21360	1	*1

*1 Pin/O-Ring=A91/B91 → P269

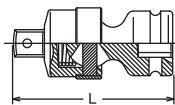

	(sq.)	(sq.)	L (mm)	(g)	(pce.)	⚡
19977A	2.1/2"	1.1/2"	145	7210	1	*1

*1 Pin/O-Ring=A91/B91 → P269

⚠ Adapting down from bigger square drive to smaller square drive may lead to excessive torque load and possibly cause breakage. Always stay within safe torque of the smaller square drive.

Die mit ⚠ gekennzeichneten Artikel können bei Überbelastung zu Bruch gehen. Aus Gründen Ihrer eigenen Sicherheit sollten die betreffenden Werkzeuge nie ruckartig, sondern nach und nach belastet werden, um Bruch und damit verbundene mögliche Verletzungen zu vermeiden.

Il est possible d'appliquer aux articles marqués ⚠ des couples de serrage susceptibles d'occasionner leur rupture. Pour votre propre sécurité, veuillez toujours appliquer la charge d'une manière uniforme et progressive. Ceci pour éviter ruptures et accidents.

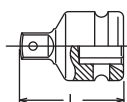

19300M 6-point Deep Sockets 6-kant-Steckschlüssel, lang Douilles longues 6-pans

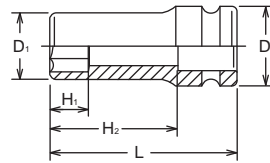

19760 Extension Bars Verlängerungen Rallonges



19770 Universal Joint Gelenk-Einsatz Joint articulé



19977A Adaptor Verbindungsstück Réducteur

No Warranty
Keine Garantie
Sans Garantie ⚠



Z-SERIES
HAND
TITANIUM
ACCESSORIES
IMPACT
SLEEVE-DRIVE
PROTECTOR
INDUSTRIAL
AUTOMOTIVE
MOTORCYCLE
CONSTRUCTION
SPARE PART

10400M / 10400A

6-point Sockets
6-kant Steckschlüssel
Douilles 6-pans

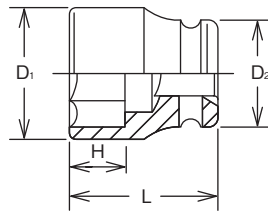

10400M (mm)	D ₁ (mm)	D ₂ (mm)	H (mm)	L (mm)	(g)	(pce.)	
105	165	175	86	176	19370	1	*1
110	170	175	88	179	20160	1	*1
115	175	175	90	183	21160	1	*1
120	180	175	91	185	21930	1	*1
125	188	175	94	190	23940	1	*1
130	193	175	97	194	25050	1	*1
135	200	175	101	199	26930	1	*1
140	205	175	105	205	28560	1	*1
145	210	200	106	207	29600	1	*2
150	215	200	109	212	31240	1	*2
160	228	200	114	220	35500	1	*2
165	235	200	117	224	37940	1	*2
170	240	200	118	227	39660	1	*2
175	245	200	121	231	41400	1	*2
180	255	200	122	234	45740	1	*2
185	265	200	125	238	50350	1	*2
190	275	200	125	239	54650	1	*2
200	285	200	128	245	59190	1	*2
210	295	200	135	255	64970	1	*2
215	300	200	138	260	68150	1	*2

10400A (inch)	D ₁ (mm)	D ₂ (mm)	H (mm)	L (mm)	(g)	(pce.)	
4.1/8	165	175	86	176	19370	1	*1
4.1/4	168	175	87	178	19770	1	*1
4.3/8	172	175	88	180	20660	1	*1
4.1/2	175	175	89	182	21160	1	*1
4.5/8	178	175	90	183	21550	1	*1
4.3/4	180	175	91	185	21930	1	*1
4.7/8	188	175	94	190	23940	1	*1
5	188	175	95	191	24500	1	*1
5.1/8	193	175	97	194	25050	1	*1
5.1/4	197	175	100	198	25990	1	*1
5.3/8	201	175	102	202	27750	1	*1
5.1/2	205	175	105	205	28560	1	*1
5.5/8	208	200	106	208	30110	1	*2
5.3/4	212	200	108	210	30610	1	*2
5.7/8	215	200	109	212	31240	1	*2
6	219	200	110	214	32460	1	*2
6.1/8	223	200	112	216	33670	1	*2
6.1/4	227	200	114	218	34590	1	*2
6.3/8	231	200	115	221	36720	1	*2
6.1/2	235	200	117	224	37940	1	*2
6.5/8	238	200	118	226	38800	1	*2
6.3/4	241	200	119	228	39870	1	*2
6.7/8	245	200	120	230	40640	1	*2
7	251	200	121	232	43570	1	*2
7.1/8	257	200	122	234	46450	1	*2
7.1/4	263	200	123	236	48400	1	*2
7.3/8	269	200	124	238	52500	1	*2
7.1/2	275	200	125	240	55350	1	*2
7.5/8	278	200	127	242	56050	1	*2
7.3/4	282	200	129	245	57620	1	*2
7.7/8	285	200	130	248	60870	1	*2
8	290	200	132	250	62550	1	*2
8.1/8	293	200	133	251	63760	1	*2
8.1/4	295	200	135	255	64970	1	*2
8.3/8	298	200	136	258	65580	1	*2
8.1/2	300	200	138	260	68150	1	*2
8.5/8	305	200	139	262	70760	1	*2
8.3/4	310	200	140	264	73830	1	*2
8.7/8	313	200	142	267	75780	1	*2

*1 Pin/O-Ring=A01/B01 → P269
*2 Pin/O-Ring=A02/B02

10099A

Adaptor
Verbindungsstück
Réducteur

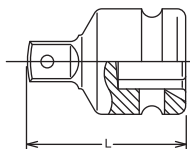

	(sq.)	(sq.)	L (mm)	(g)	(pce.)	
10099A	3.1/2"	2.1/2"	182	16870	1	*1

*1 Pin/O-Ring=A01/B01 → P269

⚠ Adapting down from bigger square drive to smaller square drive may lead to excessive torque load and possibly cause breakage. Always stay within safe torque of the smaller square drive.

Die mit ⚠ gekennzeichneten Artikel können bei Überbelastung zu Bruch gehen. Aus Gründen Ihrer eigenen Sicherheit sollten die betreffenden Werkzeuge nie ruckartig, sondern nach und nach belastet werden, um Bruch und damit verbundene mögliche Verletzungen zu vermeiden.

Il est possible d'appliquer aux articles marqués ⚠ des couples de serrage susceptibles d'occasionner leur rupture. Pour votre propre sécurité, veuillez toujours appliquer la charge d'une manière uniforme et progressive. Ceci pour éviter ruptures et accidents.

SLEEVE-DRIVE SOCKETS

SLEEVE-DRIVE STECKSCHLÜSSEL

DOUILLES, SLEEVE DRIVE

3/8"

1/2"

3/4"



Sleeve-Drive Sockets
 Sleeve-Drive Steckschlüssel
 Douilles, Sleeve Drive

Z-SERIES
 HAND
 TITANIUM
 ACCESSORIES
 SCREWDRIVERS
 IMPACT
 SLEEVE-DRIVE
 PROTECTOR
 INDUSTRIAL
 AUTOMOTIVE
 MOTORCYCLE
 CONSTRUCTION
 SPARE PART



The deepened drive end of the **Sleeve-Drive** tools prevents the sometimes "wobbly" connection between pulse tool - extension - socket. An O-ring inside **Sleeve-Drive** optimizes the perfect fit of extension bars and sockets on the anvil to the effect, that the exactness of the required torque given by the pulse tool is generally improved. Further, the **Sleeve-Drive** avoids the direct transmission of vibrations on the pulse tool and finally on the operator.

Der **Sleeve-Drive** Vierkant-Antrieb vermeidet durch die vertiefte Passung den "Wackelkontakt" zwischen Maschine - Verlängerung - Steckschlüssel. Ein im **Antriebsende der Sleeve-Drive-Steckschlüssel** eingesetzter Ring optimiert den festen Sitz der Verlängerungen und Steckschlüssel auf der Schrauberspindel und sorgt somit für die unmittelbare Weitergabe des vorgegebenen Drehmomentes ohne wesentliche Drehkraftverluste. Nicht zuletzt vermeidet der **Sleeve-Drive** Antrieb die Übertragung von Schwingungen auf Mensch und Maschine.

Ces nouveaux outils **Sleeve-Drive** se caractérisent par un entraînement carré allongé et un joint torique incorporé. Le guidage rigide ainsi obtenu maintient les outils **Sleeve-Drive** dans l'axe de la broche de la machine et garantit une connection optimale machine-rallonges-douilles. Le jeu latéral et les vibrations engendrés par les outils traditionnels sont de ce fait supprimés. Il en résulte une transmission plus précise du coupe de serrage et un plus grand confort de travail pour l'opérateur.

Sleeve Drive Sockets

Wrenches

O-Ring

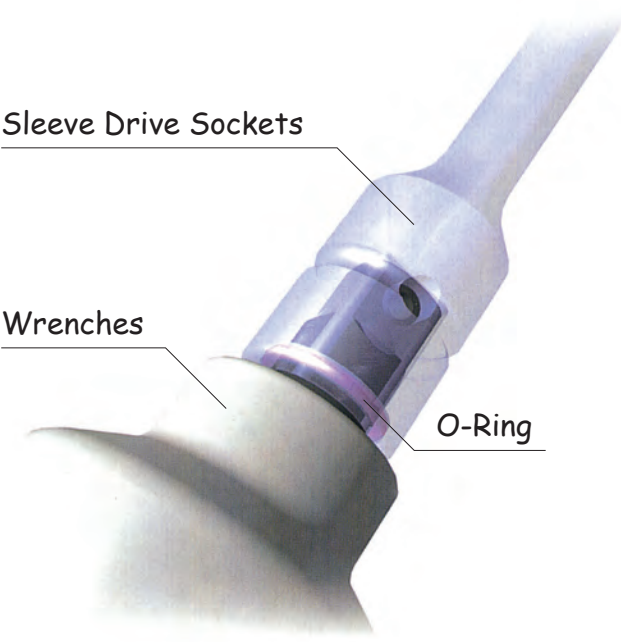

SLEEVE DRIVE SOCKET PULSE TOOL

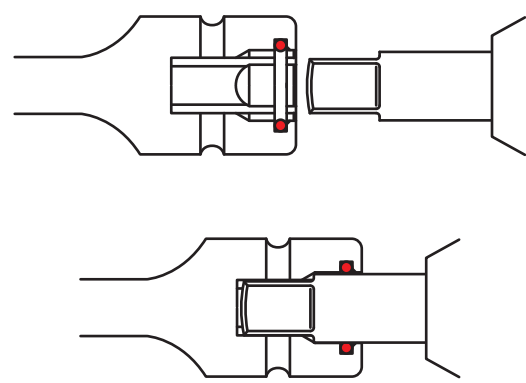

The "**Sleeve Drive**" Sockets and accessories are designed for use on Pulse Tools with anvils of certain lengths and diameters as shown hereunder.

Die serienmässigen "**Sleeve Drive**" Steckschlüssel können nur auf Impuls Schraubern mit Antriebswellen der nachstehenden Längen und Durchmesser gesteckt werden.

Les douilles "**Sleeve Drive**" ne peuvent être placées que sur des axes des boulonneuses à impulsions d'une longueur et d'un diamètre selon la spécification ci-dessous.

	Anvil Diameter (mm)	Minimum Anvil Length (mm)
3/8"sq.	12	10
1/2"sq.	16	10
3/4"sq.	25	11.8

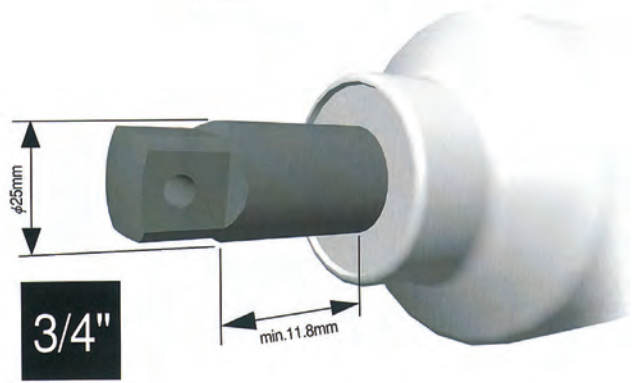
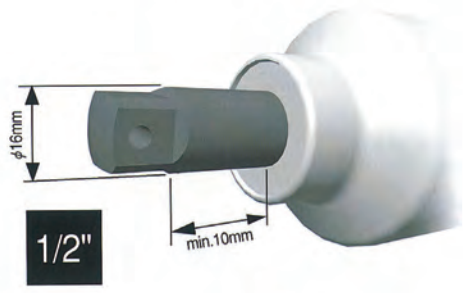
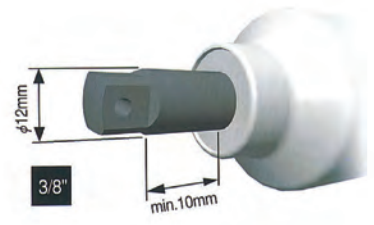

3/8"

Sleeve-Drive Sockets
Sleeve-Drive Steckschlüssel
Douilles, Sleeve Drive

NV13400 (mm)	D ₁ (mm)	D ₂ (mm)	H (mm)	L (mm)	(g)	(pcs.)	
8	13.3	19	6	43	53	10	*1
10	15.8	19	7	43	53	10	*1
11	17	19	8	43	54	10	*1
12	18.3	19	9	43	55	10	*1
13	19.5	22	10	43	80	10	*2
14	20.8	22	10	43	80	10	*2
15	22	22	11	43	81	10	*2
16	23.3	22	11	43	83	10	*2
17	24.5	22	11	43	85	10	*2
18	25.8	22	11	43	89	10	*2
19	27	22	11	43	98	10	*2
21	29.5	22	11	43	105	10	*2
22	30.8	22	11	43	112	10	*2

*1 C-Ring=C31, Pin/O-Ring=A31/B31
*2 C-Ring=C32, Pin/O-Ring=A32/B32
→ P268-269

NV13400



6-point Sockets
6-kant Steckschlüssel
Douilles 6-pans

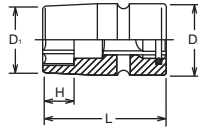

NV13145-100 (mm)	D ₁ (mm)	D ₂ (mm)	H (mm)	L (mm)	(g)	(pcs.)	
6	13	19	6	100	108	5	*1
8	13	19	8	100	110	5	*1
10	15.5	19	10	100	112	5	*1
12	18	19	12	100	120	5	*1
13	19	19	13	100	127	5	*1
14	21	19	14	100	131	5	*1
15	22	19	15	100	133	5	*1
16	24	19	15	100	144	5	*1
17	25	19	15	100	154	5	*1

NV13145-150 (mm)	D ₁ (mm)	D ₂ (mm)	H (mm)	L (mm)	(g)	(pcs.)	
6	13	19	6	150	160	5	*1
8	13	19	8	150	160	5	*1
10	15.5	19	10	150	165	5	*1
12	18	19	12	150	168	5	*1
13	19	19	13	150	170	5	*1
14	21	19	14	150	175	5	*1
15	22	19	15	150	177	5	*1
16	24	19	15	150	190	5	*1
17	25	19	15	150	203	5	*1

NV13145-200 (mm)	D ₁ (mm)	D ₂ (mm)	H (mm)	L (mm)	(g)	(pcs.)	
6	13	19	6	200	210	5	*1
8	13	19	8	200	210	5	*1
10	15.5	19	10	200	212	5	*1
12	18	19	12	200	214	5	*1
13	19	19	13	200	218	5	*1
14	21	19	14	200	220	5	*1
15	22	19	15	200	226	5	*1
16	24	19	15	200	235	5	*1
17	25	19	15	200	250	5	*1

*1 C-Ring=C31, Pin/O-Ring=A31/B31
→ P268-269

NV13145-100 / -150 / -200



Extended Sockets
Schaftsteckschlüssel
Douilles rallongées

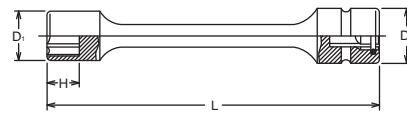

	D (mm)	L (mm)	(g)	(pcs.)	
NV13760-75P	19	75	95	10	*1
NV13760-125P	19	125	125	5	*1
NV13760-150P	19	150	150	5	*1
NV13760-250P	19	250	255	5	*1

*1 C-Ring=C31, Pin/O-Ring=A31/B31
→ P268-269

NV13760-P

Extension Bars
Verlängerungen
Rallonges

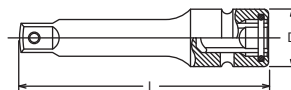

Z-SERIES
HAND
TITANIUM
ACCESSORIES
SCREWDRIVERS
IMPACT
SLEEVE-DRIVE
PROTECTOR
INDUSTRIAL
AUTOMOTIVE
MOTORCYCLE
CONSTRUCTION
SPARE PART

Z-SERIES
HAND
TITANIUM
SCREWDRIVERS ACCESSORIES
IMPACT
SLEEVE-DRIVE
PROTECTOR
INDUSTRIAL
AUTOMOTIVE
MOTORCYCLE
CONSTRUCTION
SPARE PART

183H-35 / -75 / -150

Hex Bits
Sechskant Bits
Embouts, 6 pans creux

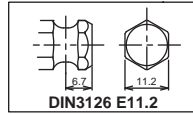
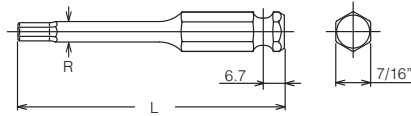

183H-35 (mm)	L (mm)	(g)	(pcs.)
3	35	15	10
4	35	15	10
5	35	15	10
6	35	18	10
7	35	19	10
8	35	20	10
9	35	23	10
10	35	26	10
11	35	28	10
12	35	30	10
14	35	35	10
16	35	47	10
17	35	50	10
18	35	53	10
19	35	56	10

183H-35 (inch)	L (mm)	(g)	(pcs.)
3/16	35	15	10
7/32	35	16	10
1/4	35	18	10
5/16	35	20	10
3/8	35	26	10
7/16	35	28	10
1/2	35	38	10

183H-75 (mm)	L (mm)	R (mm)	(g)	(pcs.)
3	75	6	34	10
4	75	6	35	10
5	75	6.5	36	10
6	75	7.5	39	10
7	75	8.5	44	10
8	75	9.5	47	10
10	75	-	57	10
11	75	-	60	10
12	75	-	65	10
14	75	-	79	10

183H-150 (mm)	L (mm)	R (mm)	(g)	(pcs.)
4	150	6	51	10
5	150	6.5	55	10
6	150	7.5	65	10
8	150	9.5	87	10
10	150	-	118	10
12	150	-	136	10

183H-75B / -150B

Ball-point Hex Bits
Sechskant Bits mit Kugelkopf
Embouts hexagonaux à tête sphérique

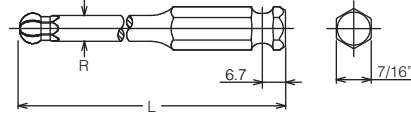

183H-75B (mm)	L (mm)	R (mm)	(g)	(pcs.)
6B	75	5.7	39	10
8B	75	7.7	44	10
10B	75	9.7	49	10
12B	75	11.7	72	10

183H-150B (mm)	L (mm)	R (mm)	(g)	(pcs.)
6B	150	5.7	65	10
8B	150	7.7	71	10
10B	150	9.7	92	10
12B	150	11.7	135	10

183T-35 / -75 / -150 (T)

TORX® Bits
TORX® Bits
Embouts, TORX®

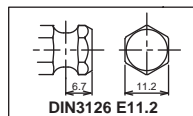
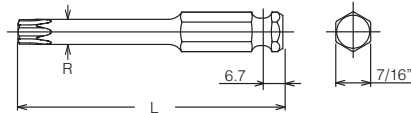

183T-35 (T)	L (mm)	(g)	(pcs.)
T25	35	18	10
T30	35	18	10
T40	35	20	10
T45	35	22	10
T50	35	26	10
T55	35	30	10
T60	35	38	10

183T-75 (T)	L (mm)	R (mm)	(g)	(pcs.)
T25	75	6	33	10
T27	75	6	33	10
T30	75	6	35	10
T40	75	6.9	37	10
T45	75	8	41	10
T50	75	9	45	10
T55	75	11.4	55	10
T60	75	13.5	67	10

183T-150 (T)	L (mm)	R (mm)	(g)	(pcs.)
T30	150	6	50	10
T40	150	6.9	58	10
T45	150	8	70	10
T50	150	9	82	10
T55	150	11.4	113	10
T60	150	13.5	148	10

⚠ The items with ⚠ have larger output sizes than 7/16" input drive. Due to this design the maximum output torque rating is less than standard.

Die mit ⚠ gekennzeichneten Artikel haben größere Abtriebsgrößen als der 7/16" Antrieb. Aufgrund dieser Konstruktion ist das maximale Abtriebsdrehmoment geringer als der Standardwert.

Les articles marqués d'un ⚠ ont des tailles de sortie plus importantes que l'entraînement d'entrée 7/16". En raison de cette conception, le couple de sortie maximum est inférieur au couple standard.

TORX® is a registered trademark of CAMCAR Innovations.
TORX® ist ein registriertes Markenzeichen der Firma CAMCAR Innovations.
TORX® est une marque déposée de CAMCAR Innovations.

3/8", 1/2"

Sleeve-Drive Sockets
Sleeve-Drive Steckschlüssel
Douilles, Sleeve Drive

183T-35 (IP)	L (mm)	(g)	(pcs.)
30IP	35	18	10
40IP	35	20	10
45IP	35	22	10
50IP	35	26	10
55IP	35	30	10
60IP	35	38	10

183T-75 (IP)	L (mm)	R (mm)	(g)	(pcs.)
30IP	75	6	35	10
40IP	75	6.8	37	10
45IP	75	8	41	10
50IP	75	9	45	10
55IP	75	11.4	56	10
60IP	75	13.5	67	10

183T-35 / -75 (IP)

TORXPLUS® Bits
TORXPLUS® Bits
Embouts TORXPLUS®

TORXplus

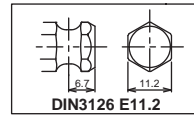
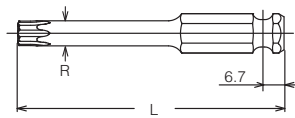

DIN3126 E11.2



183X-35 (XZN)	L (mm)	(g)	(pcs.)
M 4	35	18	10
M 5	35	18	10
M 6	35	20	10
M 8	35	22	10
M10	35	26	10
M12	35	30	10
M14	35	38	10

183X-75 (XZN)	L (mm)	R (mm)	(g)	(pcs.)
M 4	75	6	34	10
M 5	75	6	34	10
M 6	75	6.2	36	10
M 8	75	7.4	39	10
M10	75	9.8	54	10
M12	75	11.7	57	10
M14	75	13.5	67	10

183X-150 (XZN)	L (mm)	R (mm)	(g)	(pcs.)
M 5	150	6	50	10
M 6	150	6.2	53	10
M 8	150	7.4	64	10
M10	150	9.8	93	10
M12	150	11.7	121	10
M14	150	13.5	151	10

183X-35 / -75 / -150 (XZN)

XZN Bits
XZN Bits
Embouts, XZN

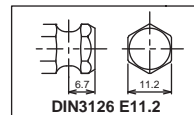
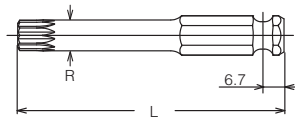

DIN3126 E11.2



The items with have larger output sizes than 7/16" Input drive. Due to this design the maximum output torque rating is less than standard.

Die mit gekennzeichneten Artikel haben größere Abtriebsgrößen als der 7/16" Antrieb. Aufgrund dieser Konstruktion ist das maximale Abtriebsdrehmoment geringer als der Standardwert.

Les articles marqués d'un ont des tailles de sortie plus importantes que l'entraînement d'entrée 7/16". En raison de cette conception, le couple de sortie maximum est inférieur au couple standard.

	D ₁ (mm)	D ₂ (mm)	H (mm)	L (mm)	(g)	(pcs.)	
NV13134	24	22	15	45	100	5	*1

*1 C-Ring=C31, Pin/O-Ring=A31/B31 → P268-269

For DIN3126 E11.2 Bits
Für DIN3126 E11.2 Bits
Pour DIN3126 E11.2 Embouts

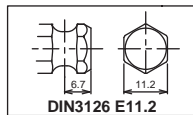

F11.2

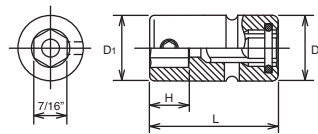

16134-SC

Replacement Screw : M8x6 ● 4mm

	D ₁ (mm)	D ₂ (mm)	H (mm)	L (mm)	(g)	(pcs.)	
NV14134	24	25	15	55	130	5	*1

*1 C-Ring=C41, Pin/O-Ring=A41/B41 → P268-269

For DIN3126 E11.2 Bits
Für DIN3126 E11.2 Bits
Pour DIN3126 E11.2 Embouts

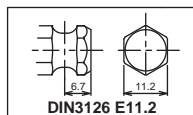

F11.2

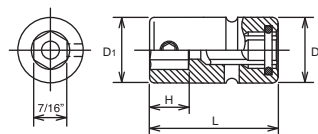

16134-SC

Replacement Screw : M8x6 ● 4mm

TORXplus is a registered trademark of CAMCAR Innovations.
TORXplus ist ein registriertes Markenzeichen der Firma CAMCAR Innovations.
TORXplus est une marque déposée de CAMCAR Innovations.

Sleeve-Drive Sockets

Sleeve-Drive Steckschlüssel

Douilles, Sleeve Drive

1/2"

Z-SERIES
HAND
TITANIUM
SCREWDRIVERS ACCESSORIES
IMPACT
SLEEVE-DRIVE
PROTECTOR
INDUSTRIAL
AUTOMOTIVE
MOTORCYCLE
CONSTRUCTION
SPARE PART

NV14400

6-point Sockets
6-kant Steckschlüssel
Douilles 6-pans

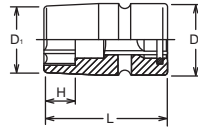

NV14400 (mm)	D ₁ (mm)	D ₂ (mm)	H (mm)	L (mm)	(g)	(pcs.)	
12	19.5	25	9	54	120	10	*1
13	20.7	25	10	54	120	10	*1
14	22	25	10	54	120	10	*1
15	23.2	30	11	54	188	10	*2
16	24.5	30	11	54	189	10	*2
17	25.7	30	12	54	190	10	*2
18	27	30	12	54	190	10	*2
19	28.2	30	12	54	190	10	*2
21	30.7	30	12	54	191	10	*2
22	32	30	12	54	192	10	*2
23	33.2	30	12	54	196	10	*2
24	34.5	30	12	54	200	10	*2

*1 C-Ring=C41, Pin/O-Ring=A41/B41 → P268-269
*2 C-Ring=C42, Pin/O-Ring=A42/B42

NV14145-100 / -150 / -200

Extended Sockets
Schaftsteckschlüssel
Douilles rallongées



NV14145-100 (mm)	D ₁ (mm)	D ₂ (mm)	H (mm)	L (mm)	(g)	(pce.)	
10	15.5	25	10	100	161	1	*1
12	18	25	12	100	178	1	*1
13	19	25	13	100	175	1	*1
14	21	25	14	100	181	1	*1
15	22	25	15	100	185	1	*1
16	24	25	15	100	193	1	*1
17	25	25	15	100	201	1	*1
18	26	25	15	100	211	1	*1
19	28	25	15	100	221	1	*1

NV14145-150 (mm)	D ₁ (mm)	D ₂ (mm)	H (mm)	L (mm)	(g)	(pce.)	
10	15.5	25	10	150	200	1	*1
12	18	25	12	150	215	1	*1
13	19	25	13	150	220	1	*1
14	21	25	14	150	225	1	*1
15	22	25	15	150	230	1	*1
16	24	25	15	150	240	1	*1
17	25	25	15	150	250	1	*1
18	26	25	15	150	262	1	*1
19	28	25	15	150	275	1	*1

NV14145-200 (mm)	D ₁ (mm)	D ₂ (mm)	H (mm)	L (mm)	(g)	(pce.)	
10	15.5	25	10	200	236	1	*1
12	18	25	12	200	250	1	*1
13	19	25	13	200	260	1	*1
14	21	25	14	200	270	1	*1
15	22	25	15	200	275	1	*1
16	24	25	15	200	287	1	*1
17	25	25	15	200	300	1	*1
18	26	25	15	200	310	1	*1
19	28	25	15	200	320	1	*1

*1 C-Ring=C41, Pin/O-Ring=A41/B41 → P268-269

NV14760-P

Extension Bars
Verlängerungen
Rallonges

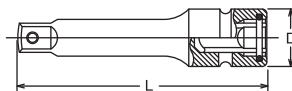

	TYPE	D (mm)	L (mm)	(g)	(pcs.)	
NV14760-75P	Pin	25	75	149	10	*1
NV14760-125P	Pin	25	125	226	5	*1
NV14760-175P	Pin	25	175	308	5	*1
NV14760-250P	Pin	25	250	422	1	*1

*1 C-Ring=C41, Pin/O-Ring=A41/B41 → P268-269

NV14433A-P

Adaptors
Verbindungsstücke
Réducteurs

No Warranty
Keine Garantie
Sans Garantie

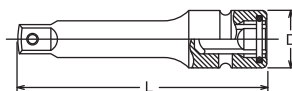

NV14433A	(mm)	(mm)	D (mm)	L (mm)	(g)	(pcs.)	
NV14433A-75P	1/2"	3/8"	25	75	120	10	*1
NV14433A-100P	1/2"	3/8"	25	100	145	10	*1
NV14433A-150P	1/2"	3/8"	25	150	187	5	*1

*1 C-Ring=C41, Pin/O-Ring=A41/B41 → P268-269

⚠ Adapting down from bigger square drive to smaller square drive may lead to excessive torque load and possibly cause breakage. Always stay within safe torque of the smaller square drive.

Die mit ⚠ gekennzeichneten Artikel können bei Überbelastung zu Bruch gehen. Aus Gründen Ihrer eigenen Sicherheit sollten die betreffenden Werkzeuge nie ruckartig, sondern nach und nach belastet werden, um Bruch und damit verbundene mögliche Verletzungen zu vermeiden.

Il est possible d'appliquer aux articles marqués ⚠ des couples de serrage susceptibles d'occasionner leur rupture. Pour votre propre sécurité, veuillez toujours appliquer la charge d'une manière uniforme et progressive. Ceci pour éviter ruptures et accidents.

3/4"

Sleeve-Drive Sockets
Sleeve-Drive Steckschlüssel
Douilles, Sleeve Drive

NV16400 (mm)	D ₁ (mm)	D ₂ (mm)	H (mm)	L (mm)	(g)	(pcs.)	
17	30	44	12	65	448	5	*1
18	31.3	44	13	65	470	5	*1
19	32.5	44	13	65	455	5	*1
21	35	44	15	65	472	5	*1
22	36.3	44	16	65	471	5	*1
23	37.5	44	16	65	471	5	*1
24	38.8	44	16	65	467	5	*1
26	41.3	44	16	65	477	5	*1
27	42.5	44	16	65	473	5	*1
28	43.8	44	16	68	483	5	*1
29	45	44	18	68	464	5	*1
30	46.3	44	18	68	492	5	*1
32	48.8	44	19	70	514	5	*1
33	50	44	20	70	564	5	*1
34	51.3	44	20	70	588	5	*1
35	52.5	44	20	70	593	5	*1
36	53.8	44	20	70	598	5	*1
38	56.3	44	20	72	670	2	*1
41	60	44	22	72	687	2	*1
46	66.3	44	23	77	906	2	*1
50	69	44	23	77	1116	2	*1

*1 C-Ring=C61, Pin/O-Ring=A61/B61 → P268-269

NV16400  6-point Sockets
6-kant Steckschlüssel
Douilles 6-pans

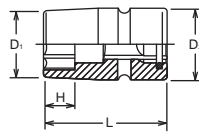

NV16760 Extension Bars
Verlängerungen
Rallonges



	D (mm)	L (mm)	(g)	(pcs.)	
NV16760-175	44	175	870	1	*1
NV16760-250	44	250	1160	1	*1
NV16760-330	44	330	1460	1	*1

*1 C-Ring=C61, Pin/O-Ring=A61/B61 → P268-269

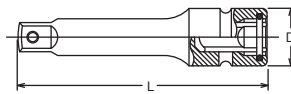

Z-SERIES
HAND
TITANIUM
ACCESSORIES
SCREWDRIVERS
IMPACT
SLEEVE-DRIVE
PROTECTOR
INDUSTRIAL
AUTOMOTIVE
MOTORCYCLE
CONSTRUCTION
SPARE PART

C-Ring Lock Clamps and Pullers
 Sicherungsklemmen und Abzieher
 Crochets de sécurité et extracteurs

Z-SERIES
 HAND
 TITANIUM
 SCREWDRIVERS ACCESSORIES
 IMPACT
 SLEEVE-DRIVE
 PROTECTOR
 INDUSTRIAL
 AUTOMOTIVE
 MOTORCYCLE
 CONSTRUCTION
 SPARE PART

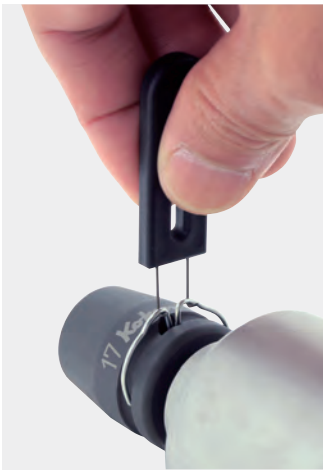

One Piece solid springs steel ring. Simply set by finger pushing and easily removed by puller. Much more convenient and safer than combination of pin and o-ring.

Aus starkem Federstahl, in einem Stück. Bequem, mit einem Fingerdruck einzusetzen und mit dem Auszieher zu lösen. Einfacher und sicherer als die Kombination Stift und Ring.

Acier à ressorts, en une pièce. Mise en place d'une simple pression du pouce, enlèvement au moyen de la griffe d'extraction. Beaucoup plus facile et sûr que la combinaison goupille/bague.

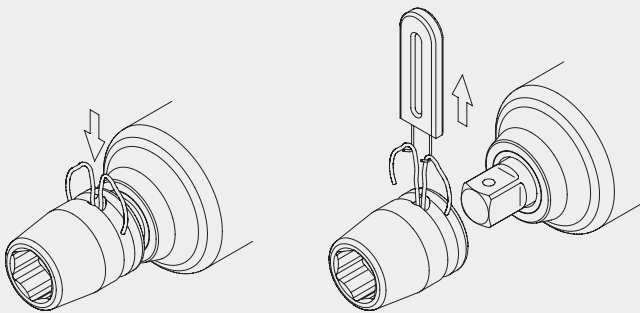

C-Ring

No.	□	Opening (mm)	pcs.
C31	3/8"	≤ 12	100
C32	3/8"	> 12	100
C41	1/2"	≤ 14	100
C42	1/2"	> 14	100
C61	3/4"	≤ 46	100
C81	1"	≤ 46	100
C82	1"	47-70	50
C83	1"	> 70	50
C71	1-1/2"	≤ 90	50

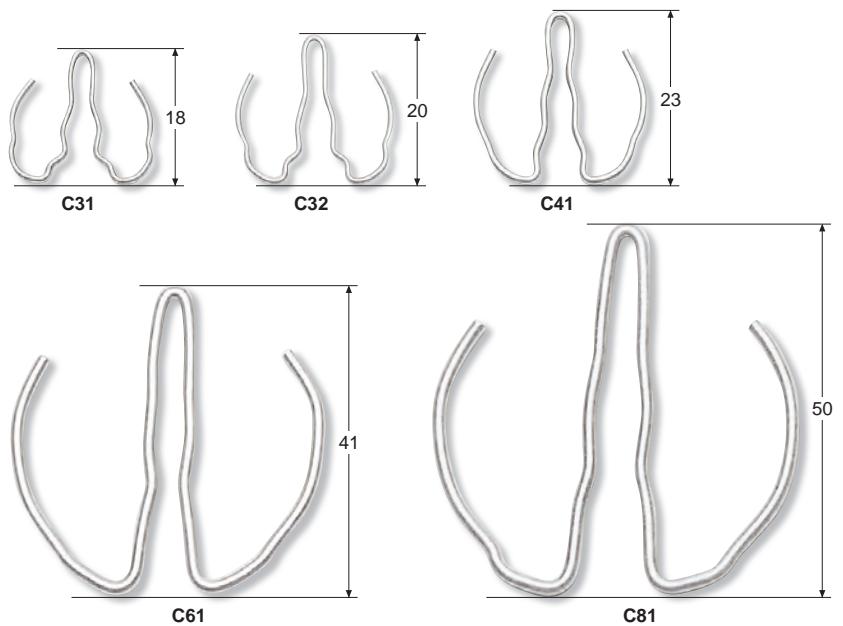

C-Ring Set

Set No.	□	C-Ring 10pcs.	Puller 1pce.
PKC31	3/8"	C31 + 149	
PKC32	3/8"	C32 + 149	
PKC41	1/2"	C41 + 149	
PKC42	1/2"	C42 + 149	
PKC61	3/4"	C61 + 152	
PKC81	1"	C81 + 152	

Puller

No.	□	□	pcs.
149	3/8"	1/2"	10
152	3/4"	1"	10



149



152

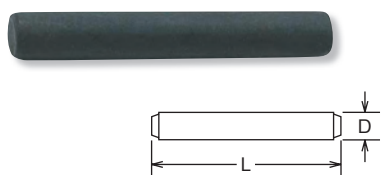

Pin

No.	Opening (mm)	D (mm)	L (mm)	(pcs.)
A21	1/4"	1.5	10.2	100
A31	3/8" ≤ 12	2.5	14.5	100
A32	3/8" > 12	2.5	17.5	100
A41	1/2" ≤ 14	3	20	100
A42	1/2" > 14	3	25	100
A51	5/8"	4	29	100
A61	3/4" ≤ 46	4	35	100
A62	3/4" > 46	4	45	100
A81	1" ≤ 46	5	45	100
A82	1" 47-70	5	57	50
A83	1" > 70	5	75	50
A71	1-1/2" ≤ 90	6	75	50
A72	1-1/2" > 90	6	110	1
A91	2-1/2" ≤ 115	8	110	1
A92	2-1/2" > 115	8	155	1
A01	3-1/2" ≤ 140	13	155	1
A02	3-1/2" > 140	13	180	1

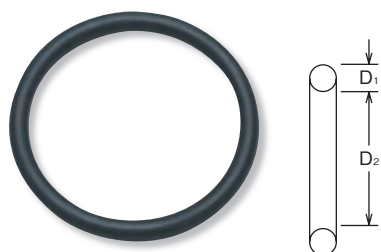

O-Ring

No.	Opening (mm)	D1 (mm)	D2 (mm)	(pcs.)
B21	1/4"	2.5	9	100
B31	3/8" ≤ 12	3.5	13	100
B32	3/8" > 12	3.5	16	100
B41	1/2" ≤ 14	4	19	100
B42	1/2" > 14	4	24	100
B51	5/8"	5	28	100
B61	3/4" ≤ 46	5	36	100
B62	3/4" > 46	5	45	100
B81	1" ≤ 46	7	45	100
B82	1" 47-70	7	57	50
B83	1" > 70	7	75	50
B71	1-1/2" ≤ 90	10	75	50
B72	1-1/2" > 90	10	114	1
B91	2-1/2" ≤ 115	10.5	114	1
B92	2-1/2" > 115	10.5	158	1
B01	3-1/2" ≤ 140	15	158	1
B02	3-1/2" > 140	15	183	1



Pins & O Rings/C-Ring Lock Clamps
 Halteringe und Stifte/Sicherungsklemmen
 Goupilles et joncs/Crochets de sécurité

Z-SERIES
 HAND
 TITANIUM
 SCREWDRIVERS ACCESSORIES
 IMPACT
 SLEEVE-DRIVE
 PROTECTOR
 INDUSTRIAL
 AUTOMOTIVE
 MOTORCYCLE
 CONSTRUCTION
 SPARE PART

IMPACT Standard Sockets size	Sq. Dr. C-Ring Pin/O-Ring	1/4"	3/8"		1/2"		3/4"		1"			1-1/2"	
			C31	C32	C41	C42	C61	C81	C81	C82	C83	C71	
		A21/B21	A31/B31	A32/B32	A41/B41	A42/B42	A61/B61	A62/B62	A81/B81	A82/B82	A83/B83	A71/B71	A72/B72
4		●											
4.5	3/16	●											
5		●											
5.5		●											
6	1/4	●	●			●							
7	9/32	●	●			●							
8	5/16	●	●			●							
9	11/32	●	●			●							
10	3/8	●	●			●							
11	7/16	●	●			●							
12		●	●			●							
13	1/2	●		●		●							
14	9/16	●		●		●							
15				●		●							
16	5/8			●		●							
17	11/16			●		●			●				
18				●		●			●				
19	3/4			●		●			●				
20				●		●			●				
21	13/16			●		●			●				
22	7/8			●		●			●				
23				●		●			●				
24	15/16			●		●			●				
25	1					●			●				
26						●			●				
27	1- 1/16					●			●				
28						●			●				
29	1- 1/8					●			●				
30	1- 3/16					●			●				
31						●			●				
32	1- 1/4					●			●				
33	1- 5/16					●			●				
34	1- 3/8					●			●				
36						●			●				
37	1- 7/16					●			●				●
38	1- 1/2					●			●				●
39						●			●				●
40	1- 9/16					●			●				●
41	1- 5/8					●			●				●
42						●			●				●
43	1- 11/16					●			●				●
44						●			●				●
45	1- 3/4					●			●				●
46	1- 13/16					●			●				●
47								●		●			●
48	1- 7/8							●		●			●
	1- 15/16							●		●			●
50								●		●			●
	2							●		●			●
52	2- 1/16							●		●			●
54	2- 1/8							●		●			●
55	2- 3/16							●		●			●
56								●		●			●
	2- 1/4							●		●			●
58	2- 5/16							●		●			●
60	2- 3/8							●		●			●
62	2- 7/16							●		●			●
63								●		●			●
	2- 1/2							●		●			●
65	2- 9/16							●		●			●
67	2- 5/8							●		●			●
68	2- 11/16							●		●			●
70	2- 3/4							●		●			●
	2- 13/16							●		●			●
	2- 7/8							●		●			●
75	2- 15/16							●		●			●
	3							●		●			●
	3- 1/16							●		●			●
80	3- 1/8							●		●			●
	3- 1/4							●		●			●
85								●		●			●
	3- 3/8							●		●			●
90	3- 1/2							●		●			●
	3- 5/8							●		●			●
95	3- 3/4							●		●			●
100	3- 7/8							●		●			●
105	4							●		●			●
	4- 1/8							●		●			●
110	4- 1/4							●		●			●
115	4- 1/2							●		●			●
120	4- 5/8							●		●			●
	4- 3/4							●		●			●
125	4- 7/8							●		●			●
130	5							●		●			●
135	5- 1/4							●		●			●
140								●		●			●
150								●		●			●
	6							●		●			●
	6- 1/2							●		●			●

SOCKETS WITH TURNABLE PLASTIC PROTECTORS
STECKSCHLÜSSEL MIT DREHBAREN SCHUTZHÜLSEN AUS KUNSTSTOFF
DOUILLES A PROTECTIONS PLASTIFIEES



Z-SERIES
 HAND
 TITANIUM
 ACCESSORIES
 SOREWDRIERS
 IMPACT
 SLEEVE-DRIVE
 PROTECTOR
 INDUSTRIAL
 AUTOMOTIVE
 MOTORCYCLE
 CONSTRUCTION
 SPARE PART



Safety

Turnable plastic protector increases operator's safety during assembly process.

Unsere drehbaren Kunststoff-Hülsen erhöhen die Arbeitssicherheit während des Montageprozesses.

Nos protections rotatives plastifiées augmentent la sécurité lors du montage.



Scratch proof

Protector helps to reduce the possibility giving damage on painted, polished and sensitive surfaces. Protector is free rotation designed.

Die Protektoren vermeiden Beschädigungen an lackierten-, polierten- bzw. empfindlichen Oberflächen. Unsere Protektoren sind frei drehbar.

Les protections évitent des endommagements sur des surfaces laquées, polies ou sensibles. Nos protections ont une libre rotation.

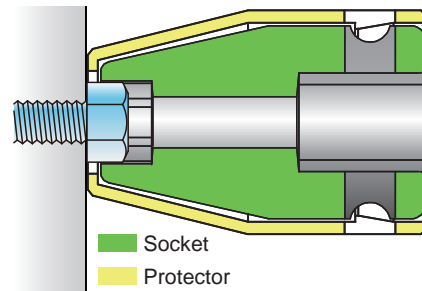

13400M (mm)	D ₁ (mm)	D ₂ (mm)	H (mm)	L (mm)	(g)
8FR	15.7	22	6	33.3	40
10FR	18.2	22	7	33.3	40
12FR	20.8	22	9	33.3	43
13FR	21.8	25	10	33.3	56
14FR	23.6	25	10	33.3	56
16FR	26.1	25	11	33.3	57
17FR	27.3	25	12	33.3	60



13400M-FR

6-point Sockets
6-kant Steckschlüssel
Douilles 6-pans

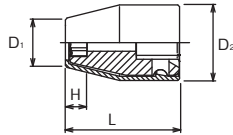

13300M (mm)	D ₁ (mm)	D ₂ (mm)	H ₁ (mm)	H ₂ (mm)	L (mm)	(g)
8FR	16.1	22	9	67.5	81.3	87
10FR	18.6	22	11	67.5	81.3	99
12FR	21.1	22	13	67.5	81.3	116
13FR	22.3	25	14	67.5	81.3	143
14FR	23.6	25	15	67.5	81.3	153
16FR	26	25	17	66.5	81.3	161
17FR	27.2	25	18	66.5	81.3	173

13300M-FR

6-point Sockets, deep
6-kant Steckschlüssel, lang
Douilles longues, 6-pans

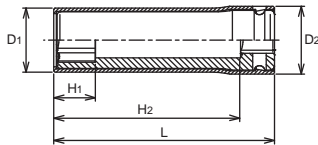
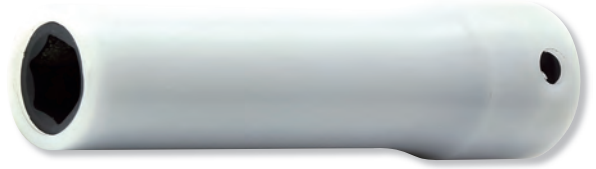

13300G (mm)	D ₁ (mm)	D ₂ (mm)	H ₁ (mm)	H ₂ (mm)	L (mm)	(g)
8FR	16.1	22	5	27.5	81.3	87
10FR	18.6	22	5.5	27	81.3	110
12FR	21.1	22	7	27	81.3	141
13FR	22.3	25	7.5	26	81.3	170
14FR	23.6	25	8	25	81.3	191
16FR	26	25	8.5	28	81.3	215
17FR	27.2	25	9	28	81.3	225

13300G-FR

Impact Socket with Sliding Magnet
Impact Steckschlüssel mit versenkbarem Magnet
Douilles Impact avec aimant, glissant pour écrous

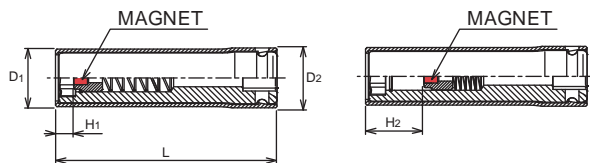
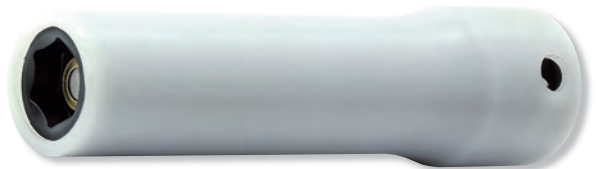

	D (mm)	L (mm)	(g)
13760-75P.FR	26.2	75	100
13760-125P.FR	26.2	125	145
13760-250P.FR	26.2	250	220

13760-P.FR

Extension Bars
Verlängerungen
Rallonges

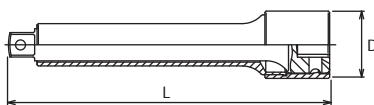

The protector could be broken with any impacts. Please handle with care.

Protector
 Protektorehülsen
 Protections

1/2"



Z-SERIES
 HAND
 TITANIUM
 SCREWDRIVERS
 ACCESSORIES
 IMPACT
 SLEEVE-DRIVE
 PROTECTOR
 INDUSTRIAL
 AUTOMOTIVE
 MOTORCYCLE
 CONSTRUCTION
 SPARE PART

14400M-FR  6-point Sockets
 6-kant Steckschlüssel
 Douilles 6-pans 

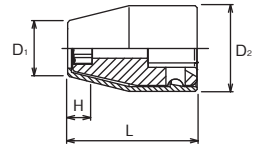

14400M (mm)	D ₁ (mm)	D ₂ (mm)	H (mm)	L (mm)	(g)
10FR	19.5	28	7	39.3	90
12FR	22	28	9	39.3	90
13FR	23.2	28	10	39.3	90
14FR	24.8	28	11	39.3	90
15FR	26.6	33	11	39.3	135
16FR	27	33	10	39.3	135
17FR	28.2	33	12	39.3	135
18FR	30.2	33	13	39.3	135
19FR	31	33	13	39.3	130



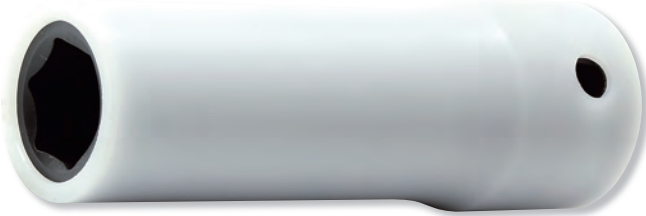

14300M-FR  6-point Sockets, deep
 6-kant Steckschlüssel, lang 
 Douilles longues, 6-pans

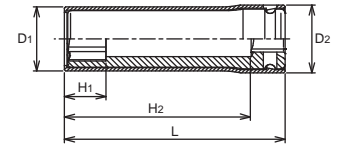

14300M (mm)	D ₁ (mm)	D ₂ (mm)	H ₁ (mm)	H ₂ (mm)	L (mm)	(g)
10FR	19.8	28	11	63	81.3	145
12FR	22.3	28	13	63	81.3	167
13FR	23.5	28	14	63	81.3	167
14FR	24.8	28	15	63	81.3	179
16FR	27.3	33	17	63	81.3	237
17FR	28.5	33	18	63	81.3	237
18FR	29.8	33	18	62	81.3	237
19FR	31	33	20	62	81.3	245



14300G-FR  Impact Socket with Sliding Magnet
 Impact Steckschlüssel mit versenkbarem Magnet  
 Douilles Impact avec aimant, glissant pour écrous

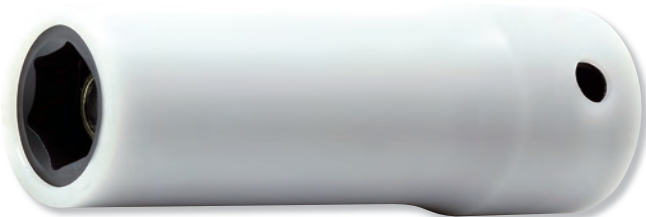

14300G (mm)	D ₁ (mm)	D ₂ (mm)	H ₁ (mm)	H ₂ (mm)	L (mm)	(g)
10FR	19.8	28	5.5	27	81.3	145
12FR	22.3	28	7	27	81.3	170
13FR	23.5	28	7.5	26	81.3	190
14FR	24.8	28	8	25	81.3	194
16FR	27.3	33	8.5	27.5	81.3	275
17FR	28.5	33	9	27.5	81.3	277
19FR	31	33	10	28.5	81.3	313

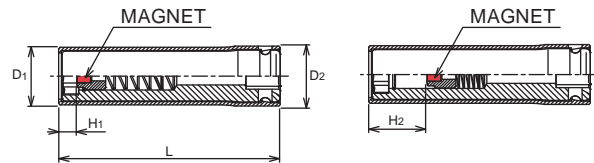

14760-P.FR Extension Bars
 Verlängerungen 
 Rallonges



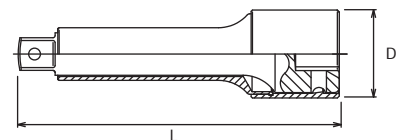

	D (mm)	L (mm)	(g)
14760-75P.FR	34.2	75	195
14760-125P.FR	34.2	125	280
14760-250P.FR	34.2	250	480



 The protector could be broken with any impacts. Please handle with care.

113-75SV / -100SV / -150SV

 Nut Setters
Steckschlüssel Klingen
Embouts pour écrous 

113-75 (mm)	D (mm)	H (mm)	L (mm)	(g)
8SV	15.1	6	75	34
10SV	16.9	7	75	37
12SV	19.4	8	75	44
13SV	20.4	8	75	45
14SV	21.3	9	75	45

113-100 (mm)	D (mm)	H (mm)	L (mm)	(g)
8SV	15.1	6	100	43
10SV	16.9	7	100	47
12SV	19.4	8	100	54
13SV	20.4	8	100	55
14SV	21.3	9	100	55

113-150 (mm)	D (mm)	H (mm)	L (mm)	(g)
8SV	15.1	6	150	62
10SV	16.9	7	150	66
12SV	19.4	8	150	72
13SV	20.4	8	150	80
14SV	21.3	9	150	80



115-75 (mm)	D (mm)	H (mm)	L (mm)	(g)
8SV	15.1	3.5	75	35
10SV	16.9	4.2	75	40
12SV	19.4	5.6	75	48
13SV	20.4	6	75	54
14SV	21.3	6.4	75	54

115-100 (mm)	D (mm)	H (mm)	L (mm)	(g)
8SV	15.1	3.5	100	44
10SV	16.9	4.2	100	52
12SV	19.4	5.6	100	60
13SV	20.4	6	100	67
14SV	21.3	6.4	100	67

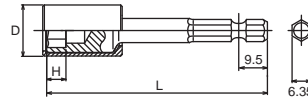
115-150 (mm)	D (mm)	H (mm)	L (mm)	(g)
8SV	15.1	3.5	150	63
10SV	16.9	4.2	150	70
12SV	19.4	5.6	150	79
13SV	20.4	6	150	87
14SV	21.3	6.4	150	87



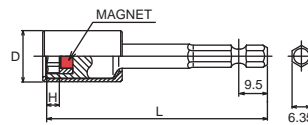

115-75SV / -100SV / -150SV

 Nut Setters with Magnet
Steckschlüssel Klingen mit Magnet
Embouts avec aimant pour écrous  



115G-100FR / -150FR / -200FR

 Nut Setters with sliding Magnet
Steckschlüssel Klingen mit versenkbarem Magnet
Embouts avec aimant, glissant pour écrous  

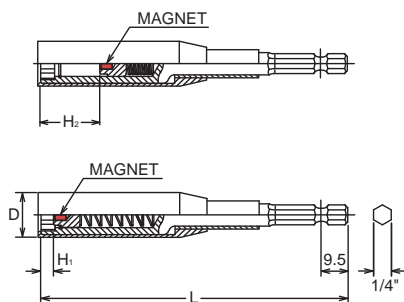

115G-100 (mm)	D (mm)	H ₁ (mm)	H ₂ (mm)	L (mm)	(g)
8FR	15.1	4	26	100	55
10FR	16.9	4.5	26	100	60
12FR	19.3	6	26	100	80
13FR	20.4	6.5	25	100	85
14FR	21.3	7	24	100	85

115G-200 (mm)	D (mm)	H ₁ (mm)	H ₂ (mm)	L (mm)	(g)
8FR	15.1	4	26	200	90
10FR	16.9	4.5	26	200	100
12FR	19.3	6	26	200	125
13FR	20.4	6.5	25	200	135
14FR	21.3	7	24	200	135

115G-150 (mm)	D (mm)	H ₁ (mm)	H ₂ (mm)	L (mm)	(g)
8FR	15.1	4	26	150	75
10FR	16.9	4.5	26	150	80
12FR	19.3	6	26	150	100
13FR	20.4	6.5	25	150	110
14FR	21.3	7	24	150	110

 The protector could be broken with any impacts. Please handle with care.



Specifications or design of any product in this catalogue are subject to change without notice.

Wir behalten uns das Recht vor, jedes in diesem Katalog gezeigte Werkzeug, auch ohne vorherige Ankündigung, in Ausführung und Design ändern zu dürfen.

Nous nous réservons le droit de modifier les modèles et les dimensions des outils présentés dans ce catalogue et ce sans autre notification préalable.



REPLACEMENT

Remove a damaged Protector and put a new Protector on socket / Extension bar by pressing. For your safety, worn out or cracked Protector must be replaced.

AUSTAUSCH

Entfernen Sie defekte Protektoren und ersetzen Sie diese auf Ihrem Steckschlüssel/Verlängerung mittels einer Presse. Bitte tauschen Sie zu Ihrer Sicherheit verschlissene Protektoren aus !

REPLACEMENT

Retirez les protections défectueuses, remplacez celles-ci et fixez-les sur les douilles/rallonges à l'aide d'une presse. Pour votre sécurité remplacez toute protection défectueuse.

INDUSTRIAL SOCKETS

STECKSCHLÜSSEL, INDUSTRIE-AUSFÜHRUNG
CLÉS À DOUILLES, FINISSAGE INDUSTRIEL

1/4"

3/8"

1/2"



◆ INDUSTRIAL SOCKETS



Industrial sockets are thin walled sockets to be used on electric or pneumatic nut runners for assembly work only.

Bei den Industrial Steckschlüsseln handelt es sich um dünnwandige Werkzeuge, die ausschliesslich auf pneumatischen und elektrischen Drehschraubern (nicht schlagend) verwendet werden dürfen.

Les douilles Industrielles à paroi mince ne doivent être utilisées que sur des vis à fixer par visseuses (non-chocs).

22400M 6-point Sockets
6-kant Steckschlüssel
Douilles 6-pans

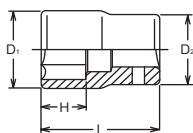

22400M (mm)	D ₁ (mm)	D ₂ (mm)	H (mm)	L (mm)	(g)	(pcs.)
6	9.2	11.2	5.5	22	9	10
7	10.3	11.2	6	22	9	10
8	11.2	11.7	6.9	22	11	10
10	14.3	12.9	7.7	22	15	10
12	16.8	15.5	9.3	22	23	10
13	18	16.4	9.8	22	23	10

22425 TORX® Sockets
TORX® Steckschlüssel
Douilles TORX®

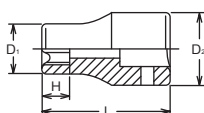

22425 (E)	D ₁ (mm)	D ₂ (mm)	H (mm)	L (mm)	(g)	(pcs.)
E 4	5.4	11.2	4.6	22	7	10
E 5	6.7	11.2	5.2	22	8	10
E 6	7.7	11.2	5.4	22	8	10
E 7	8.3	11.2	6.6	22	9	10
E 8	9.6	11.2	7	22	9	10
E10	11.3	12	8.2	22	10	10

TORX® (E)

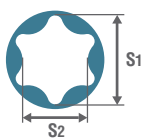

E	E4	E5	E6	E7	E8	E10	E11	E12	E14	E16	E18	E20	E22	E24	E26	E28	E30	E32
S ₁ (ref. mm)	3.7	4.6	5.6	6.1	7.4	9.3	9.9	11.0	12.8	14.6	16.5	18.3	20.1	22.0	23.7	25.5	27.3	29.0
S ₂ (ref. mm)	2.7	3.3	4.0	4.3	5.3	6.8	7.1	7.9	9.2	10.5	11.9	13.2	14.8	15.7	17.5	18.3	20.0	21.3

22300M / 22300A 6-point Sockets, deep
6-kant Steckschlüssel, lang
Douilles longues, 6-pans

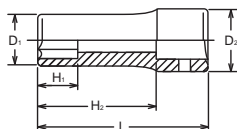

22300M (mm)	D ₁ (mm)	D ₂ (mm)	H ₁ (mm)	H ₂ (mm)	L (mm)	(g)	(pcs.)
7	10.3	11.2	8	40	50	24	10
8	11.2	11.7	9	40	50	28	10
10	14.3	12.9	11	39	50	33	10
12	16.8	15.5	13	39	50	50	10
13	18	16.4	14	39	50	50	10

22300A (inch)	D ₁ (mm)	D ₂ (mm)	H ₁ (mm)	H ₂ (mm)	L (mm)	(g)	(pcs.)
1/4	9.6	11.2	7	40	50	24	10
5/16	11.2	11.7	9	40	50	28	10
3/8	13.7	12.5	11	40	50	33	10

3/8" Steckschlüssel, Industrie-Ausführung Clés à douilles, finissage industriel

23400M (mm)	D ₁ (mm)	D ₂ (mm)	H (mm)	L (mm)	(g)	(pcs.)
6	9.9	17.3	6	26	20	10
7	10.8	17.3	6.5	26	20	10
8	12	17.3	6.9	26	22	10
10	14.5	17.3	8	26	24	10
11	15.8	17.3	9.3	26	25	10
12	16.8	17.3	9	26	25	10
13	18	17	9.4	26	24	10
14	19.5	18.5	11	27	31	10
15	21	19.5	11.5	28	39	10
16	22	20	12	28	42	10
17	23.5	21.5	12.5	29	51	10
18	24.6	22.5	13	30	51	10
19	26	23.5	13.5	30	53	10
21	28	26	14.5	32	77	10

23400A (inch)	D ₁ (mm)	D ₂ (mm)	H (mm)	L (mm)	(g)	(pcs.)
5/16	12	17.3	6.9	26	22	10
3/8	13.9	17.3	8	26	22	10
7/16	15.8	17.3	9.3	26	25	10
1/2	18	17	9.4	26	24	10
9/16	19.5	18.5	11	27	31	10
11/16	24.6	22.5	13	30	51	10
3/4	26	23.5	13.5	30	63	10

23405M (mm)	D ₁ (mm)	D ₂ (mm)	H (mm)	L (mm)	(g)	(pcs.)
8	12	17.3	6.9	26	22	10
10	14.5	17.3	8	26	24	10
12	16.8	17.3	9	26	25	10
14	19.5	18.5	11	27	31	10

23410M (mm)	D ₁ (mm)	D ₂ (mm)	H (mm)	L (mm)	(g)	(pcs.)
8	12	17.3	6.9	26	22	10
10	14.5	17.3	8	26	24	10
12	16.8	17.3	9	26	25	10
13	18	17	9.4	26	24	10
14	19.5	18.5	11	27	31	10
15	21	19.5	11.5	28	39	10
16	22	20	12	28	42	10
17	23.5	21.5	12.5	29	51	10
18	24.6	22.5	13	30	51	10
19	26	23.5	13.5	30	53	10

23425 (E)	D ₁ (mm)	D ₂ (mm)	H (mm)	L (mm)	(g)	(pcs.)
E 5	7	17.3	5.2	26	20	10
E 6	8.3	17.3	5.4	26	21	10
E 7	8.9	17.3	6.6	26	22	10
E 8	9.9	17.3	7	26	23	10
E10	12	17.3	8.2	26	24	10
E11	13.3	17.3	8.7	26	25	10
E12	14.5	17.3	9.3	26	26	10
E14	15.8	17.3	10.6	26	27	10
E16	18	17	11.8	26	27	10



23400M / 23400A

6-point Sockets
6-kant Steckschlüssel
Douilles 6-pans

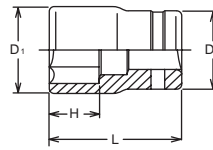

23405M

12-point Sockets
12-kant Steckschlüssel
Douilles 12-pans

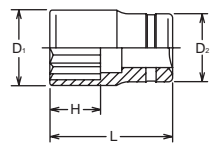

23410M

Surface Drive Sockets
Surface Drive Steckschlüssel
Douilles, Surface Drive

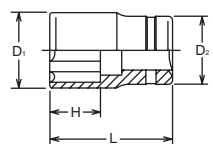

23425

TORX® Sockets
TORX® Steckschlüssel
Douilles TORX®

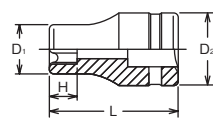

TORX® (E)

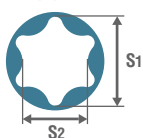

E	E4	E5	E6	E7	E8	E10	E11	E12	E14	E16	E18	E20	E22	E24	E26	E28	E30	E32
S ₁ (ref. mm)	3.7	4.6	5.6	6.1	7.4	9.3	9.9	11.0	12.8	14.6	16.5	18.3	20.1	22.0	23.7	25.5	27.3	29.0
S ₂ (ref. mm)	2.7	3.3	4.0	4.3	5.3	6.8	7.1	7.9	9.2	10.5	11.9	13.2	14.8	15.7	17.5	18.3	20.0	21.3

Industrial Sockets

Steckschlüssel, Industrie-Ausführung

Clés à douilles, finissage industriel

3/8"

Z-SERIES
HAND
TITANIUM
SCREWDRIVERS ACCESSORIES
IMPACT
SLEEVE-DRIVE
PROTECTOR
INDUSTRIAL
AUTOMOTIVE
MOTORCYCLE
CONSTRUCTION
SPARE PART

23300M / 23300A

6-point Sockets, deep
6-kant Steckschlüssel, lang
Douilles longues, 6-pans

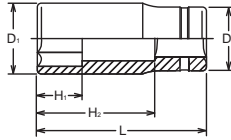

23300M (mm)	D ₁ (mm)	D ₂ (mm)	H ₁ (mm)	H ₂ (mm)	L (mm)	(g)	(pcs.)
7	10.6	17.4	8	41.5	55	40	10
8	12	17.4	9	41.5	55	45	10
10	14.5	17.4	11	41.5	55	52	10
11	16	17.2	12	41.5	55	55	10
12	16.8	17.2	13	41.5	55	58	10
13	18	17	14	41.5	55	57	10
14	20	18	16	41.5	55	68	10
15	21	20	16	40.5	55	78	10
16	22	20	17	40.5	55	79	10
17	23.5	22	18	40.5	55	96	10
18	24.5	23	19	39.5	55	96	10
19	25	24	20	39.5	55	102	10

23305M

12-point Deep Sockets
12-kant Steckschlüssel, lang
Douilles longues 12-pans

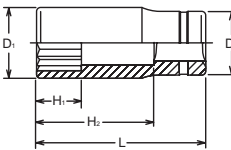

23300A (inch)	D ₁ (mm)	D ₂ (mm)	H ₁ (mm)	H ₂ (mm)	L (mm)	(g)	(pcs.)
5/16	12	17.4	9	41.5	55	45	10
3/8	14	17.4	11	41.5	55	51	10
7/16	16	17.2	12	41.5	55	55	10
1/2	18	17	14	41.5	55	57	10
9/16	20	18	16	41.5	55	68	10
11/16	23.5	22	18	40.5	55	96	10
3/4	25	24	20	39.5	55	102	10

23310M

Surface Drive Sockets, deep
Surface Drive Steckschlüssel, lang
Douilles longues, Surface Drive

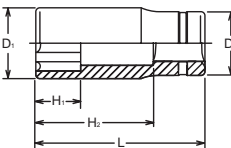

23305M (mm)	D ₁ (mm)	D ₂ (mm)	H ₁ (mm)	H ₂ (mm)	L (mm)	(g)	(pcs.)
8	12	17.4	9	41.5	55	45	10
10	14.5	17.4	11	41.5	55	52	10
12	16.8	17.2	13	41.5	55	58	10
14	20	18	16	41.5	55	68	10

23310M (mm)	D ₁ (mm)	D ₂ (mm)	H ₁ (mm)	H ₂ (mm)	L (mm)	(g)	(pcs.)
8	12	17.4	9	41.5	55	45	10
10	14.5	17.4	11	41.5	55	52	10
12	16.8	17.2	13	41.5	55	58	10
13	18	17	14	41.5	55	57	10
14	20	18	16	41.5	55	68	10
15	21	20	16	40.5	55	80	10
17	23.5	22	18	40.5	55	96	10

23325

TORX® Deep Sockets
TORX® Steckschlüssel, lang
Douilles longues TORX®

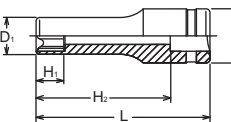

23325 (E)	D ₁ (mm)	D ₂ (mm)	H ₁ (mm)	H ₂ (mm)	L (mm)	(g)	(pcs.)
E 5	6.9	17.4	5.2	41.5	55	50	10
E 6	7.9	17.4	5.4	41.5	55	52	10
E 7	8.9	17.4	6.6	41.5	55	55	10
E 8	9.9	17.4	7	41.5	55	58	10
E10	11.8	17.2	8.2	41.5	55	60	10
E12	14.5	17.2	9.3	41.5	55	68	10
E14	15.7	17.2	10.6	41.5	55	77	10
E16	18	17	11.8	41.5	55	80	10

23103M

Stud Bolt Setter with unlocking system
Stehbolzensetzer mit Entriegelungssystem
Monte-goujons avec système de déverrouillage

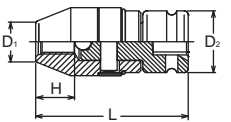

23103M (mm)	D ₁ (mm)	D ₂ (mm)	H (mm)	L (mm)	(g)	(pcs.)	(pcs.)
New 6(1.0)	11.1	22	9	59	175	10	*1
New 8(1.25)	13.6	22	11	61	181	10	*1
New 10(1.25)	16	22	13	63	188	10	*1
New 10(1.5)	16	22	13	63	188	10	*1

*1 C-Ring=C32, Pin/O-Ring=A32/B32 → P268-269

This item is not suitable for Impact Drivers.



The tool should only be used with non-impacting electric screwdrivers.

Das Werkzeug ist nicht für Schlagschrauber geeignet.

Das Werkzeug sollte ausschließlich mit nicht schlagenden Elektroschraubern verwendet werden.

L'outil n'est pas adapté aux visseuses à chocs.

L'outil doit être utilisé exclusivement avec des visseuses électriques non percutantes.

23760-P

Extension Bars
Verlängerungen
Rallonges



	D (mm)	L (mm)	(g)	(pcs.)
23760-75P	18	75	70	10
23760-125P	18	125	110	10
23760-250P	18	250	200	5

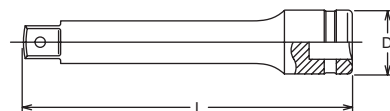

1/2"

Industrial Sockets
Steckschlüssel, Industrie-Ausführung
Clés à douilles, finissage industriel

24400M (mm)	D ₁ (mm)	D ₂ (mm)	H (mm)	L (mm)	(g)	(pcs.)
10	15.3	21	9	37	45	10
11	16.5	21	9.5	37	46	10
12	17.8	21	10	37	47	10
13	19	22	10.5	37	53	10
14	20.3	22	11	37	56	10
15	21.5	22	11.5	37	52	10
16	22.8	22	12	37	62	10
17	24.1	23	12.5	37	69	10
18	25.1	24	13	37	74	10
19	26.6	25	14	38	89	10
20	27.9	26	15	38	92	10
21	29.1	27	15.5	38	102	10
22	30.1	28	16	40	113	10
23	31.5	29	16.5	40	128	10
24	32.9	30	17	42	140	5
26	35	32	19	42	165	5
27	36.5	33	19.5	43	196	5
29	39	35	20.5	43	190	5
30	40	36	22	46	222	5
32	42.8	38	23	46	250	5

24400A (inch)	D ₁ (mm)	D ₂ (mm)	H (mm)	L (mm)	(g)	(pcs.)
7/16	16.5	21	9.5	37	46	10
1/2	19	22	10.5	37	53	10
9/16	20.3	22	11	37	56	10
5/8	22.9	22	12	37	62	10
3/4	26.6	25	14	38	89	10
15/16	32.9	30	17	42	140	10

24405M (mm)	D ₁ (mm)	D ₂ (mm)	H (mm)	L (mm)	(g)	(pcs.)
10	15.3	21	9	37	45	10
12	17.8	21	10	37	47	10
14	20.3	22	11	37	56	10
17	24.1	23	12.5	37	69	10
19	26.6	25	14	38	89	10

24410M (mm)	D ₁ (mm)	D ₂ (mm)	H (mm)	L (mm)	(g)	(pcs.)
10	15.3	21	9	37	45	10
12	17.8	21	10	37	47	10
13	19	22	10.5	37	53	10
14	20.3	22	11	37	56	10
15	21.5	22	11.5	37	52	10
16	22.8	22	12	37	62	10
17	24.1	23	12.5	37	69	10
18	25.1	24	13	37	74	10
19	26.6	25	14	38	89	10
21	29.1	27	15.5	38	102	10
22	30.1	28	16	40	113	10
24	32.9	30	17	42	140	10

24425 (E)	D ₁ (mm)	D ₂ (mm)	H (mm)	L (mm)	(g)	(pcs.)
E10	13.2	21	8.2	36	68	10
E12	14.6	21	9.3	37	70	10
E14	16.5	21	10.6	37	75	10
E16	19	21.9	11.8	37	80	10
E18	20.3	21.9	13	37	83	10
E20	22.9	22	14.4	37	121	10



24400M / 24400A

6-point Sockets
6-kant Steckschlüssel
Douilles 6-pans

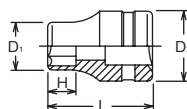

24405M

12-point Sockets
12-kant Steckschlüssel
Douilles 12-pans

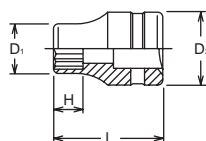

24410M

Surface Drive Sockets
Surface Drive Steckschlüssel
Douilles, Surface Drive

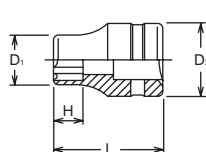

24425

TORX® Sockets
TORX® Steckschlüssel
Douilles TORX®

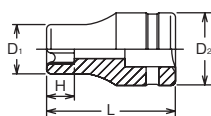

TORX® (E)

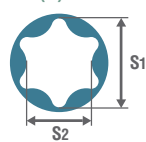

E	E4	E5	E6	E7	E8	E10	E11	E12	E14	E16	E18	E20	E22	E24	E26	E28	E30	E32
S ₁ (ref. mm)	3.7	4.6	5.6	6.1	7.4	9.3	9.9	11.0	12.8	14.6	16.5	18.3	20.1	22.0	23.7	25.5	27.3	29.0
S ₂ (ref. mm)	2.7	3.3	4.0	4.3	5.3	6.8	7.1	7.9	9.2	10.5	11.9	13.2	14.8	15.7	17.5	18.3	20.0	21.3

TORX is a registered trademark of CAMCAR Innovations.
TORX ist ein registriertes Markenzeichen der Firma CAMCAR Innovations.
TORX est une marque déposée de CAMCAR Innovations.

Industrial Sockets

Steckschlüssel, Industrie-Ausführung

Clés à douilles, finissage industriel

1/2"

Z-SERIES
HAND
TITANIUM
SCREWDRIVERS ACCESSORIES
IMPACT
SLEEVE-DRIVE
PROTECTOR
INDUSTRIAL
AUTOMOTIVE
MOTORCYCLE
CONSTRUCTION
SPARE PART

24300M / 24300A

6-point Sockets, deep
6-kant Steckschlüssel, lang
Douilles longues, 6-pans

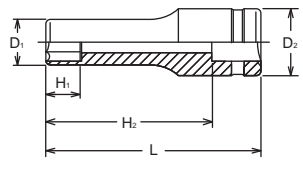

24300M (mm)	D ₁ (mm)	D ₂ (mm)	H ₁ (mm)	H ₂ (mm)	L (mm)	(g)	(pcs.)
10	15.3	21	11	59	77	91	10
11	16.5	21	12	59	77	95	10
12	17.8	21	13	59	77	99	10
13	19	21.8	14	59	77	107	10
14	20.3	21.8	16	59	77	118	10
15	21.5	21.8	16	59	77	123	10
16	22.8	22	17	59	77	141	10
17	24	23	18	59	77	150	10
18	25	24	19	59	77	164	10
19	26.5	25	20	58	77	177	10
20	27.8	26	21	58	77	178	10
21	29	27	23	58	77	187	10
22	30	28	27	57	77	202	10
23	31.5	29	27	57	77	235	10
24	32.8	30	27	57	77	252	10
27	36.5	33	28	56	77	303	10
30	40	36	34	55	77	342	10
32	42.8	38	34	55	77	405	10

24305M

12-point Deep Sockets
12-kant Steckschlüssel, lang
Douilles longues 12-pans

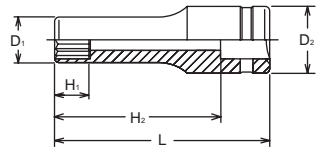

24300A (inch)	D ₁ (mm)	D ₂ (mm)	H ₁ (mm)	H ₂ (mm)	L (mm)	(g)	(pcs.)
7/16	16.5	21	12	59	77	95	10
1/2	19	21.8	14	59	77	107	10
9/16	20.3	21.8	15	59	77	118	10
5/8	22.8	22	17	59	77	141	10
21/32	24	23	18	59	77	150	10
11/16	25	24	19	59	77	164	10
3/4	26.5	25	20	58	77	177	10
13/16	29	27	23	58	77	187	10
15/16	32.8	30	27	57	77	252	10

24305M (mm)	D ₁ (mm)	D ₂ (mm)	H ₁ (mm)	H ₂ (mm)	L (mm)	(g)	(pcs.)
10	15.3	21	11	59	77	91	10
12	17.8	21	13	59	77	99	10
14	20.3	21.8	16	59	77	118	10
17	24	23	18	59	77	150	10
19	26.5	25	20	58	77	177	10

24310M

Surface Drive Sockets, deep
Surface Drive Steckschlüssel, lang
Douilles longues, Surface Drive

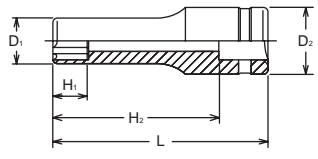

24310M (mm)	D ₁ (mm)	D ₂ (mm)	H ₁ (mm)	H ₂ (mm)	L (mm)	(g)	(pcs.)
10	15.3	21	11	59	77	91	10
12	17.8	21	13	59	77	99	10
13	19	21.8	14	59	77	107	10
14	20.3	21.8	16	59	77	118	10
15	21.5	21.8	16	59	77	123	10
16	22.8	22	17	59	77	141	10
17	24	23	18	59	77	150	10
18	25	24	19	59	77	160	10
19	26.5	25	20	58	77	177	10
21	29	27	23	58	77	187	10
22	30	28	27	57	77	202	10
24	32.8	30	27	57	77	250	10

24103M

Stud Bolt Setter with unlocking system
Stehbolzensetzer mit Entriegelungssystem
Monte-goujons avec système de déverrouillage

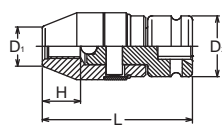

24103M (mm)	D ₁ (mm)	D ₂ (mm)	H (mm)	L (mm)	(g)	(pcs.)	(pcs.)
New 8(1.25)	15.4	30	15	69	332	10	*1
New 10(1.25)	17.8	30	18	72	344	10	*1
New 10(1.5)	17.8	30	18	72	344	10	*1
New 12(1.75)	20.2	30	19	74	352	10	*1

*1 C-Ring=C42, Pin/O-Ring=A42/B42 → P268-269
This item is not suitable for Impact Drivers.
The tool should only be used with non-impacting electric screwdrivers.
Das Werkzeug ist nicht für Schlagschrauber geeignet.
Das Werkzeug sollte ausschließlich mit nicht schlagenden Elektroschraubern verwendet werden.
L'outil n'est pas adapté aux visseuses à chocs.
L'outil doit être utilisé exclusivement avec des visseuses électriques non percutantes.

24760-P

Extension Bars
Verlängerungen
Rallonges



	D (mm)	L (mm)	(g)	(pcs.)
24760-75P	24	75	140	10
24760-125P	24	125	200	5
24760-250P	24	250	370	5

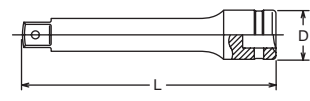

AUTOMOTIVE TOOLS
WERKZEUGE FÜR KFZ UND NUTZFAHRZEUGE
OUTILS POUR POIDS LOURDS ET VÉHICULES UTILITAIRES



Z-SERIES
 HAND
 TITANIUM
 SCREWDRIVERS ACCESSORIES
 IMPACT
 SLEEVE-DRIVE
 PROTECTOR
 INDUSTRIAL
 AUTOMOTIVE
 MOTORCYCLE
 CONSTRUCTION
 SPARE PART

3300C / 4300C

Spark Plug Sockets with Spring Clips
 Zündkerzen-Schlüssel mit Haltefeder
 Douille avec ressorts de retenue pour bougies

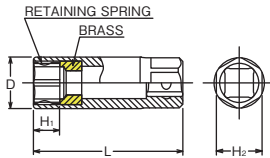
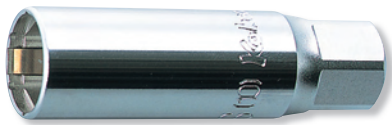

Spring clip type spark plug sockets caused deforming the clip, if it would be used with shallow engagement.

Zündkerzen-Schlüssel mit Haltefedern müssen korrekt auf die Zündkerze gesteckt werden. Ansonsten kann sich die Halteklammer verbiegen.

Les douilles de bougies d'allumage à clip à ressort ont causé la déformation du clip, s'il était utilisé avec un engagement peu profond.

3300C (mm)		D (mm)	H ₁ (mm)	H ₂ (mm)	L (mm)	(g)	(pcs.)
13	3/8"	17.5	11	17	70	66	10
14		19	11	17	70	82	10
16		20.5	13	17	70	91	10
18		23.9	12	21	70	140	10
20.8		26.9	13.5	22	70	132	10

4300C (mm)		D (mm)	H ₁ (mm)	H ₂ (mm)	L (mm)	(g)	(pcs.)
16	1/2"	21	13	21	70	101	10
18		23.9	12	21	70	132	10
20.8		26.9	13.5	22	70	130	10

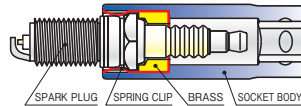

Spark Plug Sockets with Spring Clip

An internal brass guide holds the clips in place, which ensures perfect alignment of the spark plug into the threaded plug hole of cylinder head, thus preventing thread damage. The brass guide also eliminates stress loading and possible damage to the ceramic insulator of the spark plug.

Zündkerzenstecker mit Federklemme

Eine interne Messingführung hält die Clips an ihrem Platz, was eine perfekte Ausrichtung der Zündkerze in der Gewindebohrung des Zylinderkopfes gewährleistet und somit eine Beschädigung des Gewindes verhindert. Die Messingführung eliminiert auch Stressbelastung und mögliche Schäden an dem Keramikisolator der Zündkerze.

Douilles pour bougies d'allumage avec clip à ressort

Un guide interne en laiton maintient les clips en place, ce qui assure un alignement parfait de la bougie d'allumage dans le trou fileté de la culasse, évitant ainsi d'endommager le filetage. Le guide en laiton élimine également les contraintes et les risques d'endommagement de l'isolant en céramique de la bougie d'allumage.

3300CB

Spark Plug Socket (BMW)
 Zündkerzen-Schlüssel (BMW)
 Douille pour bougies (BMW)

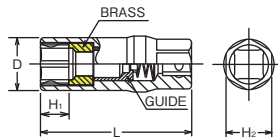

3300CB (mm)		D (mm)	H ₁ (mm)	H ₂ (mm)	L (mm)	(g)	(pcs.)
16	3/8"	22.8	13	19	65	118	10



Spring clip type spark plug sockets caused deforming the clip, if it would be used with shallow engagement.

Zündkerzen-Schlüssel mit Haltefedern müssen korrekt auf die Zündkerze gesteckt werden. Ansonsten kann sich die Halteklammer verbiegen.

Les douilles de bougies d'allumage à clip à ressort ont causé la déformation du clip, s'il était utilisé avec un engagement peu profond.

3300P

Spark Plug Socket with Magnet
 Zündkerzensteckschlüssel mit Magnet
 Douille pour bougies, avec aimant

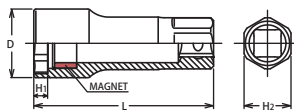

3300P (mm)		D (mm)	H ₁ (mm)	H ₂ (mm)	L (mm)	(g)	(pcs.)
19	3/8"	24.8	5	17	65	88	10

19mm spark plug for generators, grass trimmers and chainsaws.

19mm Zündkerzen für Generatoren, Rasenmäher und Motorsägen.

Douille pour bougies de 19 mm pour les générateurs, les coupe-herbes et les tronçonneuses.



The magnet can break by any impacts. Please handle with care.

Der Magnet kann durch Stöße beschädigt werden. Bitte mit Vorsicht handhaben.

L'aimant peut être brisé par n'importe quel impact. Veuillez le manipuler avec précaution.

3305P

Spark Plug Socket with Magnet, 12-pt. opening
 Zündkerzensteckschlüssel mit Magnet, 12-kant
 Douille pour bougies, avec aimant, 12-pans

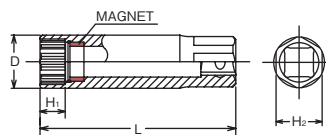
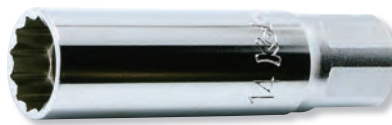

3305P (mm)		D (mm)	H ₁ (mm)	H ₂ (mm)	L (mm)	(g)	(pcs.)
12	3/8"	16.5	6.3	-	70	78	10
14		19	8	17	70	87	10
16		20.5	8	17	70	100	10

Spark Plug Socket with Magnet, 12-pt. opening: 3305P-14



The magnet can break by any impacts. Please handle with care.

Der Magnet kann durch Stöße beschädigt werden. Bitte mit Vorsicht handhaben.

L'aimant peut être brisé par n'importe quel impact. Veuillez le manipuler avec précaution.

3300S (mm)		D (mm)	H ₁ (mm)	H ₂ (mm)	L (mm)	(g)	(pcs.)
16	3/8"	20.9	19	17	70	100	10
18		23.9	21	21	70	145	10
20.8		26.9	27	22	70	140	10

4300S (mm)		D (mm)	H ₁ (mm)	H ₂ (mm)	L (mm)	(g)	(pcs.)
16	1/2"	21	19	21	70	100	10
18		23.9	21	21	70	130	10
20.8		26.9	27	22	70	135	10

3300S / 4300S

Spark Plug Sockets with Rubber
Zündkerzen-Schlüssel mit Gummeinsatz
Douille pour bougies avec caoutchouc

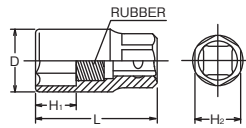

3300C-180 (mm)		D ₁ (mm)	D ₂ (mm)	H (mm)	L (mm)	(g)	(pcs.)
14	3/8"	19	18	11	180	205	5
16		20.5	18	13	180	220	5
20.8		26.9	18	13.5	180	260	5

3300C-180 / -250

Spark Plug Sockets with Spring Clips
Zündkerzen-Schlüssel mit Haltefedern
Douille avec ressorts de retenue pour bougies

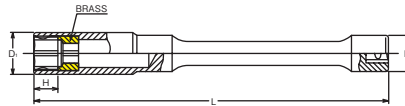

3300C-250 (mm)		D ₁ (mm)	D ₂ (mm)	H (mm)	L (mm)	(g)	(pcs.)
14	3/8"	19	18	11	250	271	5
16		20.5	18	13	250	290	5
20.8		26.9	18	13.5	250	340	5



Spring clip type spark plug sockets caused deforming the clip, if it would be used with shallow engagement.

Zündkerzen-Schlüssel mit Haltefedern müssen korrekt auf die Zündkerze gesteckt werden. Ansonsten kann sich die Halteklammer verbiegen.

Les douilles pour bougies avec clips à ressorts doivent être correctement insérées sur la bougie d'allumage. Dans le cas contraire la pince de maintien peut se déformer.

3305P-250

Spark Plug Socket with Magnet, 12pt. opening
Zündkerzensteckschlüssel mit Magnet, 12-kant
Douille pour bougies, avec aimant, 12-pans

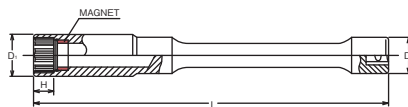

3305P-250 (mm)		D ₁ (mm)	D ₂ (mm)	H (mm)	L (mm)	(g)	(pcs.)
14	3/8"	19	18	8	250	250	5

The magnet can break by any impacts. Please handle with care.
Der Magnet kann durch Stöße beschädigt werden. Bitte mit Vorsicht handhaben.
L'aimant peut être brisé par n'importe quel impact. Veuillez le manipuler avec précaution.

3340C (mm)		D ₁ (mm)	D ₂ (mm)	H (mm)	L (mm)	(g)	(pcs.)
14	3/8"	19	19	11	88	109	10
16		21	19	13	88	122	10
18		23.9	19	12	88	145	10
20.8		26.8	19	13.5	88	174	10

3340C 4340C

Universal Spark Plug Sockets with Spring Clips
Gelenk-Zündkerzenschlüssel mit Haltefeder
Douille articulée avec ressorts de retenue pour bougies

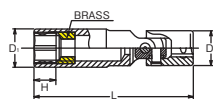

4340C (mm)		D ₁ (mm)	D ₂ (mm)	H (mm)	L (mm)	(g)	(pcs.)
16	1/2"	21	25	13	107	220	10
20.8		26.8	25	13.5	107	250	10

Spring clip type spark plug sockets caused deforming the clip, if it would be used with shallow engagement.
Zündkerzen-Schlüssel mit Haltefedern müssen korrekt auf die Zündkerze gesteckt werden. Ansonsten kann sich die Halteklammer verbiegen.
Les douilles pour bougies avec clips à ressorts doivent être correctement insérées sur la bougie d'allumage. Dans le cas contraire la pince de maintien peut se déformer.

3345P

Universal Spark Plug Socket with Magnet, 12-point opening
Gelenk-Zündkerzensteckschlüssel mit Magnet, 12-kant Ausführung
Clé pour bougies à déclenchement articulée avec aimant, 12 pans

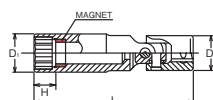

3345P (mm)		D ₁ (mm)	D ₂ (mm)	H (mm)	L (mm)	(g)	(pcs.)
14	3/8"	19	19	8	88	110	10

The magnet can break by any impacts. Please handle with care.
Der Magnet kann durch Stöße beschädigt werden. Bitte mit Vorsicht handhaben.
L'aimant peut être brisé par n'importe quel impact. Veuillez le manipuler avec précaution.

Z-SERIES
 HAND
 TITANIUM
 ACCESSORIES
 SCREWDRIVERS
 IMPACT
 SLEEVE-DRIVE
 PROTECTOR
 INDUSTRIAL
 AUTOMOTIVE
 MOTORCYCLE
 CONSTRUCTION
 SPARE PART

127C  T-type Universal Spark Plug Socket Wrench
 T-Griff mit Gelenk-Zündkerzenschlüssel
 Poignée en T avec douille universelle pour bougies



127C-315 (mm)	D (mm)	H (mm)	L ₁ (mm)	L ₂ (mm)	(g)	(pce.)
14	19	11	315	150	520	1
16	21	13	315	150	530	1
18	23.9	12	315	150	590	1
20.8	26.8	13.5	315	150	590	1

 Spring clip type spark plug sockets caused deforming the clip, if it would be used with shallow engagement.

Zündkerzen-Schlüssel mit Haltefedern müssen korrekt auf die Zündkerze gesteckt werden. Ansonsten kann sich die Halteklammer verbiegen.

Les douilles pour bougies avec clips à ressorts doivent être correctement insérées sur la bougie d'allumage. Dans le cas contraire la pince de maintien peut se déformer.

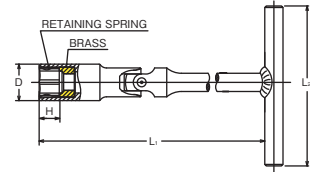

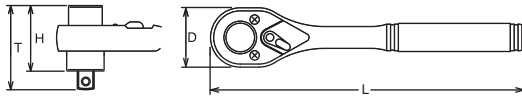

3751J Torque Ratchet for Spark plugs
 Drehmoment-Knarre für Zündkerzen
 Cliquet pour bougies à déclenchement 25Nm



		D (mm)	T (mm)	H (mm)	L (mm)	(g)	(pce.)
3751J-25	3/8"	34	57	43	178	320	1

3225A Set for Torque Controlled Installation of Spark Plugs
 Set zur Drehmoment kontrollierten Montage von Zündkerzen
 Jeu qui permet la rotation contrôlée lors du montage des bougies à déclenchement

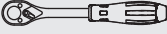

3225A		4 Pieces Set/△=960g	
METAL CASE:W215xH80xT47mm			
Sockets		Accessories	
	3300C Spark Plug Sockets 16, 20.8		3751J-25
			3763-125



2350G-PSG (mm)		D ₁ (mm)	D ₂ (mm)	H ₁ (mm)	H ₂ (mm)	L (mm)	 (g)	 (pcs.)
12	1/4"	16.5	15.5	12	41	50	41	10



2350G-12PSG

NUT GRIP® Sockets for PSG-Glow Plugs
Steckschlüssel für PSG-Glühkerzen
Douille pour bougies PSG

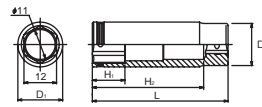

3341G-70 (mm)		D ₁ (mm)	D ₂ (mm)	H (mm)	L (mm)	 (g)	 (pcs.)
10	3/8"	14.5	19	6	70	76	10
11		15.8	19	6	70	80	10
12		17	19	6	70	85	10

3341G-70 / -89

Universal PSG Glow Plug Socket with NUT GRIP®
Gelenksteckschlüssel für PSG-Glühkerzen mit 2fach Kugelhalterung
Douille articulée pour bougies de préchauffement PSG, avec le système de billes de retenue, double.

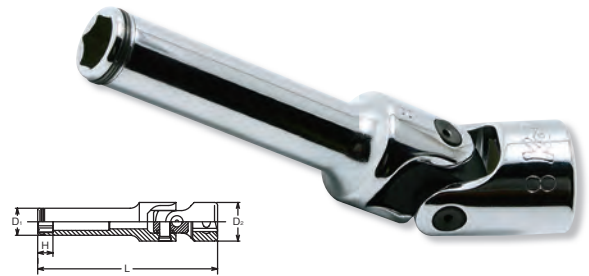

3341G-89 (mm)		D ₁ (mm)	D ₂ (mm)	H (mm)	L (mm)	 (g)	 (pcs.)
8	3/8"	12	19	7.5	89	82	10
9		13.3	19	7.5	89	87	10
10		14.5	19	6	89	92	10
12(DP52)		17	19	14	89	101	10

GLOW PLUG SOCKETS, NUT GRIP®

Twin balls at the 6-point opening hold bolt/nut tightly for safe and reliable work.

Die zwei Kugeln in der 6-kant Öffnung unserer NUT GRIP® Glühkerzensteckschlüssel halten die Zündkerze sicher im Steckschlüssel. Dies erlaubt ein Arbeiten auch an schwer zugänglichen Stellen.

Les deux billes se trouvant dans l'ouverture de notre NUT GRIP® (6 pans) pour bougies de préchauffement, maintiennent la bougie de déclenchement dans la douille. Ceci permet l'accès dans les endroits difficilement accessibles.



3342G-150 (mm)		D ₁ (mm)	D ₂ (mm)	H (mm)	L (mm)	 (g)	 (pcs.)
8	3/8"	12	18	7.5	150	137	10

3342G-150

Deep length universal Glow Plug Socket
Extra langer Glühkerzen-Steckschlüssel mit Gelenk
Douille articulée pour bougies de préchauffement, extra longue

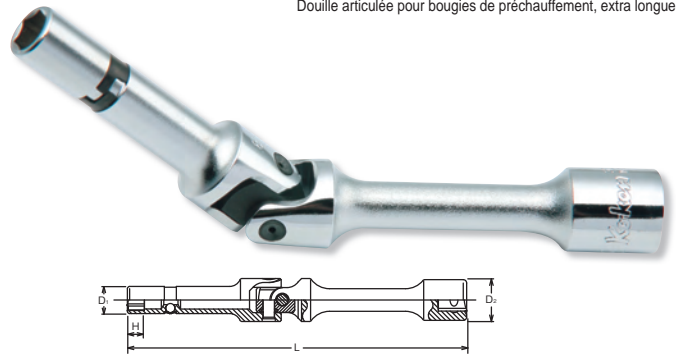

178-10H (mm)	D (mm)	H ₁ (mm)	H ₂ (mm)	S (mm)	L (mm)	 (g)	 (pcs.)
9	13	6.5	10	6.7	50	16	10

178-10H

For Glow Plugs
Für Glühkerzen
Pour bougies de préchauffement



144KM (mm)	L (mm)	D (mm)	C (mm)	 (g)	 (pce.)
8	200	22.7	7.5	95	1
12	200	22.7	7.5	102	1

144KM

For Glow Plugs
Für Glühkerzen
Pour bougies de préchauffement

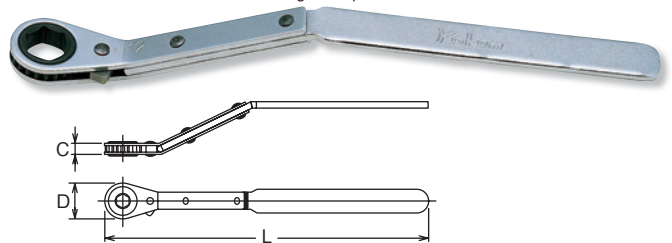

148KM (mm)	L (mm)	D ₁ (mm)	D ₂ (mm)	C (mm)	 (g)	 (pce.)
8Sx12	245	23.6	24.6	9	187	1

148KM

For Glow Plugs
Für Glühkerzen
Pour bougies de préchauffement

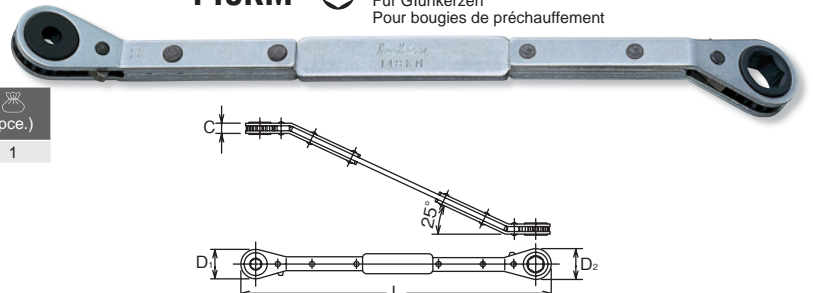

Z-SERIES
 HAND
 TITANIUM
 SCREWDRIVERS ACCESSORIES
 IMPACT
 SLEEVE-DRIVE
 PROTECTOR
 INDUSTRIAL
 AUTOMOTIVE
 MOTORCYCLE
 CONSTRUCTION
 SPARE PART

SP4305M-77  Socket for Diesel engine injectors
 Steckschlüssel für Diesel-Einspritzdüsen
 Douilles spéciales pour injecteurs

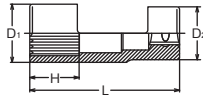
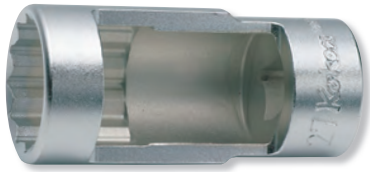

SP4305M-77 (mm)		D ₁ (mm)	D ₂ (mm)	H (mm)	L (mm)	(g)	(pcs.)
27	1/2"	36.5	33	28	77	212	10

SP4305M.77-27
 For fuel injection pump of BMW diesel cars.
 Für die Einspritzpumpe von BMW-Dieselfahrzeugen.
 Pour la pompe d'injection de carburant des voitures diesel BMW.

4133  Socket for Diesel engine injectors
 Steckschlüssel für Diesel-Einspritzdüsen
 Douilles spéciales pour injecteurs

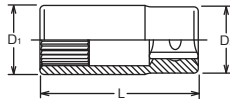

	D ₁ (mm)	D ₂ (mm)	L (mm)	(g)	(pcs.)	
4133	1/2"	23.9	23	55	86	10

4133
 For fuel injection pump of M.B. diesel cars.
 Für die Einspritzpumpe von M.B. Dieselfahrzeugen.
 Pour la pompe d'injection de carburant des voitures diesel M.B.

4122-72 Diesel Injection Holder Nut Socket
 Steckschlüssel für Einspritzdüsen
 Douilles pour injecteur diesel

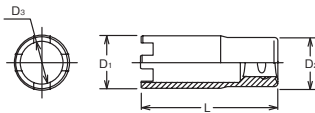

4122-72 (mm)		D ₁ (mm)	D ₂ (mm)	D ₃ (mm)	L (mm)	(g)	(pcs.)
22	1/2"	28.5	27	22	72	150	10

4122.72-22
 For M.B. Trucks, Holder nut on injection post.
 Für M.B. Trucks, Haltemutter an der Einspritzdüse.
 Pour les camions M.B., l'écrou de fixation se trouve sur le poteau d'injection.

SP4122-69 Diesel Injection Holder Nut Socket
 Steckschlüssel für Einspritzdüsen
 Douilles pour injecteur diesel

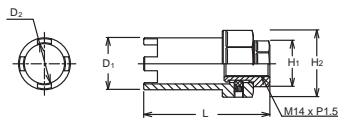

SP4122-69 (mm)	D ₁ (mm)	D ₂ (mm)	H ₁ (mm)	H ₂ (mm)	L (mm)	(g)	(pcs.)
22	28.4	22	22	32	69	185	5

3300FN  Flare Nut Sockets
 Geschlitzte Steckschlüssel für Überwurfmutter
 Douilles à tuyauter

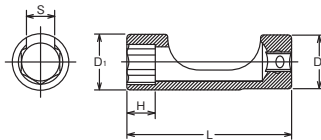

3300FN (mm)		D ₁ (mm)	D ₂ (mm)	H (mm)	L (mm)	S (mm)	(g)	(pcs.)
8	3/8"	14.5	17.3	6	53	6.4	38	10
9		16	17.3	7	53	6.8	41	10
10		16.8	17.2	7.5	53	7.2	42	10
11		18	17	8.5	53	8.3	42	10
12		20	18	9	53	8.8	50	10
13		21.1	20	9.5	62	9.4	66	10
14		22	20	10.5	62	10.5	66	10
15		23	22	11	70	11.5	82	10
16		24	23	11.5	70	12	90	10
17		25	24	12.5	80	13	110	10
18		27	25	13	80	13.5	120	10
19		28	26	14	80	14.5	130	10
21		30	27.5	15	80	15.5	170	10
22		32	29.5	16	80	16	180	10
24	34.5	31.5	17	80	17	200	10	

RS3300FN/8	8 Pieces Set/Rail 200mm	(g)
9, 10, 11, 13, 14, 16, 17, 19		600

RS3300FN/8   Socket Set on Rail
 Steckschlüsselsatz auf Schiene
 Jeu de douilles sur rail

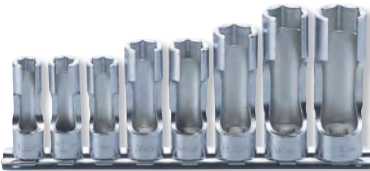

	D ₁ (mm)	D ₂ (mm)	H (mm)	L (mm)	S (mm)	(g)	(pcs.)	
SP4300M.85-22	1/2"	33	30	29	85	8	228	10
SP4300M.110-22		33	30	34	110	8	279	5

SP4300M-85  Special socket for Lambda Probes
 Spezialsteckschlüssel für Lambda Sonden
SP4300M-110  Douilles spéciales pour sonde Lambda

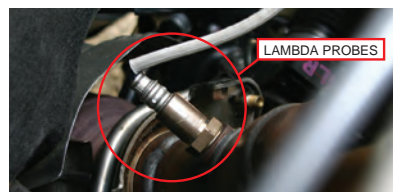
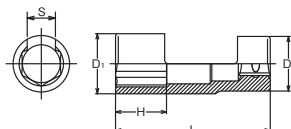
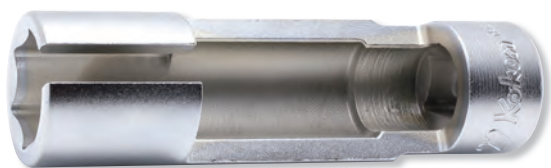

Socket for Lambda Probes
 Open section allows for use with wire/connector.

Steckschlüssel für Lambdasonden
 Offener Abschnitt ermöglicht die Verwendung mit montiertem Draht/Stecker.

Prise pour sondes Lambda
 La section ouverte permet l'utilisation d'un fil/connecteur.

Z-SERIES
HAND
TITANIUM
ACCESSORIES
SCREWDRIVERS
IMPACT
SLEEVE-DRIVE
PROTECTOR
INDUSTRIAL
AUTOMOTIVE
MOTORCYCLE
CONSTRUCTION
SPARE PART

4300H (mm)		D ₁ (mm)	D ₂ (mm)	H ₁ (mm)	H ₂ (mm)	H ₃ (mm)	L (mm)	(g)	(pcs.)
24	1/2"	32.5	27	17	40	24	57	157	10
26		35	27	19	40	24	57	170	10
27		36.1	27	19.5	40	24	57	175	10

4300H series

Removes and installs oil pressure switches
Demontage und Montage von Öldruckschaltern
Démonte et installe les interrupteurs de pression d'huile

4300H (mm)		D ₁ (mm)	D ₂ (mm)	H ₁ (mm)	H ₂ (mm)	L (mm)	(g)	(pcs.)
27(8P)	1/2"	34	27	14	37	57	152	10

4300H(8P) series

Socket for switches, Mercedes Benz and MAN
Steckschlüssel für Schalter, Mercedes Benz und MAN
Prise pour interrupteurs, Mercedes Benz et MAN

4010M-100 (mm)		D (mm)	H (mm)	L (mm)	(g)	(pcs.)
8(12P)	1/2"	23	63.5	100	132	10
10(12P)		23	63.5	100	135	10

4010M-120 (mm)		D (mm)	H (mm)	L (mm)	(g)	(pcs.)
8(12P)	1/2"	23	83.5	120	151	10
10(12P)		23	83.5	120	155	10



Cylinder head bolt for Toyota
4010M(12P) is double Hex Bit socket
XZN(Triple Square) bit socket has different shape.

Zylinderkopfschraube für Toyota
4010M(12P) ist ein Doppel-Sechskant Einsatz
Ein XZN (Triple Square) Bit hat eine andere Form.

Boulon de culasse pour Toyota
4010M(12P) est une douille à double embout hexagonal.
La douille XZN (triple carré) a une forme différente.

ST4027-140		D (mm)	H (mm)	L (mm)	(g)	(pcs.)
ST4027-140	1/2"	23	103.5	140	155	10



Head bolt Bit Socket for VW/AUDI
ST4027-140 can not substitute with any RIBE Socket.

Kopfschraube Bit-Einsatz für VW/AUDI
ST4027-140 kann nicht mit anderen RIBE-Einsätzen ersetzt werden.

Douille pour boulon à tête pour VW/AUDI
ST4027-140 ne peut être remplacé par aucune douille RIBE.

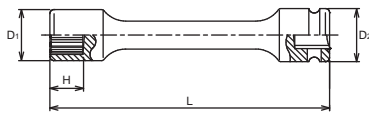

13145M-150 (12P) (mm)		D ₁ (mm)	D ₂ (mm)	H (mm)	L (mm)	(g)	(pcs.)	
10	3/8"	15.8	19	10	150	120	1	*1
12		18.3	19	12	150	128	1	*1

*1 C-Ring=C31, Pin/O-Ring=A31/B31 → P268-269

16305M (mm)		D ₁ (mm)	D ₂ (mm)	H ₁ (mm)	H ₂ (mm)	L (mm)	(g)	(pcs.)	
14	3/4"	26.3	44	14	74	100	500	2	*1
17		30	44	17	74	100	544	2	*1
19		32.5	44	19	74	100	655	2	*1
22		36.3	44	22	74	100	700	2	*1

*1 C-Ring=C61, Pin/O-Ring=A61/B61 → P268-269

4300H Oil Pressure Switch Sockets
Steckschlüssel für Öldruckschalter
Douilles pour interrupteur, pression d'huile

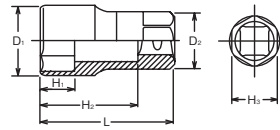

4300H (8P) 8-point Sockets
8-kant Steckschlüssel
Douilles 8-pans

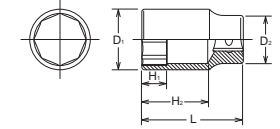

4010M-100 / -120 (12P) Bit Sockets for Double Inhex Screws (12-point)
Steckschlüssel für Innenzwölfkant-Schrauben
Douilles à 6-pans doubles

Bit Sockets for Double Inhex Screws (12-point)
Steckschlüssel für Innenzwölfkant-Schrauben
Douilles à 6-pans doubles

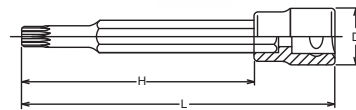

ST4027-140 Head Bolt Bit Socket for VW/AUDI
Bit Steckschlüssel für Zylinderkopfschrauben VW/AUDI
Douilles tournevis spéciales pour boulons de culasse VW/AUDI

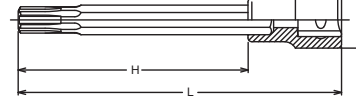

13145M-150 / -200 (12P) Extra Long Sockets
Schaftsteckschlüssel
Douilles, série allongée



13145M-200 (12P) (mm)		D ₁ (mm)	D ₂ (mm)	H (mm)	L (mm)	(g)	(pcs.)	
10	3/8"	15.8	19	10	200	151	1	*1
12		18.3	19	12	200	159	1	*1

16305M 12-point Sockets, deep
12-kant Steckschlüssel, lang
Douilles longues, 12-pans

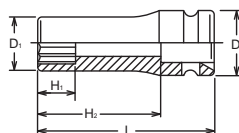

Z-SERIES
 HAND
 TITANIUM
 ACCESSORIES
 SCREWDRIVERS
 IMPACT
 SLEEVE-DRIVE
 PROTECTOR
 INDUSTRIAL
 AUTOMOTIVE
 MOTORCYCLE
 CONSTRUCTION
 SPARE PART

4109M  Double 4-point Sockets
 Doppelvierkant Steckschlüssel
 Douilles 4-pans, doubles

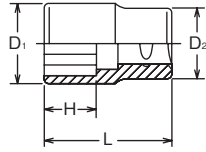

4109M (mm)		D ₁ (mm)	D ₂ (mm)	H (mm)	L (mm)	(g)	(pcs.)
14	1/2"	26.8	26	11	38	110	10
17		30	28	12.5	40	140	10
19		31.5	29	14	40	150	10
21.5		35	32	16	40	170	10
23		37	34	16.5	43	180	10

4109M series
 For Lubrication service

4111M  6-point Sockets
 6-kant Steckschlüssel
 Douilles 6-pans

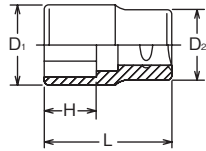

4111M (mm)		D ₁ (mm)	D ₂ (mm)	H (mm)	L (mm)	(g)	(pcs.)
24	1/2"	32	30	17	40	133	10

4111M
 For Lubrication service

4020-60 (MH)  Bit Socket for Triple Square with hole
 Steckschlüssel für XZN-Schrauben mit Loch
 Douilles tournevis avec trou pour empreinte XZN

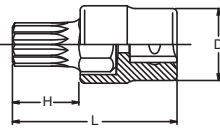



4020-60 (XZN)		D (mm)	H (mm)	L (mm)	(g)	(pcs.)
MH16	1/2"	24	20	60	135	10

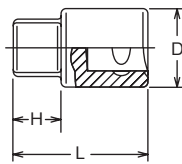

4020-60-MH16
 Specially designed for oil drain plug on gearbox of AUDI, VW, PORSCHE.

3110M / 3110A  4-point Male Sockets
 Öldienst-Steckschlüssel
 Douilles mâles 4-pans



3110M (mm)		D (mm)	H (mm)	L (mm)	(g)	(pcs.)
6	3/8"	18	10	28	30	10
8		18	10	28	30	10
10		18	10	28	33	10
12		18	10	28	37	10

3110A (inch)		D (mm)	H (mm)	L (mm)	(g)	(pcs.)
5/16	3/8"	18	10	28	30	10
3/8		18	10	28	33	10
1/2		18	10	28	37	10

3110MGH  4-point Male Sockets
 Öldienst-Steckschlüssel
 Douilles mâles 4-pans

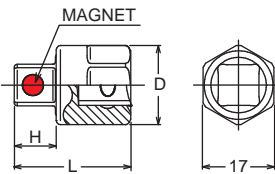

3110MGH (mm)		D (mm)	H (mm)	L (mm)	(g)	(pcs.)
8	3/8"	19	10	28	31	10
10		19	10	28	33	10

4110M / 4110A  4-point Male Sockets
 Öldienst-Steckschlüssel, Vierkant
 Douilles mâles 4-pans

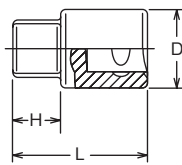



4110M (mm)		D (mm)	H (mm)	L (mm)	(g)	(pcs.)
8	1/2"	24	10	32	57	10
10		24	10	32	62	10
10.5		24	10	32	64	10
12		24	10	32	64	10
13		24	10	32	66	10
13.5		24	10	32	67	10
14		24.2	10	32	68	10
19		25	15	37	101	10
20		26	15	37	114	10

4110A (inch)		D (mm)	H (mm)	L (mm)	(g)	(pcs.)
3/8	1/2"	24	10	32	62	10
1/2		24	10	32	64	10

158  For Lubrication Service
Schmierdienst-Werkzeuge
Service lubrification-vidange



158 (mm)	L ₁ (mm)	L ₂ (mm)	d (mm)	 (g)	 (pcs.)
8Sx10S	63	230	13	319	1

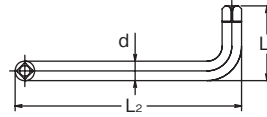

3012M-25 (mm)		D (mm)	L (mm)	 (g)	 (pcs.)
14	3/8"	19	25	30	10
17		19	25	30	10

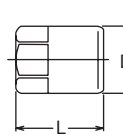

3012M-25  Inhex Sockets
Steckschlüssel für Innensechskant-Schrauben
Douilles tournevis pour vis 6-pans creux



4202 7 Pieces Set/ =426g



METAL CASE:W190xH59xT45mm



Sockets

-   **106 Drain Plug Keys**
8Sx10S, 8Hx3/8H, 10Hx11H, 12Hx13H, 14Hx17H, 19H
-  **4102 Drain Plug Key Adaptor**

4202 Drain Plug Keys Set
Öldienst-Satz
Jeu d'embouts pour le montage et démontage des bouchons de vidange



106 (mm)	H ₁ (mm)	H ₂ (mm)	H ₃ (mm)	L (mm)	 (g)	 (pcs.)
8Sx10S	8	8	17	32	40	10
8Hx3/8H	8	8	17	32	38	10
10Hx11H	8	8	17	32	42	10
12Hx13H	8	8	17	32	47	10
14Hx17H	8	8	17	32	55	10
19H	-	8	17	24	49	10

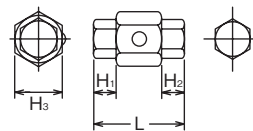

106   4-point / 6-point Male bits
Innenvierkant / Innensechskantsteckschlüssel
Embouts mâles 4-pans / 6-pans

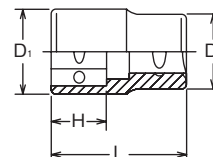

4102 (mm)		D ₁ (mm)	D ₂ (mm)	H (mm)	L (mm)	 (g)	 (pcs.)
17	1/2"	25	24	16	40	82	10

4102  Adaptor for 106 Drain plug key
Halter für Öldienst-Einsätze 106
Porte embouts pour 106



3400M-24 (mm)		D ₁ (mm)	D ₂ (mm)	H (mm)	L (mm)	 (g)	 (pcs.)
27	3/8"	36.5	21.5	13.5	24	76	10
30		40	25	13.5	24	91	10
32		42.8	28	13.5	24	108	10
36		47.2	32	13.5	24	135	10

3400M-24  Extra short 6-point Sockets for Oil-Filter Service
Extra kurze Steckschlüssel für Ölfilter
Douille extra courte pour filtre à huile

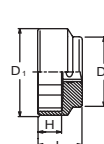

Z-SERIES
 HAND
 TITANIUM
 SCREWDRIVERS ACCESSORIES
 IMPACT
 SLEEVE-DRIVE
 PROTECTOR
 INDUSTRIAL
 AUTOMOTIVE
 CONSTRUCTION MOTORCYCLE
 SPARE PART

1206  Push and Pull-Ratchet
 Hub Knarre
 Clé à cliquet de levage



154K  Push and Pull-Ratchets
 Hub Knarre
 Clé à cliquet de levage



150-14H  Socket, For 154K
 Einsätze für 154K
 Douilles pour 154K



1210E Door Hinge Wrench Set
 Montagesatz für Kfz-Türscharniere
 Jeux d'outils spéciaux pour charnières de portes



145KD Special ratchet for 179B-12H insert bits
 Spezialknarre zur Aufnahme von 179B-12H Einsatzbits
 Cliquet spécial pour recevoir les embouts d'insertion 179B-12H



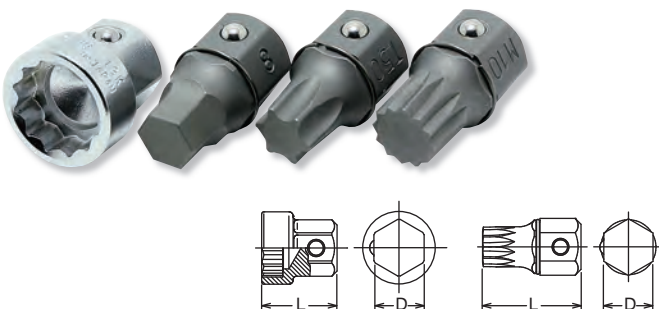

179B-12H Insert bit for the 145KD ratchet
 Einsatz-Bit für die Knarre 145KD
 Embout d'insertion pour cliquet 145KD



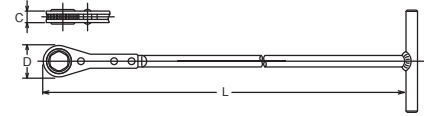

1206 3 Pieces Set/△=320g





CARDBOARD BOX	
Sockets	Accessory
 150.14H Sockets 12, 14	154K-14





154K (mm)	L (mm)	D (mm)	C (mm)	 (g)	 (pce.)
14	480	24.6	9	280	1





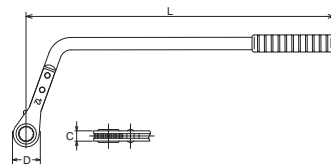

150-14H (mm)	D (mm)	H (mm)	L (mm)	 (g)	 (pce.)
10	16	5	17	16	10
12	17.3	5	18	14	10
14	19.2	7	21	17	10

1210E 11 Pieces Set/△=460g

PLASTIC BAG	
Sockets	Accessory
 179B.12H Sockets 10, 12, 13	145KD-12
 179B.12H XZN Bits M8, M10, M12	
 179B.12H TORX® Bits T40, T45, T50	
 179B.12H Hex Bit 8	



145KD	D (mm)	C (mm)	L (mm)	 (g)	 (pce.)
12	24	9	280	274	1

179B.12H	Type	D (mm)	L (mm)	 (g)	 (pce.)
10		12	18	15	10
12		18	17	10	
13		18	18	10	
7H		12	24	17	10
8H		24	18	10	
M6		12	24	14	10
M8		24	15	10	
M10		24	17	10	
M12		12	24	20	10
T40		24	14	10	
T45		24	15	10	
T50		12	24	16	10

Z-SERIES
HAND
TITANIUM
ACCESSORIES
SCREWDRIVERS
IMPACT
SLEEVE-DRIVE
PROTECTOR
INDUSTRIAL
AUTOMOTIVE
MOTORCYCLE
CONSTRUCTION
SPARE PART

145LH3/8F (LH-S)		L (mm)	D (mm)	C (mm)	 (g)	 (pcs.)
10S	3/8"	100	25	15.5	90	10

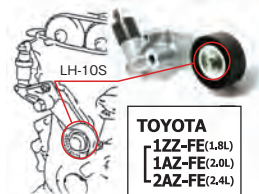

Belt Tension Pulley Wrench
For LH-10S bolt on TOYOTA engines 1ZZ (1.8L), 1AZ (2.0L) and 2AZ (2.4L), belt tension pulley.

TOYOTA
1ZZ-FE(1.8L)
1AZ-FE(2.0L)
2AZ-FE(2.4L)

This item has less strength due to the special design.

145LH3/8F

Belt Tension Pulley Wrench
Knarren-Ringschlüssel für Riemen-Spannrolle
Clé multicrân à cliquet pour galet-tendeur

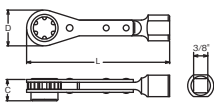

4282 4 Pieces Set/△=449g

PLASTIC BAG

Sockets

	1/2"	4020.100-M10 4020.140-M10
	1/2"	4025.100R-T50
		185



Generator Service Set
For removing and installing belt pulley at the generator.

Generator-Service-Set
Zum Aus- und Einbau der Riemenscheibe am Generator.

Kit d'entretien du générateur
Pour enlever et installer la poulie de la courroie sur le générateur.

4282

1/2" Sq.Dr. Generator Service Set
1/2" Lichtmaschinen-Service Satz
Jeu 1/2" pour l'entretien des générateurs électriques



3247 4 Pieces Set/△=385g

PLASTIC BAG

Sockets

	3/8"	3025.160 Tamper-resistant TORX® Bit Sockets T27H, T30H, T40H, T50H
--	------	---

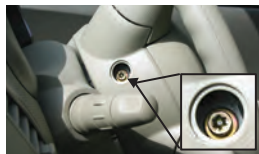

For Air Bag
For air-bag unit in hard to reach places in or around the steering wheel.

Für Airbag-Einheiten an schwer zugänglichen Stellen im oder um das Lenkrad.

Pour l'unité airbag dans les endroits difficiles d'accès à l'intérieur ou autour du volant.

3247

Bit Socket Set
Schraubendreher-Steckschlüssel Satz
Jeu de douilles de vissage



Tamper resistant TORX® Bits have less strength due to special design. Make sure to use it correctly.

Die manipulationssicheren TORX®-Bits haben aufgrund ihres speziellen Designs eine geringere Festigkeit. Achten Sie darauf, sie richtig zu verwenden.

Les embouts TORX®, à l'abri de manipulations, sont moins résistants en raison de leur conception spéciale. Veuillez les utiliser correctement.

3300M/4-L120 4 Pieces Set/△=477g

PLASTIC BAG

Sockets

	3/8"	3300M(L120) 6-pt. Extra Deep Sockets 8, 10, 12, 14
--	------	---

Extra Deep Socket

Extra Deep socket can be used to fasten or loosen longer bolts such as Bumper bolt and Door Hinge etc.

Die extra tiefe Stecknuss kann zum Befestigen oder Lösen von längeren Schrauben wie Stoßstangenbolzen und Türscharnieren usw. verwendet werden.

La douille extra profonde peut être utilisée pour fixer ou desserrer des boulons plus longs tels que les boulons de pare-chocs et les charnières de porte, etc.



BUMPER BOLT



DOOR HINGE



DEEP SOCKET



EXTRA DEEP SOCKET

3300M/4-L120

Socket Set
Steckschlüssel Satz
Jeu de clés à douille



3350M/2-L120 2 Pieces Set/△=230g

PLASTIC BAG

Sockets

	3/8"	3350M(L120) Nut Grip Extra Deep Sockets 10, 12
--	------	---

Nut Grip Extra Deep Socket

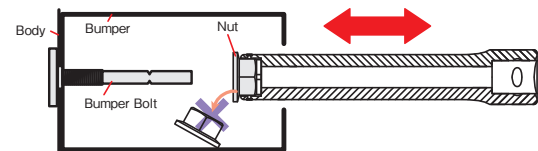

NUT GRIP®

3350M/2-L120

Socket Set
Steckschlüssel Satz
Jeu de clés à douille



TORX is a registered trademark of CAMCAR Innovations.
TORX ist ein registriertes Markenzeichen der Firma CAMCAR Innovations.
TORX est une marque déposée de CAMCAR Innovations.

OSG is a registered trademark of OSG SYSTEM PRODUCTS CO., LTD.
OSG ist ein registriertes Markenzeichen der Firma OSG SYSTEM PRODUCTS CO., LTD.
OSG est une marque déposée de OSG SYSTEM PRODUCTS CO., LTD.

Z-SERIES
 HAND
 TITANIUM
 ACCESSORIES
 SCREWDRIVERS
 IMPACT
 SLEEVE-DRIVE
 PROTECTOR
 INDUSTRIAL
 AUTOMOTIVE
 MOTORCYCLE
 CONSTRUCTION
 SPARE PART

1212 Long shank Screwdriver 4 pieces set
 Extra lange Schraubendreher 4teiliger Satz
 Tournevis longs. Jeu de 4 pièces



168T (250) Extra long shank Screwdrivers
 Extra lange Schraubendreher
 Tournevis extra longs

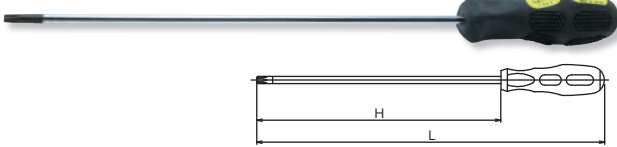

169/2 Door Trim Pad Tool, 2 pieces set
 Demontagehebel für Türclips, Satz 2-teilig
 Jeu, levier pour le démontage des garnitures de portes

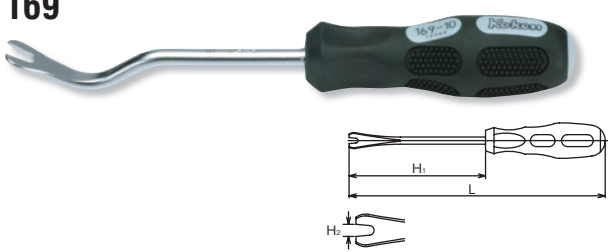

169WM Window Molding Remover
 Zum Lösen von Fenstergummis
 Pour le démontage des joints de vitres



169HR/2 Hose Remover, 2 pieces set
 Universalhaken, 2teiliger Satz
 Pour le démontage des tuyaux. Jeu de 2 pièces

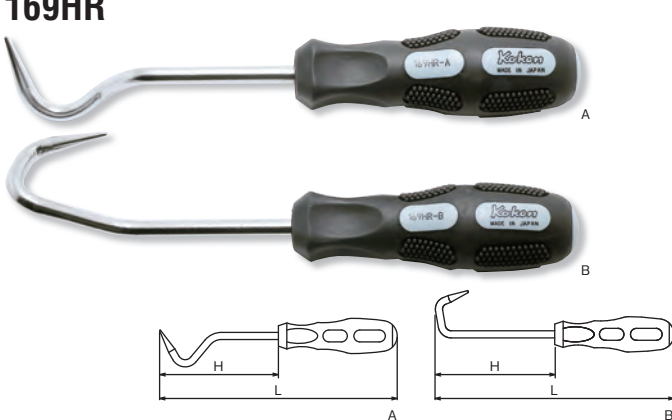

169BP For Battery Screws
 Für Batterie-Verschlussstopfen
 Pour vis de batterie



1212 4 Pieces Set/⚖️=380g
 PLASTIC BAG

Screwdrivers				
168T(250) 20IPR				
168T(250) T20, T25, T30				



Long shank Screwdriver
 Schraubendreher mit langem Schaft
 Tournevis à tige longue

168T(250) (IPR)	H (mm)	L (mm)	(g)	(pcs.)
20IPR	250	350	85	1
168T(250) (T)	H (mm)	L (mm)	(g)	(pcs.)
T20	250	350	85	1
T25	250	350	85	1
T30	250	360	120	1

169/2 2 Pieces Set/⚖️=200g
 PLASTIC BAG

Clip Handles				
169				
6, 10				

169	H ₁ (mm)	H ₂ (mm)	L (mm)	(g)	(pcs.)
6	115	5	215	80	2
10	120	9	230	110	2



Handle for Door trim pads
 Handgriff für Türverkleidungen
 Poignée pour garnitures de porte

169WM	H (mm)	L (mm)	(g)	(pcs.)
169WM	100	210	90	2

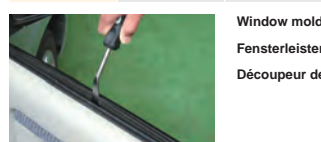

Window molding remover
 Fensterleistenentferner
 Découpeur des joints fenêtres

169HR/2 2 Pieces Set/⚖️=180g
 PLASTIC BAG

Hose Remover				
169HR				
A, B				

169HR	H (mm)	L (mm)	(g)	(pcs.)
A	100	200	75	2
B	100	200	90	2



Hose remover
 Schlauchentferner
 Démonte-tuyau

169BP	TxW (mm)	H (mm)	L (mm)	(g)	(pcs.)
1.8x13	1.8x13	50	150	60	2

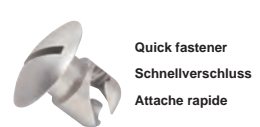

For Battery screw

Quick fastener
 Schnellverschluss
 Attache rapide

4425 (E)		D ₁ (mm)	D ₂ (mm)	H (mm)	L (mm)	(g)	(pcs.)
E10N	1/2"	13.2	21	8.2	36	47	10
E12N		14.6	21	9.3	37	48	10
E14N		16.5	21	10.6	37	50	10
E16N		19	22	11.8	37	60	10
E18N		20.3	22	13	37	60	10
E20N		22.8	22	14.4	37	65	10

RS4425/6-N	6 Pieces Set/Rail 200mm	(g)
E10N, E12N, E14N, E16N, E18N, E20N		370



Engine type: QR/MR
Flywheel bolt for NISSAN: E20
Motortyp: QR/MR
Schwungradschraube für NISSAN: E20
Type de moteur : QR/MR
Vis de volant moteur pour NISSAN: E20

13145A.150 (inch)		D ₁ (mm)	D ₂ (mm)	H (mm)	L (mm)	(g)	(pcs.)	
9/16(D20)	3/8"	20	19	13	150	130	5	*1

*1 C-Ring=C31, Pin/O-Ring=A31/B31 → P268-269

14145A.150 (inch)		D ₁ (mm)	D ₂ (mm)	H (mm)	L (mm)	(g)	(pcs.)	
9/16(D20)	1/2"	20	25	13	150	200	5	*1

*1 C-Ring=C41, Pin/O-Ring=A41/B41 → P268-269

For Land Rover Prop Shaft

		D ₁ (mm)	D ₂ (mm)	L (mm)	(g)	(pcs.)	
13772-B	3/8"	22	19	75	120	5	*1
13772-P		22	19	75	120	5	*1
14772-B	1/2"	27	25	90	230	1	*2
14772-P		27	25	90	230	1	*2

*1 C-Ring=C31, Pin/O-Ring=A31/B31

*2 C-Ring=C41, Pin/O-Ring=A41/B41



13772 and 14772 have less load capacity than standard. In the interest of your safety always use properly.

Die Doppelgelenke 13772 und 14772 haben eine geringere Belastbarkeit als das Standardgelenk. Im Interesse Ihrer Sicherheit sollten Sie sie immer richtig verwenden.

Les doubles articulations 13772 et 14772 ont une capacité de charge inférieure à celle de l'articulation standard.

Dans l'intérêt de votre sécurité, veuillez les utiliser correctement.

14305M (mm)		D ₁ (mm)	D ₂ (mm)	H ₁ (mm)	H ₂ (mm)	L (mm)	(g)	(pcs.)	
30	1/2"	42	30	30	63	85	457	10	*2
32		44.5	30	32	63	85	542	10	*2
36		49.5	30	36	61	85	635	2	*2

*2 C-Ring=C42, Pin/O-Ring=A42/B42 → P268-269



4101		TxW (mm)	D (mm)	L (mm)	(g)	(pcs.)
1	1/2"	2.7x18.6	22	40	59	10
2		3.7x24	24	40	79	10
3		3.7x30	30	40	128	10

6101		TxW (mm)	D (mm)	L (mm)	(g)	(pcs.)
6101	3/4"	6.4x33.5	35	50	205	5

4425-N

TORX® Sockets
TORX® Steckschlüssel
Douilles TORX®

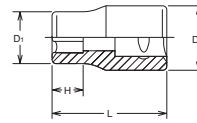

RS4425/6-N

Socket Set on Rail
Steckschlüsselsatz auf Schiene
Jeu de douilles sur rail



13145A-150

Extra Long Socket
Schaftsteckschlüssel
Douilles, série allongée

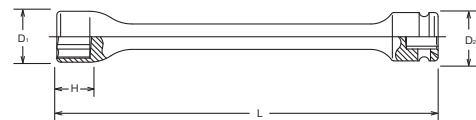

13772

Universal Double Joint
Doppelgelenk-Einsatz
Joint articulé double

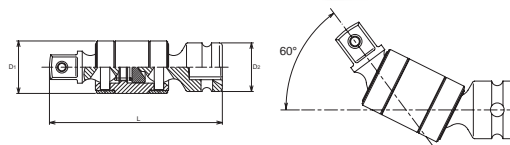

14305M

12-point Deep Sockets
12-kant Steckschlüssel, lang
Douilles longues 12-pans

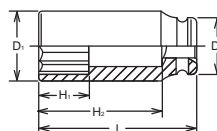

4101

Sockets for Slotted Heads
Steckschlüssel für Schlitzschrauben
Douilles tournevis pour vis à fente

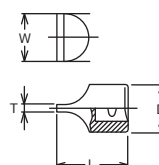

Z-SERIES
 HAND
 TITANIUM
 SCREWDRIVERS ACCESSORIES
 IMPACT
 SLEEVE-DRIVE
 PROTECTOR
 INDUSTRIAL
 AUTOMOTIVE
 MOTORCYCLE
 CONSTRUCTION
 SPARE PART

4300M (L60)



Wheel Nut Sockets
 Radmuttern Steckschlüssel
 Douilles pour écrous de roue

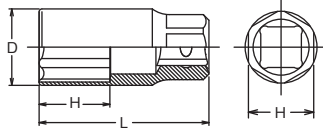

4300M(L60) (mm)		D (mm)	H (mm)	L (mm)	H (mm)	 (g)	 (pcs.)
17	1/2"	23.8	25	60	21	98	10
19		25.8	25	60	21	100	10
21		27.6	25	60	21	102	10



Wheel Nut Sockets



Please note that thin walled design is only for wheel nut work and Torque rating is limited.

4300M (L110)



Wheel Nut Sockets (Long)
 Radmuttern-Steckschlüssel, extra lang
 Douilles extra longues pour écrous de roue

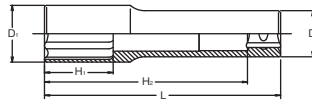

4300M(L110) (mm)		D ₁ (mm)	D ₂ (mm)	H ₁ (mm)	H ₂ (mm)	L (mm)	 (g)	 (pcs.)
17	1/2"	23.8	22	32	93	110	155	5
19		25.8	22	32	93	110	170	5
21		27.6	22	32	93	110	165	5
New 22		29.1	22	32	93	110	165	5



Please note that thin walled design is only for wheel nut work and Torque rating is limited.

4711X



Spinning cross wrench
 T-Griff für die Radmuttermontage
 Poignée coulissante pour montage des écrous à roue

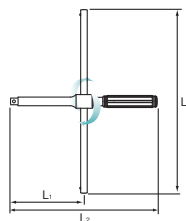

FREE-TURN
 CROSS WRENCH

4711X		L ₁ (mm)	L ₂ (mm)	L ₃ (mm)	 (g)	 (pce.)
4711X	1/2"	140	280	350	945	1

14201M 3 Pieces Set/△=690g
CARDBOARD BOX:W125xH95xT34mm

Sockets
14145PM.110 Impact Wheel Nut Sockets
17, 19, 21

14145PM-110 (mm)		D ₁ (mm)	D ₂ (mm)	H (mm)	Shaft Colour	(g)	(pcs.)	
17		23.8	25.2	21	Blue	208	5	*1
19	1/2"	25.8	27.2	23	Red	219	5	*1
21		27.6	29	25	Yellow	226	5	*1
22		29	30.5	26	White	238	5	*1

*1 C-Ring=C41, Pin/O-Ring=A41/B41 → P268-269



**PLASTIC PROTECTOR
KUNSTSTOFF HÜLSE
PROTECTION EN PLASTIQUE**

A detachable plastic protector is fitted to the socket to prevent damage to the wheel when working in tight areas. The socket size and Ko-ken mark printed on the shaft makes it easier to see if the socket is still rotating or stopped.

Zum Schutz empfindlicher Leichtmetallfelgen ist eine drehbare und abnehmbare Kunststoff Hülse an dem Steckschlüssel montiert. Die aufgedruckten Markierungen am Werkzeugschaft zeigen außerdem ob das Werkzeug steht oder rotiert.

La douille est pourvue d'un insert en plastique détachable. Il sert à prévenir tout dommage aux jantes lors de l'utilisation des douilles.

Le marquage sur la tige rend l'identification des douilles très facile.

198-17 : Spare Plastic Protector for 14145PM.110-17 : 10 pcs.
198-19 : Spare Plastic Protector for 14145PM.110-19 : 10 pcs. 280PM-19
198-21 : Spare Plastic Protector for 14145PM.110-21 : 10 pcs. 280PM-21
198-22 : Spare Plastic Protector for 14145PM.110-22 : 10 pcs.

⚠ Please note that thin walled design is only for wheel nut work and Torque rating is limited.

14145M-110 (mm)		D ₁ (mm)	D ₂ (mm)	H (mm)	(g)	(pcs.)
17MB	1/2"	25.7	27.2	11.5	256	5



Mercedes Benz Wheel Bolt
Mercedes Benz Radbolzen
Boulon de roue Mercedes Benz

New P14145M/5 5 Pieces Set/△=1530g

CARDBOARD BOX:W230xH200xT70mm

Sockets
14145PM.110 Impact Wheel Nut Socket
17, 19, 21, 22
14145M.110 Impact Wheel Bolt Socket
17MB



14201M
14145PM-110

Wheel Nut Sockets Set
Radmuttern Steckschlüssel im Satz
Douilles pour écrous de roue
Wheel Nut Sockets
Radmuttern Steckschlüssel
Douilles pour écrous de roue

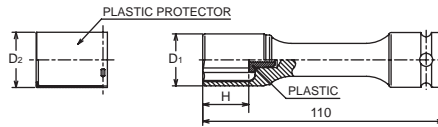

**EXTRA THIN WALL
EXTRA DÜNNWANDIG
PAROIS EXTRA MINCES**

Special design for wheel nut work.

-110mm length gives socket extra reach for nuts recessed deep inside the wheel and ideal for Aluminum wheel nuts where access to nut is very tight.
-Blue(17mm), Red(19mm), Yellow(21mm) and White(22mm) colour coded shafts make size identification easy.
-Plastic insert helps prevent damaged to wheel nut.

Speziell entwickelt für die Montage von Radmuttern

- Die Länge von 110mm erlaubt es mit diesem Steckschlüssel auch extra tiefe Radmuttern zu erreichen.
- Dieser Steckschlüssel ist ideal für Radmuttern von Aluminiumfelgen, da gerade dort der Platz zwischen Schraube und Felge äußerst gering ist.
- Durch die farbige Markierung; blau(17mm), Rot(19mm), Gelb(21mm) und Weiß(22mm) wird die Erkennung des passenden Werkzeugs erleichtert.
- Der Plastikanschlag schützt die Radmutter vor Beschädigungen.

Douilles spécialement conçues pour les écrous de roue :

- La longueur de 110mm permet d'atteindre les écrous enfoncés profondément.
- Idéales pour les écrous des jantes en aluminium où le passage est souvent étroit
- Les corps de couleurs différentes facilitent l'identification : bleu (17mm), rouge (19mm), jaune (21mm) et blanc (22mm)
- Les inserts en plastique évitent de détériorer les jantes.

14145M-110MB

Mercedes Benz Wheel Bolt
Mercedes Benz Radbolzen
Boulon de roue Mercedes Benz

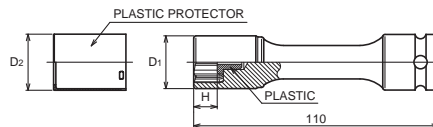

P14145M/5

5 pieces Wheel Nut Sockets Set in Plastic case
Radmuttern-Steckschlüssel-Satz 5teilig im Kunststoffkoffer
Jeu de 5 douilles pour écrous de roue dans un coffret en plastique



Z-SERIES
 HAND
 TITANIUM
 SCREWDRIVERS ACCESSORIES
 IMPACT
 SLEEVE-DRIVE
 PROTECTOR
 INDUSTRIAL
 AUTOMOTIVE
 MOTORCYCLE
 CONSTRUCTION
 SPARE PART

280PM Adaptor Socket for Low Profile Wheel Nut
 Adapter Steckschlüssel für kurze Radmutter
 Adapteur pour des écrous de roue courts



280PM (mm)	D ₁ (mm)	D ₂ (mm)	H ₁ (mm)	H ₂ (mm)	L (mm)	Shaft Colour	(g)	(pcs.)
19	25.8	27.2	13	19	52	Red	150	5
21	27.6	29	13	21	55	Yellow	180	5

Designed for Low Profile Wheel nut socket.
 Detachable plastic protector is fitted to the adaptor to prevent damage to painted or surface treatment area on the wheel.
 The Plastic insert locate inside of the adaptor prevents damage to wheel nut.
 Colour coded band make size identification easy.

Die abnehmbare Kunststoffhülse schützt die Felge vor Kratzern oder Schrammen an der empfindlichen Oberfläche.
 Der Kunststoffanschlag im inneren des Werkzeugs schützt zusätzlich die Radmutter.
 Die Farbmarkierung macht die Identifikation des Werkzeugs einfach.

La protection plastifiée amovible, protège la jante et évite des endommagements sur des surfaces délicates.
 Le plastic inséré à l'intérieur de l'outil protège également l'écrou de roue.
 L'identification de l'outil est simplifiée par le marquage en couleur.

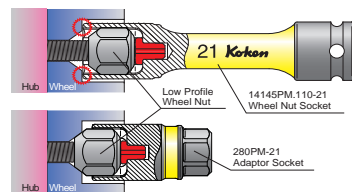
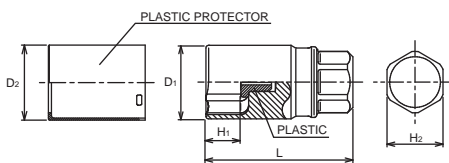

14118M Wheel Nut Sockets, Double Ended
 Radmutter Steckschlüssel, doppelseitig
 Douilles pour écrous de roue à ouvertures doubles

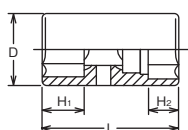

14118M (mm)	D (mm)	H ₁ (mm)	H ₂ (mm)	L (mm)	(g)	(pcs.)
17x19	28	15.5	13	48	150	10
19x21	31	17.5	13	57	177	10
19x22	31	17.5	15	57	187	10

14218M		2 Pieces Set/△=360g	
CARDBOARD BOX			
Sockets		Accessory	
1/2"	14118PM 19x21		14760ST-B

Interchangeable Wheel Nut Socket of 19mm and 21mm.
 ⚠ Please note that thin walled design is only for wheel nut work and Torque rating is limited.
 Socket is not completely locked with the Ball-type connection.
 Please beware of accidental socket release.

14218M Wheel Nut Sockets, Double Ended with Extension Bar
 Radmutter Steckschlüssel, doppelseitig, mit Verlängerung
 Douille pour écrous de roue à ouvertures double plus rallonge



New 14219M		3 Pieces Set/△=620g	
CARDBOARD BOX			
Sockets		Accessory	
1/2"	14118M 18.5x19.5SV, 20.5x21.5SV		14760-100B

⚠ For loosening the chrome-plated or deformed original wheel nut from FORD, GM and Chrysler. The chrome-plated cover of the wheel nut can become deformed when trying to loosen it, so that a 19 mm loosening spanner can no longer be fitted and removed accurately. The 18.5 and 19.5 mm release tool can be applied to chipped chrome covers and damaged cap nuts in such a way that the damaged wheel nut can be safely released. The 1/2" impact extension enables the use of an impact wrench.
 Zum Lösen der verchromten oder deformierten Original-Radmutter von FORD, GM und Chrysler. Der verchromte Deckel der Radmutter kann sich beim Lösen verformen, so dass ein 19-mm-Löseschlüssel nicht mehr exakt angesetzt und entfernt werden kann. Das 18,5- und 19,5-mm-Löseschlüssel kann bei abgeplatzten Chromabdeckungen und beschädigten Hutmutter so angesetzt werden, dass die beschädigte Radmutter sicher gelöst werden kann. Die 1/2"-Schlagverlängerung ermöglicht die Verwendung eines Schlagschraubers.

Pour desserrer l'écrou de roue d'origine chromé ou déformé de FORD, GM et Chrysler. Le couvercle chromé de l'écrou de roue peut se déformer lorsqu'on essaie de le desserrer, de sorte qu'une clé de 19 mm ne peut plus être montée et retirée avec précision. L'outil de déblocage de 18,5 et 19,5 mm peut être appliqué aux couvercles chromés ébréchés et aux écrous borgnes endommagés de manière à ce que l'écrou de roue endommagé puisse être débloqué en toute sécurité. La rallonge à percussion 1/2" permet d'utiliser une clé à percussion.

14219M Special wheel nut loosening tool, set of 3
 Spezial Radmutter Lösewerkzeug, Satz 3teilig
 Outil spécial de desserrage d'écrous de roue, jeu de 3



AN14300 Impact Sockets, Aluminium alloyed, for aluminium wheel nuts
 Aluminium-legierte Impact Steckschlüssel für Aluminium Radmutter
 Douilles Impact en aluminium pour écrous de roue aluminium

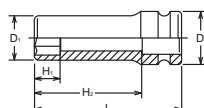

AN14300 (mm)	D ₁ (mm)	D ₂ (mm)	H ₁ (mm)	H ₂ (mm)	L (mm)	(g)	(pcs.)	⚡
17	25.7	30	17	62	80	85	10	*1
19	28.2	30	19	61	80	89	10	*1
21	30.7	30	21	61	80	93	10	*1

*1 C-Ring=C42, Pin/O-Ring=A42/B42 → P268-269

Z-SERIES
HAND
TITANIUM
ACCESSORIES
SCREWDRIVERS
IMPACT
SLEEVE-DRIVE
PROTECTOR
INDUSTRIAL
AUTOMOTIVE
MOTORCYCLE
CONSTRUCTION
SPARE PART

14113J (mm)		D ₁ (mm)	D ₂ (mm)	H (mm)	L (mm)	 (g)	 (pcs.)	
17	1/2"	25.7	30	14	80	251	10	*1
19		28.2	30	16	80	286	10	*1
21		30.7	30	20	80	309	10	*1

*1 C-Ring=C42, Pin/O-Ring=A42/B42 → P268-269

14113M (mm)		D ₁ (mm)	D ₂ (mm)	H (mm)	L (mm)	 (g)	 (pcs.)	
17	1/2"	25.7	30	34	80	230	10	*1
19		28.2	30	38	80	262	10	*1
21		30.7	30	42	80	285	10	*1

*1 C-Ring=C42, Pin/O-Ring=A42/B42 → P268-269

14124 (mm)		D ₁ (mm)	D ₂ (mm)	H ₁ (mm)	H ₂ (mm)	L (mm)	 (g)	 (pcs.)
21x24.5	1/2"	28	29.5	24	25	65	157	10
26x27.5		31.5	35	24.5	24.5	65	197	10

14124/3		3 Pieces Set/=580g	
CARDBOARD BOX:W125xH91xT43mm			
Sockets		Accessory	
	14124 21x24.5 26x27.5		14760-75B



14113J

Impact Sockets with Plastic Stops for Hub Cap Screws
Impact Steckschlüssel mit Plastik-Anschlag für Zier-Radmuttern
Douilles Impact avec arrêt en plastique, pour écrous de roue décoratifs

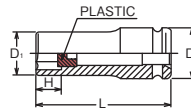

14113M

For Hub Cap Screws
Für Zier-Radmuttern
Pour écrous de roue décoratifs

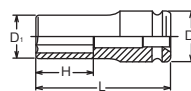

14124

Lock Nut Busters (Double Ended)
Felgenschloss-Knacker, doppelseitig
Douilles taraudées à ouvertures doubles pour dévisser les écrous ou goujons de roue antivols.

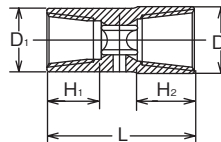

14124/3

Lock Nut Busters (Double Ended) in Set
Felgenschloss-Knacker, doppelseitig im Satz
Jeu de douilles taraudées à ouvertures doubles pour dévisser les écrous ou goujons de roue antivols.



14124

Lock Nut Busters
Felgenschloss-Knacker
Douilles taraudées pour dévisser les écrous ou goujons de roue antivols.

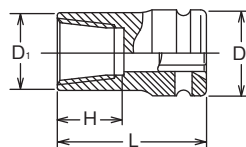

14124 (mm)		D ₁ (mm)	D ₂ (mm)	H (mm)	L (mm)	 (g)	 (pcs.)	
17	1/2"	20.5	25	15	50	83	10	*1
18		21	25	15	50	83	10	*1
18.5		23	25	15	50	95	10	*1
19		25	30	20.5	50	140	10	*2
21		28	30	20.5	50	153	10	*2
24.5		29.5	30	23	50	138	10	*2
26		31.5	30	23	50	147	10	*2
27.5		35	30	23	50	181	10	*2

*1 C-Ring=C41, Pin/O-Ring=A41/B41

*2 C-Ring=C42, Pin/O-Ring=A42/B42

→ P268-269



RS14124/7	7 Pieces Set/Rail 250mm	 (g)
18, 18.5, 19, 21, 24.5, 26, 27.5		980

RS14124/7

Socket Set on Rail
Steckschlüsselsatz auf Schiene
Jeu de douilles sur rail



Z-SERIES
 HAND
 TITANIUM
 ACCESSORIES
 SCREWDRIVERS
 IMPACT
 SLEEVE-DRIVE
 PROTECTOR
 INDUSTRIAL
 AUTOMOTIVE
 MOTORCYCLE
 CONSTRUCTION
 SPARE PART



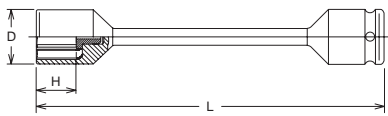
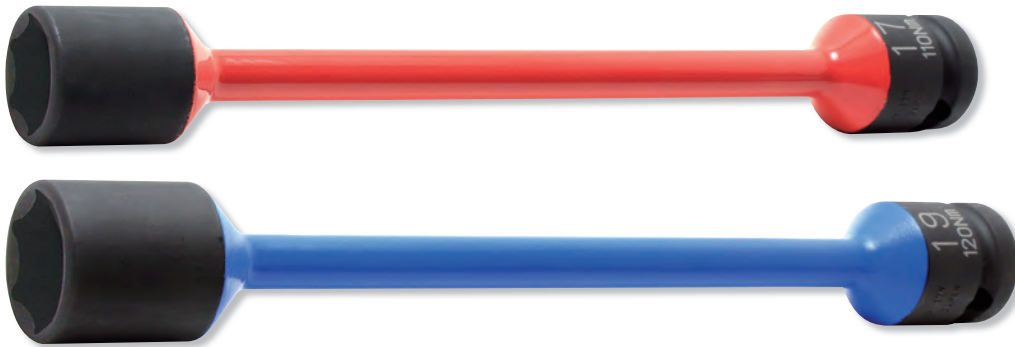

14101MP  Torsion Bars (for tightening only)
 Torsionsstäbe (nur zum Anziehen)
 Barres de torsion (pour serrage seulement) 



 As the torque could vary with the type and the condition of the impact wrench, we strongly recommend the control with a torque wrench.

Da die Drehmomentwerte von Art und Leistung des verwendeten Schlagschraubers abhängen, empfehlen wir die Kontrolle der Kombination Schlagschrauber/Torsionsstab mittels eines Drehmomentschlüssels.

Etant donné que le couple peut varier selon modèle, la capacité ou l'état de la clé à choc, le contrôle de la combinaison clé à choc/barre par clé dynamométrique est indispensable.

14101MP (mmxNm)		D (mm)	H (mm)	L (mm)	Shaft Colour	 (pcs.)	
17x 95Nm		25	16	214	Yellow	10	*1
17x110Nm		25	16	204	Red	10	*1
17x120Nm		25	16	203	Green	10	*1
19x 90Nm		27	18	259	Yellow	10	*1
19x100Nm		27	18	233	Blue	10	*1
19x120Nm		27	18	204	White	10	*1
19x140Nm		27	18	199	Orange	10	*1
21x100Nm		29	22	216	Black	10	*1
21x120Nm		29	22	205	Brown	10	*1
22x150Nm		30	22	220	Purple	10	*1

*1 C-Ring=C41, Pin/O-Ring=A41/B41 → P268-269

14101MP-M/8  Metal-Wall-Hanger for Workshops
 Werkstatt-Wandhänger (Metall)
 Support métallique d'atelier 



14101MP-M/8 8 Pieces Set/△=2,300g
 HANGER

Torsion Bar
14101MP Impact Torsion Bars
 17x95Nm, 17x110Nm, 17x120Nm,
 19x90Nm, 19x100Nm, 19x120Nm, 19x140Nm, 21x100Nm

Torque table included in delivery.

Drehmomenttabelle wird mitgeliefert.

Tableau des couples de serrage inclus dans la livraison.

Torsion Bars

- Designed for tightening wheel nuts with an impact wrench.
- Prevent the excessive torque road.
- Colour coded shafts make size identification easy.



Torsionsstäbe

- Zur Montage von Radmuttern mit dem Schlagschrauber.
- Schützt die Radmutter vor zu hohen Anzugsmomenten.
- Die Farbmarkierung erleichtert das Erkennen des passenden Werkzeugs.



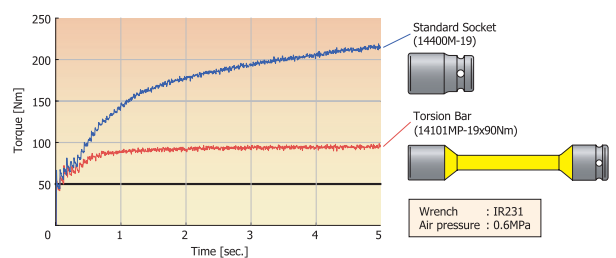

Barres de torsion

- Pour le montage d'écrou de roue avec visseuse à chocs.
- Protège l'écrou d'un serrage à couple excessif.
- La colorisation des barres facilite l'identification des tailles.

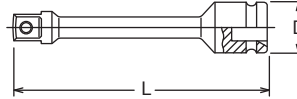



14112-P  Torsion Extension Bars (for tightening only)
Torsionsstab-Verlängerungen (nur zum Anziehen) 
Barres de torsion (pour serrage seulement)







14112-P (Nm)		D (mm)	L (mm)	 (g)	 (pce.)	
90Nm	1/2"	25	208	206	1	*1
95Nm		25	202	200	1	*1
100Nm		25	196	198	1	*1
110Nm		25	213	220	1	*1
120Nm		25	201	219	1	*1
130Nm		25	205	225	1	*1
140Nm		25	205	230	1	*1
150Nm		25	195	250	1	*1
170Nm	25	195	257	1	*1	

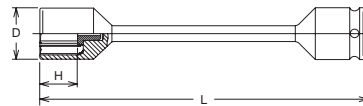

*1 C-Ring=C41, Pin/O-Ring=A41/B41 → P268-269

14101M  Torsion Bars (for tightening only)
Torsionsstäbe (nur zum Anziehen) 
Barres de torsion (pour serrage seulement)





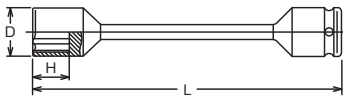

14101M (mmxNm)		D (mm)	H (mm)	L (mm)	 (g)	 (pce.)		
17x 60Nm	1/2"	25	16	216	227	1	*1	
17x 75Nm		25	16	228	240	1	*1	
17x 95Nm		25	16	214	256	1	*1	
17x110Nm		25	16	204	285	1	*1	
17x120Nm		25	16	203	284	1	*1	
17x140Nm		25	16	200	290	1	*1	
19x 60Nm		3/4"	27	18	219	237	1	*1
19x 90Nm			27	18	259	275	1	*1
19x110Nm			27	18	214	278	1	*1
19x120Nm			27	18	204	297	1	*1
19x135Nm			27	18	204	339	1	*1
19x170Nm			27	18	193	332	1	*1
21x100Nm	29		22	216	288	1	*1	
21x120Nm	29		22	205	288	1	*1	
22x160Nm	30	22	210	385	1	*1		

*1 C-Ring=C41, Pin/O-Ring=A41/B41 → P268-269

16101M  Torsion Bars (for tightening only)
18101M  Torsionsstäbe (nur zum Anziehen) 
Barres de torsion (pour serrage seulement)







16101M (mmxNm)		D (mm)	H (mm)	L (mm)	 (g)	 (pce.)	
24x180Nm	3/4"	38.8	24	235	850	1	*1
27x450Nm		42.5	27	280	1236	1	*1
32x600Nm		48.8	32	280	1370	1	*1
33x600Nm		50	33	280	1370	1	*1

*1 C-Ring=C61, Pin/O-Ring=A61/B61 → P268-269

 As the torque could vary with the type and the condition of the impact wrench, we strongly recommend the control with a torque wrench.

Da die Drehmomentwerte von Art und Leistung des verwendeten Schlagschraubers abhängen, empfehlen wir die Kontrolle der Kombination Schlagschrauber/Torsionsstab mittels eines Drehmomentschlüssels.

Etant donné que le couple peut varier selon modèle, la capacité ou l'état de la clé à choc, le contrôle de la combinaison clé à choc/barre par clé dynamométrique est indispensable.

18101M (mmxNm)		D (mm)	H (mm)	L (mm)	 (g)	 (pce.)	
24x350Nm	1"	41.5	24	300	1380	1	*1
27x350Nm		45.3	27	300	1401	1	*1
27x450Nm		45.3	27	300	1579	1	*1
30x500Nm		49	30	300	1563	1	*1
32x450Nm		51.5	32	300	1600	1	*1
32x550Nm		51.5	32	300	1602	1	*1
32x600Nm		51.5	32	300	1602	1	*1
32x650Nm		51.5	32	300	1620	1	*1
32x700Nm		51.5	32	300	1630	1	*1
33x550Nm		52.8	33	300	1638	1	*1
33x600Nm		52.8	33	300	1638	1	*1
33x650Nm		52.8	33	300	1650	1	*1
36x600Nm		56.5	36	300	1718	1	*1

*1 C-Ring=C81, Pin/O-Ring=A81/B81 → P268-269

Z-SERIES
 HAND
 TITANIUM
 SCREWDRIVERS ACCESSORIES
 IMPACT
 SLEEVE-DRIVE
 PROTECTOR
 INDUSTRIAL
 AUTOMOTIVE
 MOTORCYCLE
 CONSTRUCTION
 SPARE PART

6102M-400
8102M-400

Extra long socket for wheel nuts
 Extra lange Steckschlüssel für Radmuttern
 Douilles extra-longues pour écrous de roue

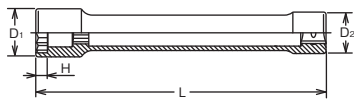

6102M-400 (mm)	□	D ₁ (mm)	D ₂ (mm)	H (mm)	L (mm)	⚖️ (g)	📦 (pce.)
41Wx21W	3/4"	58	40	14	400	1880	1
32		48.5	40	32	400	1480	1
33		49.8	40	32	400	1500	1

8102M-400 (mm)	□	D ₁ (mm)	D ₂ (mm)	H (mm)	L (mm)	⚖️ (g)	📦 (pce.)
41Wx21W	1"	58	49.9	14	400	2610	1
32		48.5	49.9	32	400	2210	1
33		49.8	49.9	32	400	2220	1

⚠️ 6102M/8102M are for hand use only. Do not use with a power tools.



Extra long Socket for wheel nut



Combination type 41Wx21W

16102M-270 / -400
18102M-270 / -400

Extra long Sockets for wheel Nuts
 Extra lange Steckschlüssel für Radmuttern
 Douilles extra-longues pour écrous de roue

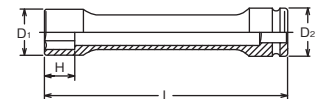

16102M-270 (mm)	□	D ₁ (mm)	D ₂ (mm)	H (mm)	L (mm)	⚖️ (g)	📦 (pce.)	⚡
24	3/4"	38.8	44	24	270	1034	1	*1
27		42.5	44	27	270	1088	1	*1
30		46.3	44	30	270	1144	1	*1
32		48.8	44	32	270	1157	1	*1
33		50	44	32	270	1200	1	*1
36		53.8	44	32	270	1250	1	*1
38		56.3	44	32	270	1610	1	*1
41		60	44	32	270	1640	1	*1

*1 C-Ring=C61, Pin/O-Ring=A61/B61 → P268-269

16102M-400 (mm)	□	D ₁ (mm)	D ₂ (mm)	H (mm)	L (mm)	⚖️ (g)	📦 (pce.)	⚡
24	3/4"	38.8	44	24	400	1430	1	*1
27		42.5	44	27	400	1460	1	*1
30		46.3	44	30	400	1510	1	*1
32		48.8	44	32	400	1530	1	*1
33		50	44	32	400	1530	1	*1
36		53.8	44	32	400	2180	1	*1

*1 C-Ring=C61, Pin/O-Ring=A61/B61 → P268-269

18102M-270 (mm)	□	D ₁ (mm)	D ₂ (mm)	H (mm)	L (mm)	⚖️ (g)	📦 (pce.)	⚡
23	1"	37.3	54	23	270	1627	1	*1
24		38.5	54	24	270	1628	1	*1
26		41	54	26	270	1667	1	*1
27		42.3	54	27	270	1680	1	*1
29		44.8	54	29	270	1680	1	*1
30		46	54	30	270	1680	1	*1
32		48.5	54	32	270	1680	1	*1
33		49.8	54	32	270	1700	1	*1
34		51	54	32	270	1750	1	*1
36		53.5	54	32	270	1750	1	*1
38		56	54	32	270	1822	1	*1
41		60	54	32	270	1800	1	*1

*1 C-Ring=C81, Pin/O-Ring=A81/B81 → P268-269

18102M-400 (mm)	□	D ₁ (mm)	D ₂ (mm)	H (mm)	L (mm)	⚖️ (g)	📦 (pce.)	⚡
23	1"	37.3	54	23	400	1865	1	*1
24		38.5	54	24	400	1869	1	*1
26		41	54	26	400	1925	1	*1
27		42.3	54	27	400	2272	1	*1
29		44.8	54	29	400	2278	1	*1
30		46	54	30	400	2266	1	*1
32		48.5	54	32	400	2322	1	*1
33		49.8	54	32	400	2320	1	*1
34		51	54	32	400	2341	1	*1
36		53.5	54	32	400	2442	1	*1
38		56	54	32	400	2550	1	*1

*1 C-Ring=C81, Pin/O-Ring=A81/B81 → P268-269

Z-SERIES
HAND
TITANIUM
ACCESSORIES
SCREWDRIVERS
IMPACT
SLEEVE-DRIVE
PROTECTOR
INDUSTRIAL
AUTOMOTIVE
MOTORCYCLE
CONSTRUCTION
SPARE PART

PW6P (mmxmm)	D ₁ (mm)	D ₂ (mm)	H (mm)	L (mm)	Shaft Color	(g)	(pcs.)	Ⓢ
32x17	47	44	12	75	Orange	621	2	*1
35x17	50	44	12	75	White	655	2	*1
38x20	55	44	12	75	Red	705	2	*1
41x19	58	44	12.5	80	Green	813	2	*1
41x20	58	44	12.5	80	Blue	813	2	*1
41x21	58	44	12.5	80	Yellow	779	2	*1

*1 C-Ring=C61, Pin/O-Ring=A61/B61 → P268-269

PW8P (mmxmm)	D ₁ (mm)	D ₂ (mm)	H (mm)	L (mm)	Shaft Color	(g)	(pcs.)	Ⓢ
35x17	50	54	12	83	White	867	2	*1
38x20	55	54	12	83	Red	941	2	*1
41x19	58	54	12.5	87	Green	1033	2	*1
41x20	58	54	12.5	87	Blue	1033	2	*1
41x21	58	54	12.5	87	Yellow	997	2	*1

*1 C-Ring=C81, Pin/O-Ring=A81/B81 → P268-269

PW8P/4 4 Pieces Set ⚖️=4,250g

CARDBOARD BOX:W240xH95xT70mm

Sockets

Ⓢ PW8P Impact Rear Wheel Nut Sockets
35x17, 38x20, 41x19, 41x21

**PW6P
PW8P** Ⓢ Rear Wheel Nut Sockets
Steckschlüssel für Hinterradmuttern
Douilles spéciales pour écrous de roué arrière

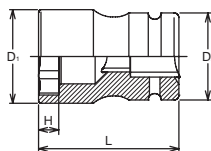

Tightening / Loosening Outer Nut

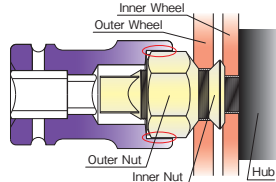

Tightening / Loosening Inner Nut

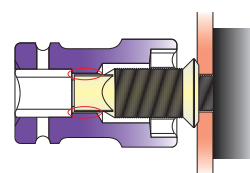

PW8P/4 Ⓢ Socket set of Rear Wheel Nut Sockets
Steckschlüssel für Hinterradmuttern, im Satz
Jeu de douilles spéciales pour écrous de roué arrière



PW8L (mmxmm)	Ⓢ	D ₁ (mm)	D ₂ (mm)	H (mm)	L (mm)	(g)	(pce.)	Ⓢ
41x21	1"	58	54	15	105	1263	1	*1

*1 C-Ring=C81, Pin/O-Ring=A81/B81 → P268-269

PW8L Ⓢ Rear Wheel Nut Socket (long)
Steckschlüssel für Hinterradmuttern, lang
Douilles spéciales pour écrous de roué arrière longue

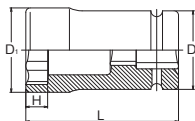

PS6 (mm)	Ⓢ	D ₁ (mm)	D ₂ (mm)	H (mm)	L (mm)	(g)	(pcs.)	Ⓢ
17		40	44	19	53	433	5	*1
19	3/4"	40	44	19	53	419	5	*1
20		44	44	21	55	483	5	*1
21		44	44	23	60	491	5	*1

*1 C-Ring=C61, Pin/O-Ring=A61/B61 → P268-269

**PS6
PS8** Ⓢ Rear Wheel Nut Sockets
Steckschlüssel für Hinterradmuttern
Douilles spéciales pour écrous de roué arrière

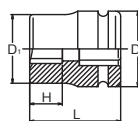

PS8 (mm)	Ⓢ	D ₁ (mm)	D ₂ (mm)	H (mm)	L (mm)	(g)	(pcs.)	Ⓢ
17		40	54	19	60	621	2	*1
19	1"	43	54	19	60	648	2	*1
20		45	54	21	62	687	2	*1
21		45	54	23	64	696	2	*1

*1 C-Ring=C81, Pin/O-Ring=A81/B81 → P268-269

Z-SERIES
 HAND
 TITANIUM
 SCREWDRIVERS ACCESSORIES
 IMPACT
 SLEEVE-DRIVE
 PROTECTOR
 INDUSTRIAL
 AUTOMOTIVE
 MOTORCYCLE
 CONSTRUCTION
 SPARE PART

14466A-200B 14488A-B / -200B

Adaptor
Verbindungsstück
Réducteur

No Warranty
Keine Garantie
Sans Garantie

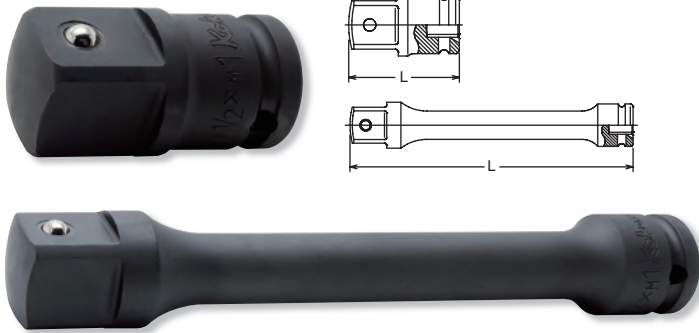
	□ (sq.)	□ (sq.)	L (mm)	⚖ (g)	📦 (pce.)	⚡
14466A-200B	1/2"	3/4"	200	560	1	*2
14488A-B	1/2"	1"	58	280	1	*2
14488A-200B	1/2"	1"	200	660	1	*2

*2 C-Ring=C42, Pin/O-Ring=A42/B42 → P268-269

(PW8P-41X21 + 14488A-200B + 1/2" SQ. Impact wrench)

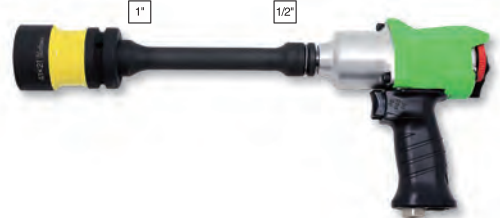

14466A-B / 14488A-B Impact Adaptors (□1/2" SQ. → □3/4", 1" SQ.)

⚠ For temporary fastening a wheel nut socket for large vehicle with a light duty 1/2" Sq.Dr. Impact wrench.

Zum vorübergehenden Festziehen einer Radmutter für große Fahrzeuge mit einem leichten 1/2-Zoll-Vierkant-Schlagschrauber.

Pour la fixation temporaire d'un écrou de roue pour les gros véhicules avec une clé à chocs légère de 1/2" Sq.Dr.

16316M / 16316A 18316M / 18316A

Rear Wheel Nut Sockets
Steckschlüssel für Hinterradmuttern
Douilles spéciales pour écrous de roue arrière



16316M (mmxmm)	□	D ₁ (mm)	D ₂ (mm)	H (mm)	L (mm)	⚖ (g)	📦 (pce.)	⚡
35x17	3/4"	52	44	10	90	865	1	*1
38x20		56	44	13	100	952	1	*1
41x19		59	44	12	100	1037	1	*1
41x21		59	44	15	100	963	1	*1

*1 C-Ring=C61, Pin/O-Ring=A61/B61 → P268-269

16316A (inchxinch)	□	D ₁ (mm)	D ₂ (mm)	H (mm)	L (mm)	⚖ (g)	📦 (pce.)	⚡
1.1/2x13/16	3/4"	56	44	13	100	940	1	*1

*1 C-Ring=C61, Pin/O-Ring=A61/B61 → P268-269

18316M (mmxmm)	□	D ₁ (mm)	D ₂ (mm)	H (mm)	L (mm)	⚖ (g)	📦 (pce.)	⚡
35x17	1"	52	54	10	108	1153	1	*1
38x20		56	54	13	108	1133	1	*1
41x19		59	54	12	108	1200	1	*1
41x21		59	54	15	108	1155	1	*1

*1 C-Ring=C81, Pin/O-Ring=A81/B81 → P268-269

18316A (inchxinch)	□	D ₁ (mm)	D ₂ (mm)	H (mm)	L (mm)	⚖ (g)	📦 (pce.)	⚡
1.1/2x13/16	1"	59	54	13	108	1120	1	*1

*1 C-Ring=C81, Pin/O-Ring=A81/B81 → P268-269

16317M / 16317A 18317M / 18317A

Rear Wheel Nut Sockets
Steckschlüssel für Hinterradmuttern
Douilles spéciales pour écrous de roue arrière



16317M (mm)	□	D ₁ (mm)	D ₂ (mm)	H (mm)	L (mm)	⚖ (g)	📦 (pce.)	⚡
17	3/4"	40	44	22.5	67	485	1	*1
19		40	44	22.5	67	462	1	*1
20		44	44	22.5	67	517	1	*1
21		44	44	22.5	67	489	1	*1
22		44	44	22.5	67	482	1	*1

*1 C-Ring=C61, Pin/O-Ring=A61/B61 → P268-269

16317A (inch)	□	D ₁ (mm)	D ₂ (mm)	H (mm)	L (mm)	⚖ (g)	📦 (pce.)	⚡
13/16	3/4"	44	44	22.5	67	489	1	*1

*1 C-Ring=C61, Pin/O-Ring=A61/B61 → P268-269

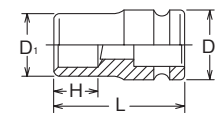

18317M (mm)	□	D ₁ (mm)	D ₂ (mm)	H (mm)	L (mm)	⚖ (g)	📦 (pce.)	⚡
17	1"	40	54	22.5	72	682	1	*1
17.5		40	54	22.5	72	677	1	*1
19		43	54	22.5	72	705	1	*1
20		45	54	22.5	72	723	1	*1
20.5		45	54	22.5	72	723	1	*1
21		45	54	22.5	72	703	1	*1
22		45	54	22.5	72	696	1	*1

*1 C-Ring=C81, Pin/O-Ring=A81/B81 → P268-269

18317A (inch)	□	D ₁ (mm)	D ₂ (mm)	H (mm)	L (mm)	⚖ (g)	📦 (pce.)	⚡
13/16	1"	45	54	22.5	72	703	1	*1

*1 C-Ring=C81, Pin/O-Ring=A81/B81 → P268-269





MOTORCYCLE TOOLS
MOTORRAD WERKZEUGE
OUTILLAGE MOTO

Z-SERIES
 HAND
 TITANIUM
 ACCESSORIES
 SCREWDRIVERS
 IMPACT
 SLEEVE-DRIVE
 PROTECTOR
 INDUSTRIAL
 AUTOMOTIVE
 MOTORCYCLE
 CONSTRUCTION
 SPARE PART

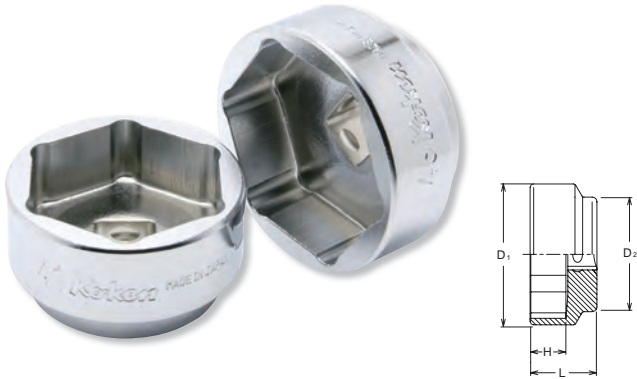
4400M (DU)  6 point Socket, extra short for Motorcycle central chain-wheel screws
 6 kant Steckschlüssel, extra kurz für Motorrad Kettenrad-Zentralmuttern
 Douille 6-pans, extra-court, pour moto, pour roue d'entraînement écrou-central





4400M		D ₁ (mm)	D ₂ (mm)	H (mm)	L (mm)		
41DU	1/2"	53	45	15	28	239	5
46DU		59	48	15	28	279	5

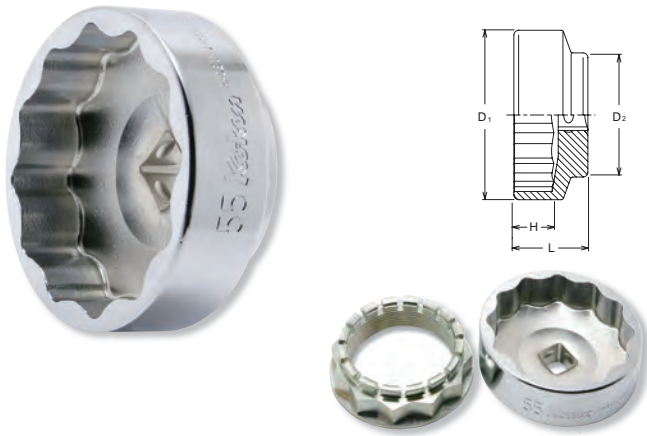

4405M (DU)  12 point Socket, extra short for motorcycle rear-axle screws
 12 kant Steckschlüssel, extra kurz, für Motorrad-Hinterradmuttern
 Douille 12-pans, extra-court, pour moto, pour écrou roue-arrière



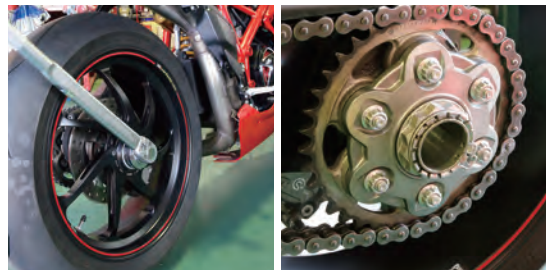

4405M		D ₁ (mm)	D ₂ (mm)	H (mm)	L (mm)		
36DU	1/2"	47.3	41	15	28	200	5
55DU		71	52	16	31	410	5

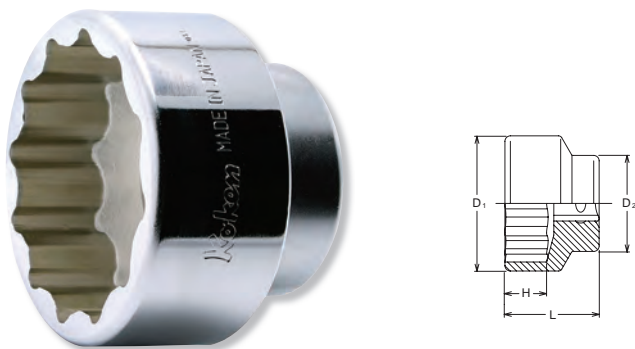

6405A (MV)  12 point Socket, extra short for motorcycle rear-axle screws
 12 kant Steckschlüssel, extra kurz, für Motorrad-Hinterradmuttern
 Douille 12-pans, extra-court, pour moto, pour écrou roue-arrière





6405A		D ₁ (mm)	D ₂ (mm)	H (mm)	L (mm)		
2.3/16MV	3/4"	74.6	53	23	52	790	2



4012M-43  Inhex Sockets
 Steckschlüssel für Innensechskant-Schrauben
 Douilles tournevis pour vis 6-pans creux



4012M-43 (mm)		D (mm)	H (mm)	L (mm)		
20	1/2"	26	11.5	43	130	10
21		26	11.5	43	140	10
22		26	11.5	43	145	10
23		28	11.5	43	170	10
24		28	11.5	43	170	10
27		32	11.5	43	226	10





3305P (mm)		D (mm)	H (mm)	L (mm)	(g)	(pcs.)
12	3/8"	16.5	6.3	70	78	10

3305P-12 : For DUCATI V4 Engines



The magnet can break by any impacts. Please handle with care.
 Der Magnet kann durch Stöße beschädigt werden. Bitte mit Vorsicht handhaben.
 L'aimant peut être brisé par n'importe quel impact. Veuillez le manipuler avec précaution.

3305P-12 Spark Plug Socket with Magnet, 12-pt. opening
 Zündkerzensteckschlüssel mit Magnet, 12-kant
 Douille pour bougies, avec aimant, 12-pans

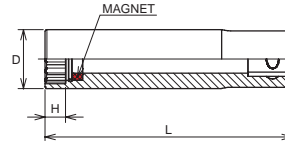

155	D (mm)	d (mm)	L (mm)	(g)	(pcs.)
	22	10	170	100	10

For Motorcycles
 Für Motorräder
 Pour motos

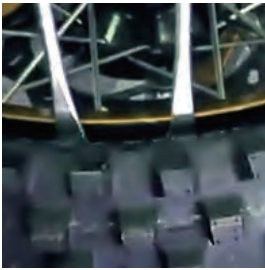

155 Tyre Lever
 Reifen und Montagehebel
 Démonte-pneu

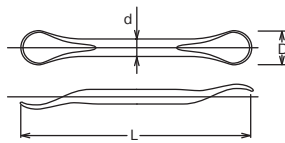

104ME (mm)	D (mm)	H (mm)	L ₁ (mm)	L ₂ (mm)	(g)	(pce.)
6	9.5	8	200	180	150	1
7	11	9	200	180	152	1
8	12	10	250	200	183	1
9	14	12	250	200	188	1
10	14	13	250	200	230	1
11	16	14	250	200	234	1
12	18	15	250	200	355	1
13	18.5	17	250	250	390	1
14	20	18	250	250	399	1
15	21	19	250	250	404	1
16	22.5	21	250	250	419	1
17	24	22	250	250	568	1
18	25	23	250	250	577	1
19	26.5	25	250	250	594	1
New 21	29	27	350	300	1070	1
New 22	30	28	350	300	1062	1
New 24	33	30	350	300	1140	1

104ME T-Handles, 6-Point
 T-Griffe, 6-kant
 Poignées en T, 6-pans

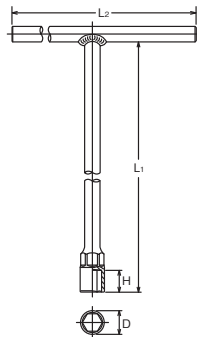

157HE (mm)	L ₁ (mm)	L ₂ (mm)	(g)	(pce.)
3	250	180	98	1
4	250	180	121	1
5	250	180	158	1
6	250	180	416	1
8	250	180	422	1
10	300	190	440	1
12	320	210	660	1

157PE (PH)	L ₁ (mm)	L ₂ (mm)	(g)	(pce.)
2	250	180	95	1
3	250	180	170	1

157T (T)	L ₁ (mm)	L ₂ (mm)	(g)	(pce.)
T25	250	180	95	1
T27	250	180	96	1
T30	250	180	167	1
T40	250	180	168	1
T45	250	180	213	1
T50	250	180	215	1

157HE T-Handles, for Inhex Screws
 T-Griffe für Innensechskant-Schrauben
 Poignées en T, pour vis à 6-pans creux

157PE T-Handles for PH Screws
 T-Griffe für Kreuzschlitzschrauben PH
 Poignées en T, pour vis à empreinte PH

157T T-Handle for TORX® Screws
 T-Griff für TORX®-Schrauben
 Poignées en T pour vis à empreinte TORX®

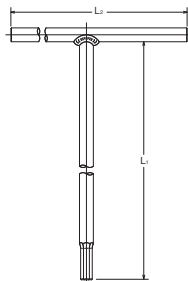

Z-SERIES
 HAND
 TITANIUM
 ACCESSORIES
 SCREWDRIVERS
 IMPACT
 SLEEVE-DRIVE
 PROTECTOR
 INDUSTRIAL
 AUTOMOTIVE
 MOTORCYCLE
 CONSTRUCTION
 SPARE PART

2263A 1/4" Socket set (Inch)
 1/4" Steckschlüsselsatz (Zoll)
 1/4" Jeu de clés à douilles (Pouce)



2263A		29 Pieces Set/△=940g	
METAL CASE:W240xH100xT32mm			
Sockets		Accessories	
	2400A 6-pt. Sockets 1/8, 5/32, 3/16, 7/32, 1/4, 9/32, 5/16, 11/32, 3/8, 7/16, 1/2		2753N
	2000.28 Bit Sockets 1, 2, 3		2760-100
	2010A.25 Bit Sockets 1/8, 5/32, 3/16, 7/32, 1/4, 9/32, 5/16		2769N-150
	2025.28 Bit Sockets T10, T15, T20, T25, T30		2770
			2785

3201AMW 3/8" Socket set (mixed Metric,Inch,Witworth)
 3/8" Steckschlüsselsatz (gemischt Metrisch,Zoll.)
 Jeu de douilles 3/8" (pouce et métrique)



3201AMW		42 Pieces Set/△=4,700g	
METAL CASE:W445xH190xT50mm			
Sockets		Accessories	
	3405M 12-pt. Sockets 9, 10, 11, 12, 13, 14, 15, 16, 17, 18, 19, 20, 21, 22		3753N
	3405A 12-pt. Sockets 5/16, 3/8, 7/16, 1/2, 9/16, 5/8, 11/16, 3/4, 25/32, 13/16, 7/8		3760-75
	3405W 12-pt. Sockets 1/8, 3/16, 1/4, 5/16, 3/8, 7/16, 1/2		3760-125
			3760-250
			3768N-250
			3769N-160
			3770
			3780
			3785
			3344A

4238AM 1/2" Socket set (mixed Metric,Inch)
 1/2" Steckschlüsselsatz (gemischt Metrisch,Zoll)
 Jeu de douilles 1/2" (pouce et métrique)



4238AM		38 Pieces Set/△=8,050g	
METAL CASE:W446xH266xT50mm			
Sockets		Accessories	
	4405M 12-pt. Sockets 10, 11, 12, 13, 14, 15, 16, 17, 18, 19, 21, 22, 23, 24, 26, 27, 30, 32		4753N
	4405A 12-pt. Sockets 3/8, 7/16, 1/2, 9/16, 5/8, 11/16, 3/4, 13/16, 7/8, 15/16, 1.1/16, 1.1/8, 1.1/4		4760-125
	4300C Spark Plug Socket 20.8		4760-250
			4770
			4780
			4785

4251A 1/2" Socket set (Inch)
 1/2" Steckschlüsselsatz (Zoll)
 Jeu de douilles (pouce) 1/2"



4251A		18 Pieces Set/△=2,660g	
METAL CASE:W330xH68xT48mm			
Sockets			
	4405A 12-pt. Sockets 3/8, 7/16, 1/2, 9/16, 5/8, 19/32, 21/32, 11/16, 3/4, 25/32, 13/16, 7/8, 15/16, 1, 1.1/16, 1.1/8, 1.3/16, 1.1/4		

**TOOLS FOR CONSTRUCTION SITES
WERKZEUGE FÜR DAS BAUGEWERBE
OUTILLAGE POUR L'INDUSTRIE DU BÂTIMENT**



Z-SERIES
 HAND
 TITANIUM
 SCREWDRIVERS ACCESSORIES
 IMPACT
 SLEEVE-DRIVE
 PROTECTOR
 INDUSTRIAL
 AUTOMOTIVE
 MOTORCYCLE
 CONSTRUCTION
 SPARE PART

BD014SE ○ 12-point Nut Setters
 12-kant Steckschlüsselklingen
 Douilles 12-pans à embout

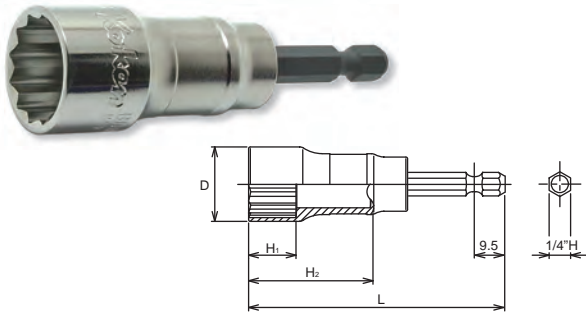

BD014SE (mm)	D (mm)	H ₁ (mm)	H ₂ (mm)	L (mm)	(g)	(pcs.)
8	12	12	36	77	35	10
10	14	12	36	77	38	10
12	16.5	14	36	77	48	10
13	17.5	14	36	77	51	10
14	19	14	36	77	54	10
17	22.5	14	36	77	76	10
19	24.5	14	36	77	83	10
21	27	14	34	77	104	10
22	28	14	34	77	120	10
24	30.3	14	34	77	140	10

● DIN 3126 Form E 6.3

BD014E ○ 12-point Nut Setters, deep
 12-kant Steckschlüsselklingen, lang
 Douilles longues, 12-pans à embout

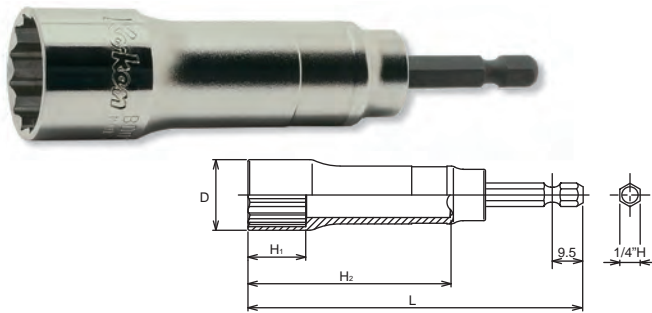

BD014E (mm)	D (mm)	H ₁ (mm)	H ₂ (mm)	L (mm)	(g)	(pcs.)
8	12	12	63	104	45	10
10	14	12	63	104	52	10
12	16.5	18	63	104	61	10
13	17.5	18	63	104	65	10
14	19	18	63	104	72	10
17	22.5	18	60	104	80	10
19	24.5	18	60	104	95	10
21	27	18	60	104	110	10
22	28	18	60	104	112	10
24	30.3	18	60	104	123	10

● DIN 3126 Form E 6.3

BD014E-140 ○ 6-point Nut Setters, extra deep
 6-kant Steckschlüsselklingen, extra lang
 Douilles extra-longues, 6-pans à embout

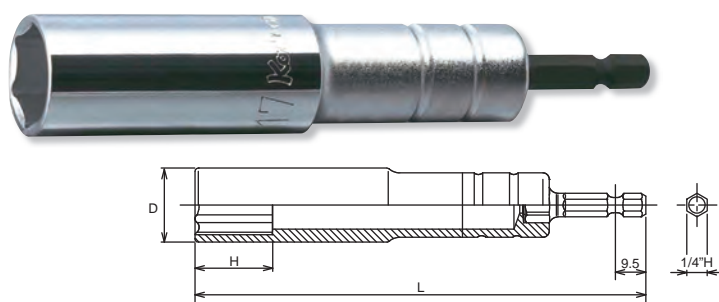

BD014E-140 (mm)	D (mm)	H (mm)	L (mm)	(g)	(pcs.)
13	19	20	140	120	10
17	24	26	140	190	10

● DIN 3126 Form E 6.3

BD042E ○ 6-point Nut Setters deep (Exchangeable Drive Shank)
 6-kant Steckschlüsselklinge lang (austauschbarer Antriebsschaft)
 Jeu d'écrus à 6 pans profonds (tige d'entraînement échangeable)

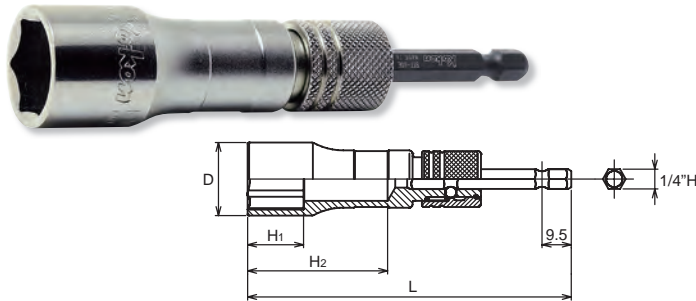

BD042E (mm)	D (mm)	H ₁ (mm)	H ₂ (mm)	L (mm)	(g)	(pcs.)
17	23.5	18	45	111	114	10
19	25.5	18	45	111	119	10
21	28	18	45	111	132	10
24	31.5	18	45	111	147	10

● DIN 3126 Form E 6.3

BIT-60E Drive bit for BD042E
 Antriebsbit für BD042E
 Embout d'entraînement pour BD042E

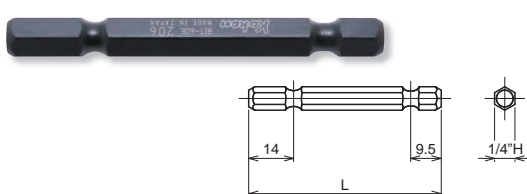

	L (mm)	(g)	(pcs.)
BIT-60E	60	10	10

● DIN 3126 Form E 6.3

BD014XE (mm)	D (mm)	H ₁ (mm)	H ₂ (mm)	L (mm)	(g)	(pcs.)
8SF	13	12	49	90	40	10
10SF	15	12	49	90	46	10
12SF	17.5	14	48	90	54	10
13SF	18.5	14	48	90	58	10
14SF	19.8	14	47	90	64	10
17SF	23.5	14	46	90	81	10
19SF	25.5	14	46	90	100	10
21SF	28	14	46	90	123	10
24SF	31.5	14	45	90	137	10

◆ DIN 3126 Form E 6.3

BD014E (mm)	D (mm)	H ₁ (mm)	H ₂ (mm)	L (mm)	(g)	(pcs.)
17SF	23.5	18	60	104	94	10
19SF	25.5	18	60	104	100	10
21SF	28	18	60	104	110	10

◆ DIN 3126 Form E 6.3

BD008E-165 (mm)	D (mm)	H ₁ (mm)	H ₂ (mm)	L (mm)	(g)	(pcs.)
17	22.8	17	110	165	105	10
19	24.8	17	110	165	135	10
21	27.3	17	110	165	142	10

◆ DIN 3126 Form E 6.3

BD011SE (mm)	D (mm)	H ₁ (mm)	H ₂ (mm)	L (mm)	(g)	(pcs.)
10	14	12	35	100	73	10
12	16.5	12	35	100	77	10
13	17.5	12	35	100	79	10
14	19	12	32	100	82	10
17	22.5	14	32	100	87	10
19	24.5	14	30	100	94	10
21	27	14	30	100	103	10
22	28	14	30	100	104	10

◆ DIN 3126 Form E 6.3

184E-64	D (mm)	H ₁ (mm)	H ₂ (mm)	L (mm)	(g)	(pcs.)
New 3/8x24UNF	12.5	14.5	13	64	34	10
New 1/2x20UNF	12.5	15.5	13	64	40	10

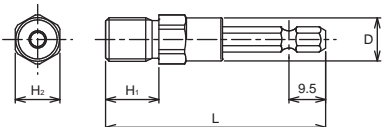

BD014XE-SF

Surface Drive Nut Setters, Semi-Deep
Surface Drive Steckschlüsselklingen, mittel lang
Douilles semi-profondes, Surface Drive

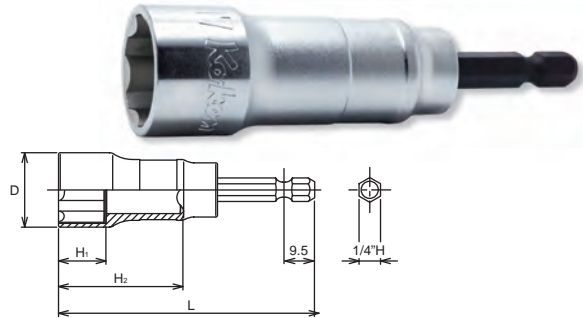

BD014E-SF

Surface Drive Nut Setters, deep
Surface Drive Steckschlüsselklingen, lang
Douilles longues, Surface Drive

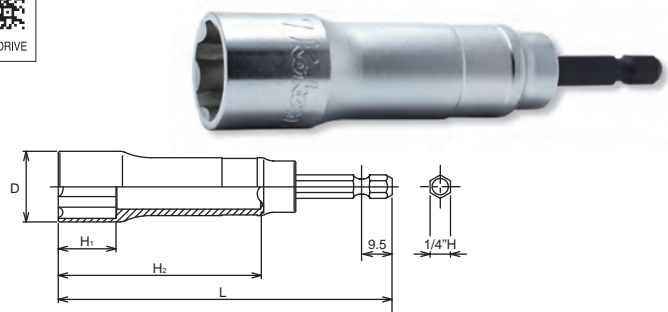

BD008E-165

12-point Nut Setter, extra long
12-kant Steckschlüsselklinge, extra lang
Douilles 12-pans à embout, extra longues

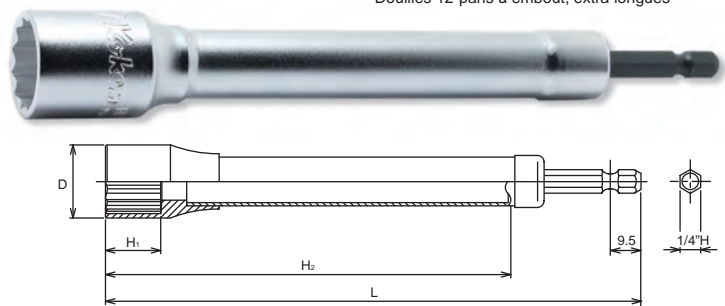

BD011SE

12-point Universal Joint Nut Setters
12-kant Steckschlüsselklingen mit Gelenk
Douilles 12-pans articulées à embout

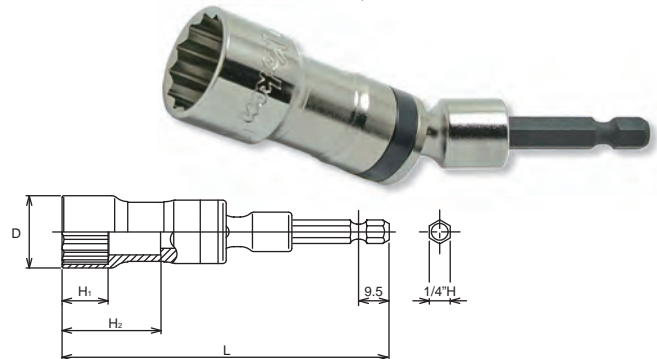

184E-64





Drill Chuck Adaptor
Bohrfutteradapter
Adaptateur de mandrin de perçage

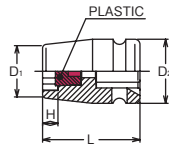

Z-SERIES
 HAND
 TITANIUM
 SCREWDRIVERS ACCESSORIES
 IMPACT
 SLEEVE-DRIVE
 PROTECTOR
 INDUSTRIAL
 AUTOMOTIVE
 MOTORCYCLE
 CONSTRUCTION
 SPARE PART

BD14400MJ  6-point Sockets for Anchor Screws
 6-kant Steckschlüssel
 Douilles 6-pans





BD14400MJ (mm)		D ₁ (mm)	D ₂ (mm)	H (mm)	L (mm)	 (g)	 (pcs.)	
13	1/2"	20.7	25	5	38	140	10	*1
15		23.2	30	5	38	145	10	*2
16		24.5	30	6.5	38	145	10	*2
17		25.7	30	6.5	38	145	10	*2
19		28.2	30	7.5	38	145	10	*2

*1 C-Ring=C41, Pin/O-Ring=A41/B41
 *2 C-Ring=C42, Pin/O-Ring=A42/B42  P268-269

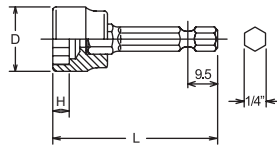
BD016E  6-point Sockets for Anchor Screws
 6-kant Steckschlüssel
 Douilles 6-pans





BD016E (mm)	D (mm)	H (mm)	L (mm)	 (g)	 (pcs.)
13	19.5	4	50	43	10
17	24.5	5	50	56	10
19	27	6	50	68	10

● DIN 3126 Form E 6.3

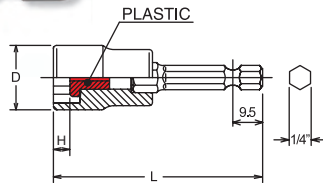
BD016JE  6-point Nut Setters with Plastic Stops
 6-kant Steckschlüsselklingen mit Plastik-Anschlag
 Douilles 6-pans à embout avec arrêt en plastique





BD016JE (mm)	D (mm)	H (mm)	L (mm)	 (g)	 (pcs.)
13	19.5	5	60	66	10
17	24.5	6.5	60	80	10
19	27	7.5	60	90	10

● DIN 3126 Form E 6.3

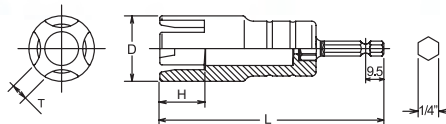
BD017E Wing Bolt Socket for Electric Drill
 6-kant Steckschlüsselklingen für Flügelschrauben
 Douilles 6-pans à embout pour ecrous à oreilles



BD017E	D (mm)	T (mm)	H (mm)	L (mm)	 (g)	 (pcs.)
	31	7.3	21	104	158	10

● DIN 3126 Form E 6.3



BD018		D (mm)	T (mm)	H (mm)	L (mm)	(g)	(pcs.)	
	3/8"	31	7.3	21	45	113	10	*2

*2 C-Ring=C32, Pin/O-Ring=A32/B32 → P268-269

BD018 Wing Bolt Socket
Steckschlüssel für Flügelschrauben
Douilles pour écrous à oreilles

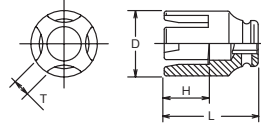

3119 (mm)		T ₁ ×T ₂ (mm)	D ₁ (mm)	D ₂ (mm)	d (mm)	L (mm)	(g)	(pcs.)
3 x5	3/8"	3 x5	17	17.3	11	30	30	10
5.5x6		5.5x6	21	19.5	14	33	45	10



For Wing Bolt
Für Flügelschrauben
Pour écrous à oreilles



For Drain Plug in Radiator
Für Kühler-Ablasschrauben
Pour le vidange du radiateur

3119 Wing Bolt Socket
Steckschlüssel für Flügelschrauben
Douilles pour écrous à oreilles

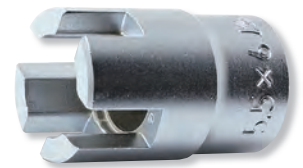
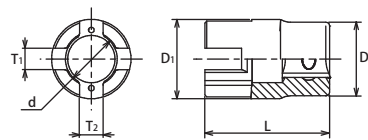

162E (mm)	D (mm)	L (mm)	(g)	(pcs.)
8	23	66	82	10
10	27.9	66	107	10

162E (inch)	D (mm)	L (mm)	(g)	(pcs.)
1/4	23	66	83	10
5/16	23	66	82	10
3/8	27.9	66	107	10
1/2	27.9	66	108	10

◆ DIN 3126 Form E 6.3

162E Stud Setters
Stehbolzeneindreher
Monte-goujons

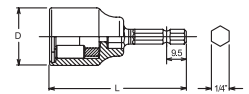
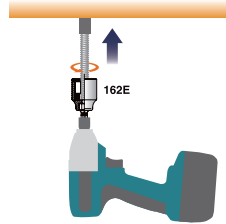

BD004 (mm)		D ₁ (mm)	D ₂ (mm)	L (mm)	(g)	(pcs.)
12.5x10	1/2"	30	25	70	236	5
12.5x13		38	30	75	388	5
12.5x16		38	30	75	369	5
20 x19	3/4"	48	44	90	775	2
20 x22		48	44	90	752	2
20 x25		62	44	95	1184	2
20 x29		62	44	95	1148	2



BD004 Impact Screw and Stud Setters
Impact Stehbolzeneindreher
Monte goujons, Impact

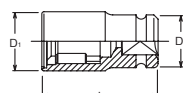

Z-SERIES
 HAND
 TITANIUM
 SCREWDRIVERS ACCESSORIES
 IMPACT
 SLEEVE-DRIVE
 PROTECTOR
 INDUSTRIAL
 AUTOMOTIVE
 MOTORCYCLE
 CONSTRUCTION
 SPARE PART

HA001 Stud Setters
 Stehbolzeneindreher
 Monte-goujons

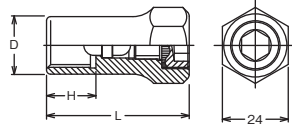

HA001	D (mm)	H (mm)	L (mm)	(g)	(pcs.)
10(1.5)	15.5	13	47	90	10
12(1.75)	17.2	15	49	100	10
16(2.0)	21	18	52	125	10
20(2.5)	24.5	21	56	155	10
22(2.5)	26.5	27	61	175	10
24(3.0)	28	28	62	185	10

HA003 Drive Part
 Antriebsteil
 Propulseur

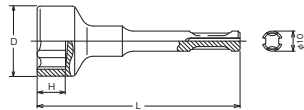
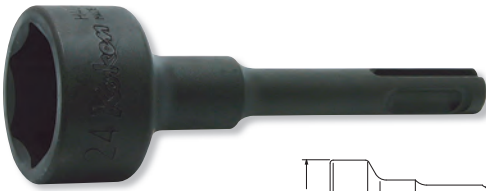

HA003 (mm)	D (mm)	H (mm)	L (mm)	(g)	(pcs.)
24	34.5	14	100	155	10

Socket for HA001



BD022-120P Hammer Drill Adaptor
 Adapter für Schlagbohrmaschinen
 Adaptateur pour aléseuses

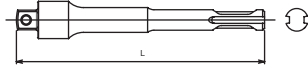

BD022-120P		L (mm)	(g)	(pcs.)
3/8	3/8"	120	100	10
1/2	1/2"	120	160	10

BD023E Adaptors
 Verbindungsstücke
 Adaptateurs

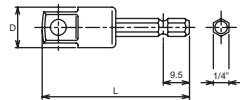

BD023E		D (mm)	L (mm)	(g)	(pcs.)
3/8	3/8"	12.5	55	27	10
1/2	1/2"	16.5	60	48	10

● DIN 3126 Form E 6.3

BD024E Universal Adaptors
 Gelenk Adapter
 Augmentator articulé

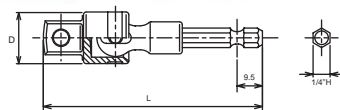

BD024E		D (mm)	L (mm)	(g)	(pcs.)
3/8	3/8"	19.3	78	63	10
1/2	1/2"	19.3	82	73	10

● DIN 3126 Form E 6.3

170S (mm)	D (mm)	T (mm)	L (mm)	(g)	(pce.)
10x12	34	38	250	260	1
12x14	34	38	250	260	1

171S (mm)	D (mm)	T (mm)	L (mm)	(g)	(pce.)
14x17	44.6	50	250	460	1
17x19	44.6	50	250	460	1
17x21	44.6	50	250	460	1
19x21	44.6	50	250	460	1

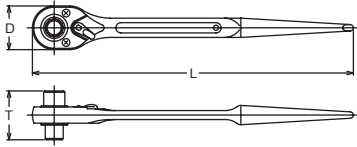

170S ○ Spud Handle Ratchets, reversible
Doppelseitige Gerüstbauknarre, umstellbar
Cliquets, réversibles, pour assemblage et démontage - échafaudages, manche pointu



171S ○ Spud Handle Ratchets, reversible
Doppelseitige Gerüstbauknarre, umstellbar
Cliquets, réversibles, pour assemblage et démontage - échafaudages, manche pointu



171 ○ Spud Handle Ratchets (Long), reversible
Doppelseitige Gerüstbauknarre, lange Ausführung, umstellbar
Cliquets longs, réversibles, pour assemblage et démontage - échafaudages, manche pointu

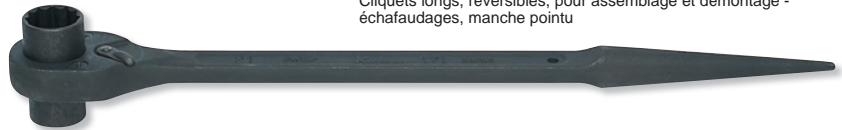

171 (mm)	D (mm)	T (mm)	L (mm)	(g)	(pce.)
14x17	44.6	50	380	630	1
17x19	44.6	50	380	630	1
17x21	44.6	50	380	630	1
19x21	44.6	50	380	630	1

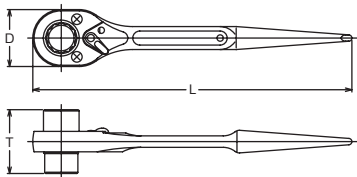

172 ○ Spud Handle Ratchets (Long), reversible
Doppelseitige Gerüstbauknarre, lange Ausführung, umstellbar
Cliquets longs, réversibles, pour assemblage et démontage - échafaudages, manche pointu

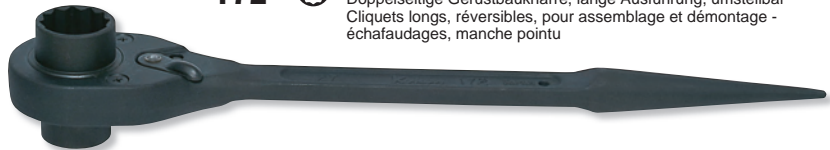

172 (mm)	D (mm)	T (mm)	L (mm)	(g)	(pce.)
21x26	68	58	380	1100	1
22x24	68	58	380	1100	1
23x26	68	58	380	1100	1
24x27	68	58	380	1100	1
26x32	68	63	380	1100	1

171SB-1/2	D (mm)	T (mm)	L (mm)	(g)	(pce.)
1/2"	44.6	33	250	480	1

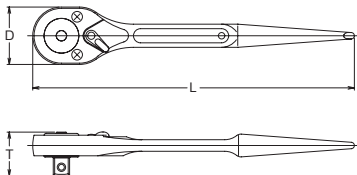

171SB-1/2 Spud Handle Ratchet with Push Button (short)
Gerüstbauknarre mit Arretierungsknopf (kurz)
Cliquet d'échafaudage avec bouton de verrouillage (court)



171B-1/2 Spud Handle Ratchet with Push Button (long)
Gerüstbauknarre mit Arretierungsknopf (lang)
Cliquet d'échafaudage avec bouton de verrouillage (long)



171B-1/2	D (mm)	T (mm)	L (mm)	(g)	(pce.)
1/2"	44.6	33	380	650	1

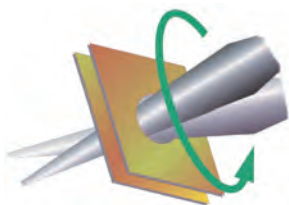

Twin Opening Spud Handle Ratchets
The tapered handle is designed to align bolt holes in flanges, rivet holes or similar assemblies.

Knarren mit doppelseitiger Steckschlüssel-Kombination und konischem Griff für die Ausrichtung von Bohrlöchern z. B. an Flanschen und Gerüsten.

Cliquets à tête double avec manche conique pour aligner les trous des boulons lors des travaux d'échafaudage ou de tout travail de construction.



Ko-ken welcomes customer's enquiries for special tools.
New items can be designed and manufactured according to customers
requirements. Please enquire through your distributors.

Wir nehmen auch gerne Ihre Anfrage für Sonderartikel entgegen.
Sonderartikel fertigen wir nach Ihren Anweisungen.
Richten Sie Ihre Anfragen bitte an Ihren örtlichen Händler.

Nous étudierons volontier toute demande d'outils spéciaux.
Nous pouvons concevoir et fabriquer tout outil selon vos spécifications.
Veuillez contacter votre distributeur habituel.

**SPARE PART SETS
ERSATZTEILSÄTZE
PIÈCES DE RECHANGE**



Spare Part Sets
Ersatzteilsätze
Pièces de rechange

Z-SERIES
HAND
TITANIUM
ACCESSORIES
SCREWDRIVERS
IMPACT
SLEEVE-DRIVE
PROTECTOR
INDUSTRIAL
AUTOMOTIVE
MOTORCYCLE
CONSTRUCTION
SPARE PART

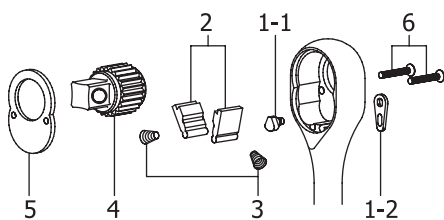
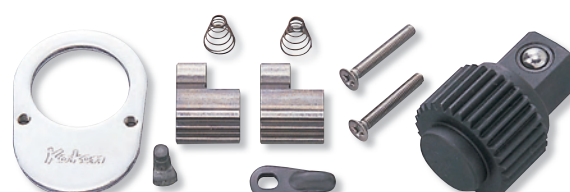
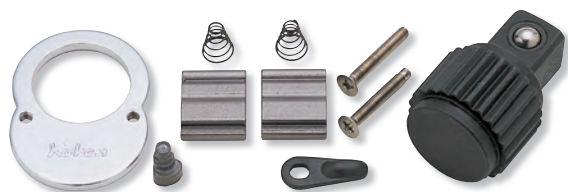

- 1-1 Reversion Cam
- 1-2 Reversion Lever
- 2 Dog
- 3 Spring
- 4 Square Drive
- 5 Cover plate
- 6 Screw

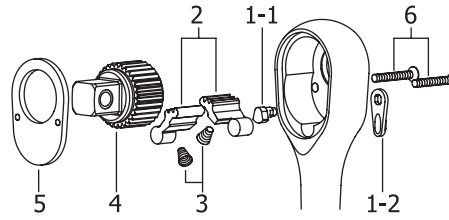

- 1-1 Reversion Cam
- 1-2 Reversion Lever
- 2 Dog
- 3 Spring
- 4 Square Drive
- 5 Cover plate
- 6 Screw

	▣	Products	(g)	(pce.)
2749RK		2749N/P/J	30	1
2753RK	1/4"	2753N/P/J, 2753PS/PSKR, 2753P-160, 2774PS/JS, 2774N/P/J	30	1
2753BRK		2753NB/PB/JB	31	1
2749RK-3/8		2749PS-3/8, 2749N-3/8, 2749P-3/8, 2774PS-3/8, 2774JS-3/8	45	1
3749RK		3749S, 3749N	70	1
3749BRK	3/8"	3749SB	84	1
3753RK		3753N/P/J, 3753SM, 3753P-250, 3774N/P/J, 3774PS, 3774NL/PL/JL	84	1
3753BRK		3753NB/PB/JB, 3753SMB, 3774NB/PB/JB/JBL	76	1
3749SRK-1/2		3749S-1/2	120	1
3749SBRK-1/2		3749SB-1/2	120	1
4749RK	1/2"	4749N-250, 4749N-380, 4749J-380	130	1
4753RK		4753N/P/J, 4753P-410, 4774N/P/J, 4774P-450	130	1
4753BRK		4753NB/PB/JB, 4774NB/PB/JB	130	1
6749RK	3/4"	6749, 6749-1000	580	1
8749RK	1"	8749, 8749-1000	800	1

	▣	Products	(g)	(pce.)
4750RK	1/2"	4750N/P/J	130	1
4750BRK		4750NB/PB/JB	130	1

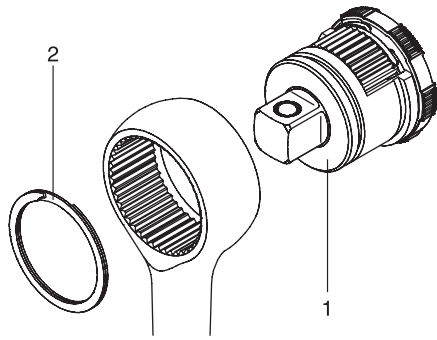
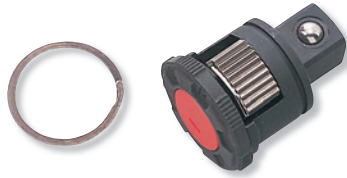

1 Head
2 Retaining Ring

	□	Products	(g)	(pce.)
3752RK	3/8"	3752N/J, 3757, 3776N/P/J	84	1
4752RK	1/2"	4752N/J	140	1

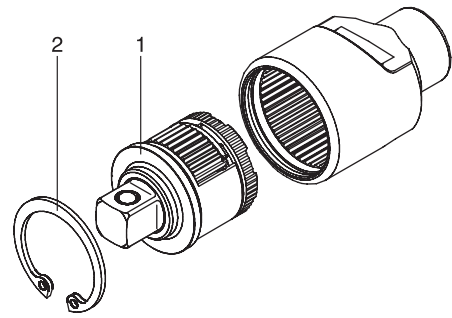

1 Head
2 Retaining Ring

	□	Products	(g)	(pce.)
2755RK	1/4"	2755	40	1
3755RK	3/8"	3755	98	1
4755RK	1/2"	4755	137	1
6755RK	3/4"	6755	550	1

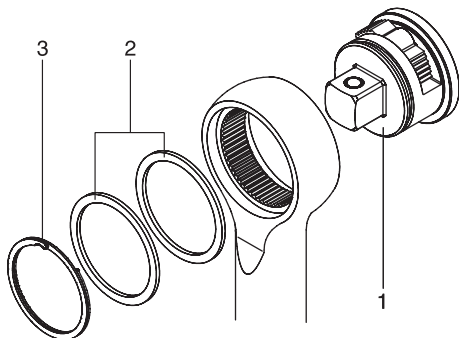

1 Head
2 Ring
3 Retaining Ring

	□	Products	(g)	(pce.)
6752RK	3/4"	6752	600	1

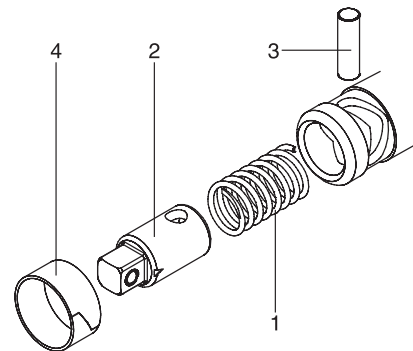

1 Spring
2 Square Drive
3 Pin
4 Retaining Ring

	□	Products	(g)	(pce.)
3112RK	3/8"	3112N	106	1
4112RK	1/2"	4112N	116	1
6112RK	3/4"	6112	445	1

Z-SERIES
HAND
TITANIUM
ACCESSORIES
SREWDRIVERS
IMPACT
SLEEVE-DRIVE
PROTECTOR
INDUSTRIAL
AUTOMOTIVE
CONSTRUCTION
MOTORCYCLE
SPARE PART

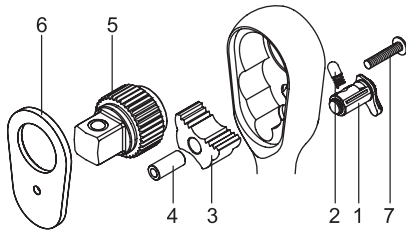

- 1 Reversion Lever
- 2 Pin+Spring
- 3 Pawl
- 4 Sleeve
- 5 Square Drive
- 6 Cover Plate
- 7 Screw

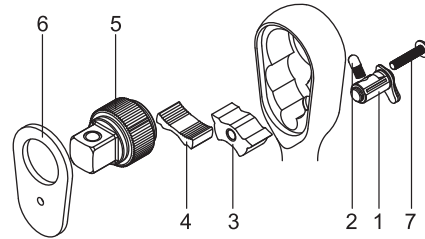

- 1 Reversion Lever
- 2 Pin+Spring
- 3 Pawl (Large)
- 4 Pawl (Small)
- 5 Square Drive
- 6 Cover Plate
- 7 Screw

For 36 Tooth

	□	Products	(g)	(pce.)
2725RK-1	1/4"	2725Z, 2725Z-160, 2726Z, 2726Z-160	30	1
2725RK-3/8	3/8"	2725Z-3/8, 2725Z-3/8(L160), 2726Z-3/8, 2726Z-3/8(L160)	45	1
3725RK-1	3/8"	3725Z, 3725ZS, 3725Z-280, 3726Z, 3726ZS, 3726Z-280	50	1
4725RK-1	1/2"	4725Z	120	1

For 72 Tooth

	□	Products	(g)	(pce.)
New 2725RK-2	1/4"	2725Z, 2725Z-160, 2726Z, 2726Z-160	30	1
New 2725RK-2(3/8)	3/8"	2725Z-3/8, 2725Z-3/8(L160), 2726Z-3/8, 2726Z-3/8(L160)	45	1
New 2725BRK-1(3/8)	3/8"	2725ZB-3/8, 2725ZB-3/8(L160), 2726ZB-3/8, 2726ZB-3/8(L160)	45	1
New 3725RK-2	3/8"	3725Z, 3725ZS, 3725Z-280, 3726Z, 3726ZS, 3726Z-280	50	1
New 3725BRK-1	3/8"	3725ZB, 3725ZSB, 3725ZB-280, 3726ZB, 3726ZSB, 3726ZB-280	50	1
New 4725RK-2	1/2"	4725Z	120	1
New 4725BRK-1	1/2"	4725ZB	120	1

⚠ 72 teeth repair kit do not fit on 36 teeth ratchets
Das Reparaturset mit 72 Zähnen passt nicht auf Ratschen mit 36 Zähnen
Le kit de réparation 72 dents ne convient pas aux cliquets 36 dents

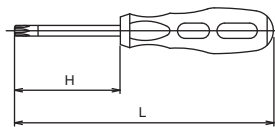

Screwdriver / Schraubendreher / Tournevis

For the mounting of repair sets
Zur Montage von Reparatursätzen
Pour l'installation de kits de réparation

TORXPLUS® 6IP Screwdriver for 2725RK
TORXPLUS® 8IP Screwdriver for 3725RK
TORXPLUS® 10IP Screwdriver for 4725RK

168T (IP)	H (mm)	L (mm)	(g)	(pce.)
6IP(40)	40	110	20	1
8IP(40)	40	110	20	1
10IP(40)	40	110	22	1

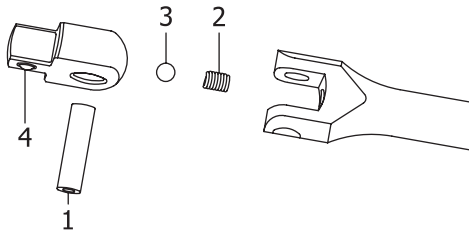

- 1 Pin
- 2 Coil Spring
- 3 Ball
- 4 Square Drive

	▣	Products	(g)	(pce.)
2768RK	1/4"	2768N/P/J	40	1

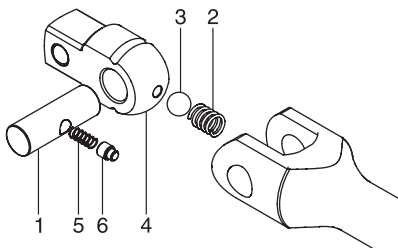

- 1 Pin
- 2 Coil Spring
- 3 Ball
- 4 Square Drive
- 5 Coil Spring
- 6 Plunger



	▣	Products	(g)	(pce.)
3768RK	3/8"	3768N-175/250/300, 3768P-250/380, 3768J-250	40	1
3768ZRK	3/8"	3768Z-250/400	40	1
4768RK	1/2"	4768N-300/380/450/600, 4768N-380/450/600, 4768J-380/450/600, 4781N-450	137	1
4768ZRK	1/2"	4768Z-430	137	1
6768RK	3/4"	6768, 6768-600, 6768-1000	175	1
8768RK	1"	8768, 8768-1000	465	1

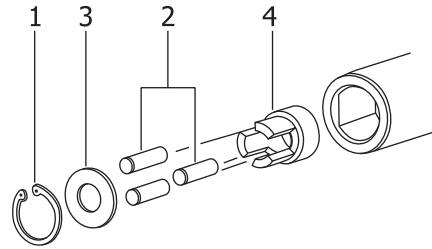
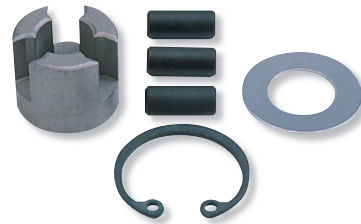

- 1 Retaining Ring
- 2 Roller
- 3 Cover
- 4 Cage

4100MRK (mm)	▣	Products	(pce.)
6	1/2"	4100M-6	1
7		4100M-7	1
8		4100M-8	1
9		4100M-9	1
10		4100M-10	1
10.5		4100M-10.5	1
11		4100M-11	1
12		4100M-12	1
14		4100M-14	1
16		4100M-16	1

4100ARK (inch)	▣	Products	(pce.)
1/4	1/2"	4100A-1/4	1
5/16		4100A-5/16	1
3/8		4100A-3/8	1
7/16		4100A-7/16	1
1/2		4100A-1/2	1
9/16		4100A-9/16	1
5/8		4100A-5/8	1

6100MRK (mm)	▣	Products	(pce.)
18	3/4"	6100M-18	1
20		6100M-20	1
22		6100M-22	1
24		6100M-24	1
27		6100M-27	1
28		6100M-28	1
29		6100M-29	1
30		6100M-30	1

162RK	Products	(pce.)
5/16	162E-5/16	1
3/8	162E-3/8	1
1/2	162E-1/2	1
10	162E-10	1

HAND SOCKETS/ Diameter of Bore
 HAND STECKSCHLÜSSEL/ Bohrungsdurchmesser
 DOUILLES A MAIN/ Diamètre d'ouverture

Standard Socket



Deep Socket

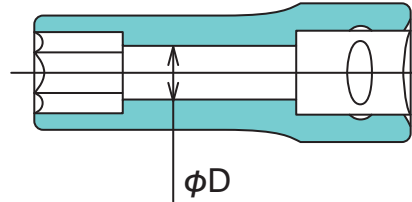
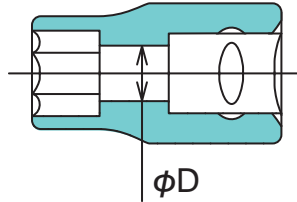

SOCKET		1/4" O		3/8" O		1/2" O		3/4" O		1" O
		Standard	Deep	Standard	Deep	Standard	Deep	Standard	Deep	Standard
		2400M 2400A	2300M 2300A	3400M 3400A	3300M 3300A	4400M 4400A	4300M 4300A	6400M 6400A	6300M 6300A	8400M 8400A
		2405M 2405A	2305M 2305A	3405M 3405A	3305M 3305A	4405M 4405A	4305M 4305A	6405M 6405A	6305M 6305A	8405M 8405A
(mm)	(inch)	ϕD								
3	1/8	2.5	2.5							
4		3	3							
4.5		3.5	3.5							
5	3/16	4	4							
5.5	7/32	4.5	4.5	4.5	4.5					
6	1/4	4.5	5	5	5					
7	9/32	6.2	6	5.5	6					
8	5/16	6.2	7	6	7	6	7			
9	11/32	8.3	8.3	7	8	7	8			
10	3/8	9.4	9	8	9	8	9			
11	7/16	10	10	9	10	9	10			
12		10	11	10	11	10	11			
13	1/2	11.5	12	11	12	11	12			
14	9/16	13	13	13.5	13.5	12	13			
15	19/32			13	14	13	14			
16	5/8			14	15	14	15			
17	21/32			15	16	15	16	15	16	
18	11/16			15	17	15	17	15	17	
19	3/4			16	18	18	18	16	18	
20	25/32			17	19	18	19	17	19	
21	13/16			18	20	18	20	18	20	
22	7/8			19	21	19	21	19	21	
23				20	22	20	22	20	22	
24	15/16			21	23	21	23	21	23	
25				22	24	22	24	22	24	
26	1			23	25	23	25	23	25	
27	1- 1/16				26	23	26	23	26	23
28						24	27	24	27	24
29	1- 1/8					24	28	24	28	24
30	1- 3/16					25	29	25	29	25
31						26	30	26	30	26
32	1- 1/4					27	31	27	31	27
33	1- 5/16					28	32	28	32	28
34						29	33	29	33	29
35	1- 3/8					30	34	30	34	30
36						31	35	31	35	31
37	1- 7/16					31	36	31	36	31
38	1- 1/2					32	37	32	37	32
39								32	38	32
40	1- 9/16							33	39	33
41	1- 5/8							34	40	34
42								34	41	34
43	1-11/16							35	42	35
44	1- 3/4							36	43	36
45								36	44	36
46	1-13/16							37	45	37
47								38	46	38
48	1- 7/8							38	47	38
	1-15/16							39	48	39
50	2							40	49	40
	2- 1/16							40		

IMPACT SOCKETS/ Diameter of Bore
 IMPACT STECKSCHLÜSSEL/ Bohrungsdurchmesser
 DOUILLES IMPACT / Diamètre d'ouverture

Standard Socket



Deep Socket

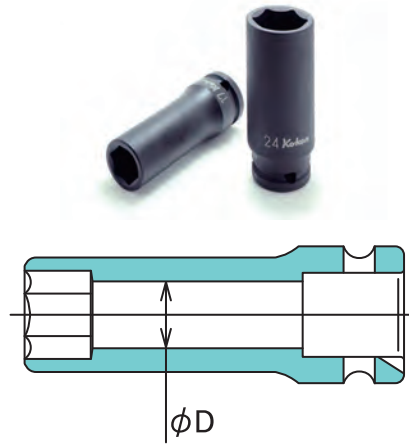

SOCKET		1/4" Ø		3/8" Ø		1/2" Ø		3/4" Ø		1" Ø	
		Standard	Standard	Deep	Standard	Deep	Standard	Deep	Standard	Deep	
Ø		12400M 12400A	13400M 13400A	13300M 13300A	14400M 14400A	14300M 14300A	16400M 16400A	16300M 16300A	18400M 18400A	18300M 18300A	
(mm)	(inch)	φD									
4		3									
4.5	3/16	3									
5		4									
5.5		4									
6	1/4	5	5	5							
7	9/32	5	5	6							
8	5/16	6	6	7	6	7					
9	11/32	7	7	8	7	8					
10	3/8	8	8	9	8	9					
11	7/16	9	9	10	9	10					
12		10	10	11	10	11					
13	1/2	11	11	12	11	12					
14	9/16	12	12	13	12	13					
15			13	14	13	14					
16	5/8		14	15	14	15	14	15			
17	11/16		14	16	14	16	14	16			
18			15	17	15	17	15	17			
19	3/4		16	18	16	18	16	18	16	18	
20			17	19	17	19	17	19	17	19	
21	13/16		18	20	18	20	18	20	18	20	
22	7/8		19	21	19	21	19	21	19	21	
23			20		20	22	20	22	20	22	
24	15/16		20		21	23	21	23	21	23	
25	1				22	24	22	24	22	24	
26					23	25	23	25	23	25	
27	1- 1/16				23	26	23	26	23	26	
28					23	27	24	27	24	27	
29	1- 1/8				23	28	25	28	25	28	
30	1- 3/16				23	29	26	29	26	29	
31					23	30	27	30	27	30	
32	1- 1/4				23	31	28	31	28	31	
33					25	32	29	32	29	32	
34	1- 5/16				25	33	30	33	30	33	
35	1- 3/8				25	34	31	34	31	34	
36					28	35	32	35	32	35	
37	1- 7/16						32	36	32	36	
38	1- 1/2						34	37	34	37	
40	1- 9/16						34	39	34	39	
41	1- 5/8						35	40	35	40	
42	1-11/16						35	41	35	41	
45	1- 3/4						35	44	35	44	
46	1-13/16						40	45	40	45	
47							40	46			
	1- 7/8						40	47			

Screw dimension	Hexagon Head Bolt			Hexagon Socket Head Cap Screws			TORX		TORXPLUS		Triple Square	LHSTIX	Ref.) Standard Tightning Torque (Nm)				
	Standard	Compact	High Strength	Standard	Button Head / Shoulder Head	Hexagon Socket Set Screws	T	E	IP	EP [EPL]	XZN	LH-S [LH-SS]	Grade 4.6	Grade 6.8	Grade 8.8	Grade 10.9	Grade 12.9
M2	4			1.5		0.9	T6/T8		6IP				0.12	0.24	0.32	0.45	0.54
M2.5	5			2		1.3	T8		8IP		M3		0.25	0.49	0.65	0.92	1.1
M3	5.5			2.5	2	1.5	T10	E4	8IP/10IP	4EP	M3		0.43	0.87	1.16	1.63	1.96
M3.5	(6)						T15		10IP/15IP				0.68	1.37	1.82	2.56	3.08
M4	7			3	2.5	2	T20/T25	E5	15IP/20IP	5EP	M4	LH4S	1.01	2.02	2.7	3.79	4.54
M5	8			4	3	2.5	T25/T27	E6	20IP/25IP /27IP	6EP [8EPL]	M5	LH5S	2.04	4.09	5.47	7.67	9.18
M6	10			5	4	3	T30	E8	27IP/30IP	8EP [10EPL]	M6	LH6S	3.47	6.97	9.27	13	15.6
M7	11						T40	E8	40IP	8EP [12EPL]			5.85	11.6	15.5	21.8	26.2
M8	13	(12)		6	5	4	T40/T45	E10	40IP/45IP	10EP [14EPL]	M8	LH8S	8.41	16.9	22.5	31.6	37.9
M10	16 (17)	(14)		8	6	5	T50	E12	45IP/50IP	12EP [16EPL]	M10	LH10S [LH8SS]	16.7	33.4	44.5	62.6	75.2
M12	18 (19)	(17)	21 (22)	10	8	6	T55	E14	55IP	14EP [20EPL]	M12	LH12S [LH10SS]	29.1	58.3	77.6	109	131
M14	21 (22)	(19)		12			T55/T60	E14/E18	55IP/60IP	18EP [24EPL]	M14	LH14S [LH12SS]	46.4	92.7	124	174	209
M16	24	(22)	27	14	10	8	T60/T70	E16/E20	60IP/70IP	20EP [26EPL]	M16	LH16S [LH14SS]	72.3	145	194	271	325
M18	27	(24)		(14)			T70/T80	E24	80IP	24EP [30EPL]	M18		100	199	266	373	447
M20	30 (32)	(27/29)	32	17	12	10	T80/T90	E24	90IP	24EP [32EPL]			141	282	376	529	635
M22	34 (32/35)	(30/32)	36	(17)			T90/T100	E28	100IP	24EP [36EPL]			192	384	511	720	865
M24	36 (38)	(32/35)	41	19		12	T100	E32	100IP	32EP [40EPL]			244	488	650	915	1100
M27	41	(36)	46	(19)				E32		32EP			358	713	951	1340	1610
M30	46	(41)	50	22				E36		36EP			484	971	1290	1820	2180
M33	50	(46)		(24)				E40		40EP			661	1320	1760	2470	2970
M36	55 (54)	(50)		27				E44		44EP			848	1690	2260	3180	3810
M39	60 (58)	(55)		(27)									1100	2190	2920	4110	4930
M42	65 (63)			32									1350	2710	3610	5080	6080
M45	70 (67)			(32)									1700	3400	4540	6370	7630
M48	75 (71)			36									2030	4060	5440	7620	9120
M52	80 (77)			(36)									2640	5290	7040	9880	11800
M56	85			41									3270	6560	8710	12300	14800
M60	90												4080	8180	10900	15300	18300
M64	95			46									4930	9890	13100	18500	22300
M68	(100)												5970	12000	16000	22500	27000

*Reference: Hexagon Head Bolt: ISO 4014-4018, 8676, 8768
 High Strength Hexagon Bolt: JIS B 1196
 Hexagon Socket Head Cap Screws: ISO 7380
 Hexagon Socket Button Head Screws: ISO 7380
 Hexagon Socket Set Screws: ISO 4026-4029
 TORX T/E: TORX Standard TMH series
 TORXPLUS IP/EP: TORXPLUS Standard CMH series
 Triple Square: DIN 2324/2325
 LHSTIX LH-S/SS: LH-S/SS Standard

* Standard Tightening Torque: Calculated based on Torque Coefficient (K): 0.2
 Axial Force (Ff) : 60% of Proof Strength(σ)

TORX is a registered trademark of CAMCAR Innovations.
TORX ist ein registriertes Markenzeichen der Firma CAMCAR Innovations.
TORX est une marque déposée de CAMCAR Innovations.

TORXplus is a registered trademark of CAMCAR Innovations.
TORXplus ist ein registriertes Markenzeichen der Firma CAMCAR Innovations.
TORXplus est une marque déposée de CAMCAR Innovations.

LHSTIX is a registered trademark of OSG SYSTEM PRODUCTS CO., LTD.
LHSTIX ist ein registriertes Markenzeichen der Firma OSG SYSTEM PRODUCTS CO., LTD.
LHSTIX est une marque déposée de OSG SYSTEM PRODUCTS CO., LTD.

TORX® BITS(T/TH)

	S ₁ (mm)	S ₂ (mm)
T6	1.7	1.2
T7	2.0	1.4
T8	2.3	1.7
T9	2.5	1.8
T10	2.7	2.0
T15	3.3	2.3
T20	3.9	2.8
T25	4.5	3.2
T27	5.0	3.6
T30	5.6	4.0
T40	6.7	4.8
T45	7.9	5.6
T50	8.9	6.2
T55	11.3	8.0
T60	13.3	9.5
T70	15.6	11.1
T80	17.6	12.7
T90	20.0	14.2
T100	22.2	15.8

TORX^{plus} BITS(IP)

	S ₁ (mm)	S ₂ (mm)
6IP	1.7	1.3
7IP	2.0	1.5
8IP	2.3	1.8
9IP	2.5	1.9
10IP	2.7	2.1
15IP	3.3	2.5
20IP	3.9	3.0
25IP	4.5	3.4
27IP	5.0	3.9
30IP	5.6	4.3
40IP	6.7	5.2
45IP	7.9	6.2
50IP	8.9	6.9
55IP	11.3	9.0
60IP	13.3	10.4
70IP	15.6	12.3
80IP	17.6	13.7
90IP	20.0	15.7
100IP	22.2	17.5

TORX^{plus} Tamper-Resistant BITS(IPR)

	S ₁ (mm)	S ₂ (mm)
8IPR	2.2	2.0
9IPR	2.4	2.2
10IPR	2.6	2.4
15IPR	3.1	2.8
20IPR	3.6	3.3
25IPR	4.1	3.8
27IPR	4.7	4.3
30IPR	5.2	4.8
40IPR	6.3	5.7
45IPR	7.4	6.7
50IPR	8.4	7.6
55IPR	10.6	9.7

TORX® SOCKETS(E)

	S ₁ (mm)	S ₂ (mm)
E4	3.7	2.7
E5	4.6	3.3
E6	5.6	4.0
E7	6.1	4.3
E8	7.4	5.3
E10	9.3	6.8
E11	9.9	7.1
E12	11.0	7.9
E14	12.8	9.2
E16	14.6	10.5
E18	16.5	11.9
E20	18.3	13.2
E22	20.1	14.8
E24	22.0	15.7
E26	23.7	17.5
E28	25.5	18.3
E30	27.3	20.0
E32	29.0	21.3

TORX^{plus} SOCKETS(EP/EPL)

	S ₁ (mm)	S ₂ (mm)
4EP	3.7	2.9
5EP	4.6	3.5
6EP	5.6	4.3
7EP	6.1	4.7
8EP	7.4	5.7
10EP	9.3	7.1
11EP	9.9	7.6
12EP	11.0	8.5
14EP	12.8	9.8
16EP	14.6	11.2
18EP	16.5	12.7
20EP	18.3	14.0
22EP	20.1	15.4
24EP	22.0	16.8
26EP	23.7	18.2
28EP	25.5	19.6
30EP	27.3	20.9
32EP	29.0	22.3

TORX^{plus} Tamper-Resistant SOCKETS(EPR/EPRL)

	S ₁ (mm)	S ₂ (mm)
10EPR	8.7	8.1
11EPR	9.4	8.6
12EPR	10.4	9.6
14EPR	12.1	11.1
16EPR	13.8	12.7
20EPR	17.3	15.8
22EPR	19.0	17.4
24EPR	20.7	19.0
26EPR	22.4	20.0
28EPR	24.1	22.0
30EPR	25.7	23.6
32EPR	27.4	25.1

XZN BITS

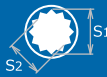
	S ₁ (mm)	S ₂ (mm)
M4	3.6	3.1
M5	4.8	4.1
M6	6.1	5.1
M8	7.3	6.1
M10	9.7	8.1
M12	11.5	9.7
M14	13.3	11.2
M16	15.7	13.2
M18	16.9	14.2

Ribe CV BITS

	W (mm)	S ₁ (mm)	S ₂ (mm)
M5	1.2	5.0	3.8
M6	1.3	6.0	4.5
M7	1.4	7.0	5.0
M8	1.8	8.0	6.0
M9	2.0	9.0	7.1
M10	2.3	10.0	7.4
M12	2.6	12.0	9.0
M13	3.1	13.0	11.0
M14	3.2	14.0	10.4
M16	3.6	16.0	11.9

LHstix® LH-S SOCKETS

	S ₁ (mm)	S ₂ (mm)
LH3S	3.8	4.7
LH4S	4.5	6.0
LH5S	5.6	7.5
LH6S	6.8	9.0
LH7S	7.9	10.5
LH8S	9.0	12.0
LH10S	11.3	15.0
LH12S	13.6	18.0
LH14S	15.8	21.0
LH16S	18.1	24.0

TORX® is a registered trademark of CAMCAR Innovations.
 TORX® ist ein registriertes Markenzeichen der Firma CAMCAR Innovations.
 TORX® est une marque déposée de CAMCAR Innovations.

TORX^{plus} is a registered trademark of CAMCAR Innovations.
 TORX^{plus} ist ein registriertes Markenzeichen der Firma CAMCAR Innovations.
 TORX^{plus} est une marque déposée de CAMCAR Innovations.

LHstix® is a registered trademark of OSG SYSTEM PRODUCTS CO., LTD.
 LHstix® ist ein registriertes Markenzeichen der Firma OSG SYSTEM PRODUCTS CO., LTD.
 LHstix® est une marque déposée de OSG SYSTEM PRODUCTS CO., LTD.

Conversion Table: American Inches-Decimal Inches-Millimeter

in	dec.in.	Millimeter(mm)											
		0"	1"	2"	3"	4"	5"	6"	7"	8"	9"	10"	11"
1/64	0	0	25.4000	50.8000	76.2000	101.6000	127.0000	152.4000	177.8000	203.2000	228.6000	254.0000	279.4000
1/32	0.01563	0.3969	25.7969	51.1969	76.5969	101.9969	127.3969	152.7969	178.1969	203.5969	228.9969	254.3969	279.7969
3/64	0.04688	1.1906	26.5906	51.9906	77.3906	102.7906	128.1906	153.5906	178.9906	204.3906	229.7906	255.1906	280.5906
1/16	0.06250	1.5875	26.9875	52.3875	77.7875	103.1875	128.5875	153.9875	179.3875	204.7875	230.1875	255.5875	280.9875
5/64	0.07813	1.9844	27.3844	52.7844	78.1844	103.5844	128.9844	154.3844	179.7844	205.1844	230.5844	255.9844	281.3844
3/32	0.09375	2.3813	27.7813	53.1813	78.5813	103.9813	129.3813	154.7813	180.1813	205.5813	230.9813	256.3813	281.7813
7/64	0.10938	2.7781	28.1781	53.5781	78.9781	104.3781	129.7781	155.1781	180.5781	205.9781	231.3781	256.7813	282.1781
1/8	0.12500	3.1750	28.5750	53.9750	79.3750	104.7750	130.1750	155.5750	180.9750	206.3750	231.7750	257.1750	282.5750
9/64	0.14063	3.5719	28.9719	54.3719	79.7719	105.1719	130.5719	155.9719	181.3719	206.7719	232.1719	257.5719	282.9719
5/32	0.15625	3.9688	29.3688	54.7688	80.1688	105.5688	130.9688	156.3688	181.7688	207.1688	232.5688	257.9688	283.3688
11/64	0.17188	4.3656	29.7656	55.1656	80.5656	105.9656	131.3656	156.7656	182.1656	207.5656	232.9656	258.3656	283.7656
3/16	0.18750	4.7625	30.1625	55.5625	80.9625	106.3625	131.7625	157.1625	182.5625	207.9625	233.3625	258.7625	284.1625
13/64	0.20313	5.1594	30.5594	55.9594	81.3594	106.7594	132.1594	157.5594	182.9594	208.3594	233.7594	259.1594	284.5594
7/32	0.21875	5.5563	30.9563	56.3563	81.7563	107.1563	132.5563	157.9563	183.3563	208.7563	234.1563	259.5563	284.9563
15/64	0.23438	5.9531	31.3531	56.7531	82.1531	107.5531	132.9531	158.3531	183.7531	209.1531	234.5531	259.9531	285.3531
1/4	0.25000	6.3500	31.7500	57.1500	82.5500	107.9500	133.3500	158.7500	184.1500	209.5500	234.9500	260.3500	285.7500
17/64	0.26563	6.7469	32.1469	57.5469	82.9469	108.3469	133.7469	159.1469	184.5469	209.9469	235.3469	260.7469	286.1469
9/32	0.28125	7.1438	32.5438	57.9438	83.3438	108.7438	134.1438	159.5438	184.9438	210.3438	235.7438	261.1438	286.5438
19/64	0.29688	7.5406	32.9406	58.3406	83.7406	109.1406	134.5406	159.9406	185.3406	210.7406	236.1406	261.5406	286.9406
5/16	0.31250	7.9375	33.3375	58.7375	84.1375	109.5375	134.9375	160.3375	185.7375	211.1375	236.5375	261.9375	287.3375
21/64	0.32813	8.3344	33.7344	59.1344	84.5344	109.9344	135.3344	160.7344	186.1344	211.5344	236.9344	262.3344	287.7344
11/32	0.34375	8.7313	34.1313	59.5313	84.9313	110.3313	135.7313	161.1313	186.5313	211.9313	237.3313	262.7313	288.1313
23/64	0.35938	9.1281	34.5281	59.9281	85.3281	110.7281	136.1281	161.5281	186.9281	212.3281	237.7281	263.1281	288.5281
3/8	0.37500	9.5250	34.9250	60.3250	85.7250	111.1250	136.5250	161.9250	187.3250	212.7250	238.1250	263.5250	288.9250
25/64	0.39063	9.9219	35.3219	60.7219	86.1219	111.5219	136.9219	162.3219	187.7219	213.1219	238.5219	263.9219	289.3219
13/32	0.40625	10.3188	35.7188	61.1188	86.5188	111.9188	137.3188	162.7188	188.1188	213.5188	238.9188	264.3188	289.7188
27/64	0.42188	10.7156	36.1156	61.5156	86.9156	112.3156	137.7156	163.1156	188.5156	213.9156	239.3156	264.7156	290.1156
7/16	0.43750	11.1125	36.5125	61.9125	87.3125	112.7125	138.1125	163.5125	188.9125	214.3125	239.7125	265.1125	290.5125
29/64	0.45313	11.5094	36.9094	62.3094	87.7094	113.1094	138.5094	163.9094	189.3094	214.7094	240.1094	265.5094	290.9094
15/32	0.46875	11.9063	37.3063	62.7063	88.1063	113.5063	138.9063	164.3063	189.7063	215.1063	240.5063	265.9063	291.3063
31/64	0.48438	12.3031	37.7031	63.1031	88.5031	113.9031	139.3031	164.7031	190.1031	215.5031	240.9031	266.3031	291.7031
1/2	0.50000	12.7000	38.1000	63.5000	88.9000	114.3000	139.7000	165.1000	190.5000	215.9000	241.3000	266.7000	292.1000
33/64	0.51563	13.0969	38.4969	63.8969	89.2969	114.6969	140.0969	165.4969	190.8969	216.2969	241.6969	267.0969	292.4969
17/32	0.53125	13.4938	38.8938	64.2938	89.6938	115.0938	140.4938	165.8938	191.2938	216.6938	242.0938	267.4938	292.8938
35/64	0.54688	13.8906	39.2906	64.6906	90.0906	115.4906	140.8906	166.2906	191.6906	217.0906	242.4906	267.8906	293.2906
9/16	0.56250	14.2875	39.6875	65.0875	90.4875	115.8875	141.2875	166.6875	192.0875	217.4875	242.8875	268.2875	293.6875
37/64	0.57813	14.6844	40.0844	65.4844	90.8844	116.2844	141.6844	167.0844	192.4844	217.8844	243.2844	268.6844	294.0844
19/32	0.59375	15.0813	40.4813	65.8813	91.2813	116.6813	142.0813	167.4813	192.8813	218.2813	243.6813	269.0813	294.4813
39/64	0.60938	15.4781	40.8781	66.2781	91.6781	117.0781	142.4781	167.8781	193.2781	218.6781	244.0781	269.4781	294.8781
5/8	0.62500	15.8750	41.2750	66.6750	92.0750	117.4750	142.8750	168.2750	193.6750	219.0750	244.4750	269.8750	295.2750
41/64	0.64063	16.2719	41.6719	67.0719	92.4719	117.8719	143.2719	168.6719	194.0719	219.4719	244.8719	270.2719	295.6719
21/32	0.65625	16.6688	42.0688	67.4688	92.8688	118.2688	143.6688	169.0688	194.4688	219.8688	245.2688	270.6688	296.0688
43/64	0.67188	17.0656	42.4656	67.8656	93.2656	118.6656	144.0656	169.4656	194.8656	220.2656	245.6656	271.0656	296.4656
11/16	0.68750	17.4625	42.8625	68.2625	93.6625	119.0625	144.4625	169.8625	195.2625	220.6625	246.0625	271.4625	296.8625
45/64	0.70313	17.8594	43.2594	68.6594	94.0594	119.4594	144.8594	170.2594	195.6594	221.0594	246.4594	271.8594	297.2594
23/32	0.71875	18.2563	43.6563	69.0563	94.4563	119.8563	145.2563	170.6563	196.0563	221.4563	246.8563	272.2563	297.6563
47/64	0.73438	18.6531	44.0531	69.4531	94.8531	120.2531	145.6531	171.0531	196.4531	221.8531	247.2531	272.6531	298.0531
3/4	0.75000	19.0500	44.4500	69.8500	95.2500	120.6500	146.0500	171.4500	196.8500	222.2500	247.6500	273.0500	298.4500
49/64	0.76563	19.4469	44.8469	70.2469	95.6469	121.0469	146.4469	171.8469	197.2469	222.6469	248.0469	273.4469	298.8469
25/32	0.78125	19.8438	45.2438	70.6438	96.0438	121.4438	146.8438	172.2438	197.6438	223.0438	248.4438	273.8438	299.2438
51/64	0.79688	20.2406	45.6406	71.0406	96.4406	121.8406	147.2406	172.6406	198.0406	223.4406	248.8406	274.2406	299.6406
13/16	0.81250	20.6375	46.0375	71.4375	96.8375	122.2375	147.6375	173.0375	198.4375	223.8375	249.2375	274.6375	300.0375
53/64	0.82813	21.0344	46.4344	71.8344	97.2344	122.6344	148.0344	173.4344	198.8344	224.2344	249.6344	275.0344	300.4344
27/32	0.84375	21.4313	46.8313	72.2313	97.6313	123.0313	148.4313	173.8313	199.2313	224.6313	250.0313	275.4313	300.8313
55/64	0.85938	21.8281	47.2281	72.6281	98.0281	123.4281	148.8281	174.2281	199.6281	225.0281	250.4281	275.8281	301.2281
7/8	0.87500	22.2250	47.6250	73.0250	98.4250	123.8250	149.2250	174.6250	200.0250	225.4250	250.8250	276.2250	301.6250
57/64	0.89063	22.6219	48.0219	73.4219	98.8219	124.2219	149.6219	175.0219	200.4219	225.8219	251.2219	276.6219	302.0219
29/32	0.90625	23.0188	48.4188	73.8188	99.2188	124.6188	150.0188	175.4188	200.8188	226.2188	251.6188	277.0188	302.4188
59/64	0.92188	23.4156	48.8156	74.2156	99.6156	125.0156	150.4156	175.8156	201.2156	226.6156	252.0156	277.4156	302.8156
15/16	0.93750	23.8125	49.2125	74.6125	100.0125	125.4125	150.8125	176.2125	201.6125	227.0125	252.4125	277.8125	303.2125
61/64	0.95313	24.2094	49.6094	75.0094	100.4094	125.8094	151.2094	176.6094	202.0094	227.4094	252.8094	278.2094	303.6094
31/32	0.96875	24.6063	50.0063	75.4063	100.8063	126.2063	151.6063	177.0063	202.4063	227.8063	253.2063	278.6063	304.0063
63/64	0.98438	25.0031	50.4031	75.8031	101.2031	126.6031	152.0031	177.4031	202.8031	228.2031	253.6031	279.0031	304.4031
		12"	13"	14"	15"	16"	17"	18"	19"	20"	21"	22"	23"
in.	dec.in.	Millimeter(mm)											
		304.8000	330.2000	355.6000	381.0000	406.4000	431.8000	457.2000	482.6000	508.0000	533.4000	558.8000	584.2000
1/32	0.03125	305.5938	330.9938	356.3938	381.7938	407.1938	432.5938	457.9938	483.3938	508.7938	534.1938	559.5938	584.9938
1/16	0.06250	306.3875	331.7875	357.1875	382.5875	407.9875	433.3875	458.7875	484.1875	509.5875	534.9875	560.3875	585.7875
3/32	0.09375	307.1813	332.5813	357.9813	383.3813	408.7813	434.1813	459.5813	484.9813	510.3813	535.7813	561.1813	586.5813
1/8	0.12500	307.9750</											

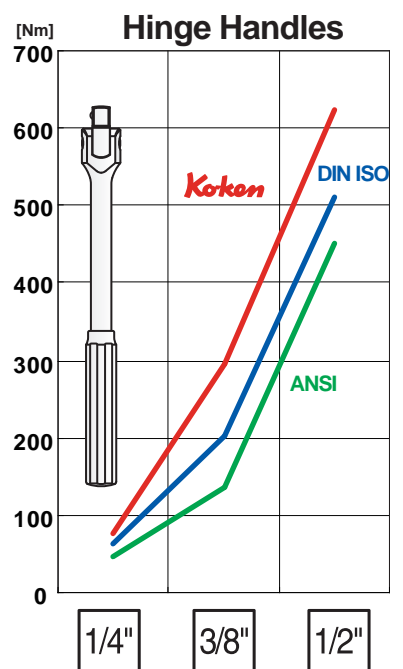
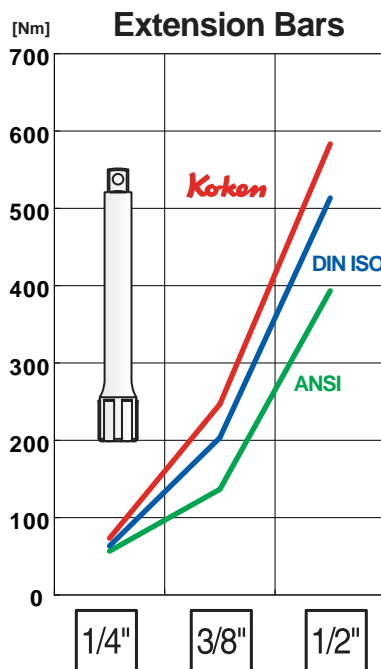
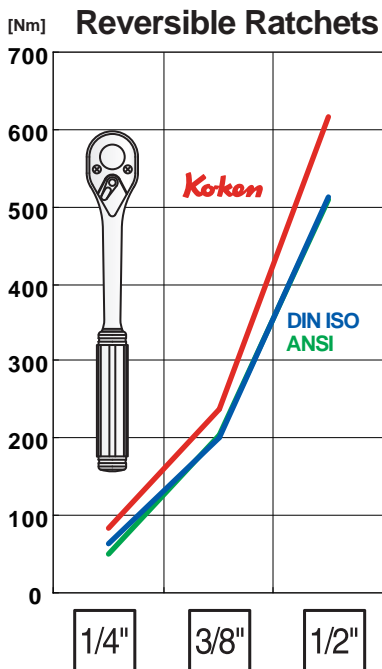
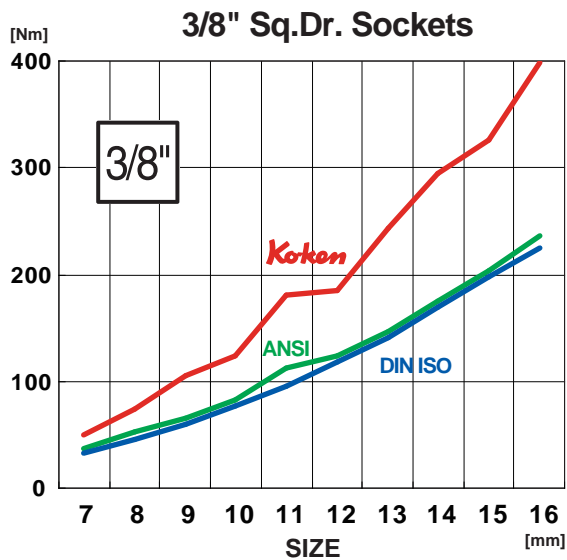
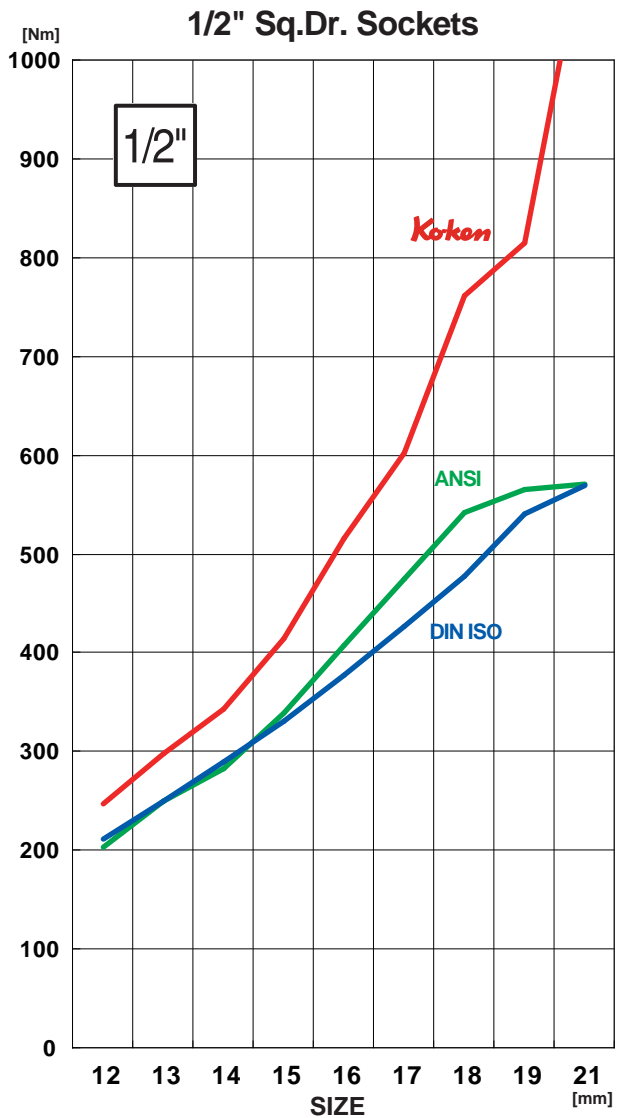
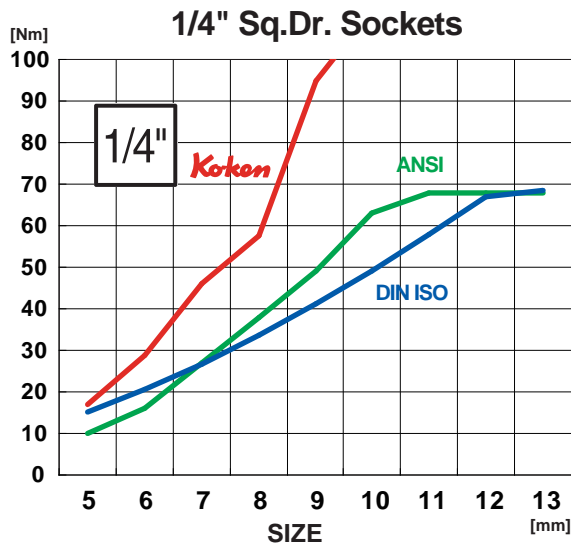

Numerical Index

10099A	260	123PG	172	13430M	202	14400A	212
100H	168	123PN	172	13440A	202	14400M	212
100P	168	123PT	172	13440M	202	14400M-FR	274
100P (PZ)	168	12400A	190	13440T	202	14400MG	214
100S	168	12400AG	190	13460A	197	14401A	213
100T (T)	168	12400M	190	13460AG	197	14401LH	214
100T (TH)	169	12400MG	190	13460M	197	14401M	213
100X (XZN)	169	12410M	190	13460MG	197	14401MS	214
101A	157	12425	191	13465M	197	14405A	212
101B	156	12460A	191	135AL	179	14405M	212
101H	156	12460AG	191	135E	179	14406A	213
101P	156	12460M	191	137	155	14406M	213
101S	156	12460MG	191	13760	210	14410M	214
101T (T)	156	12465M	191	13760-P.FR	273	14415M	215
101T (TH)	156	124M-600 (2B)	160	13770	211	14425	215
102KA	152	12760	193	13771	211	14425 (EPL)	215
102KM	152	12770	193	13772	211, 295	14433A	229
102KM.BH	152	127C	286	138	155	14440A	219
102KT	152	128H	157	139	155	14440M	219
102NA	152	128T	157	14012M	222	14444AL	228
102NM	152	13012M	205	14025	222	14444WA	228
103KA	153	13025	205	14100A	145, 219	14455A	229
103KA.BH	153	13103M	147, 203	14100M	145, 219	14465M	215
103KM	153	13134	177, 205	14101M	301	14466A	229, 304
103KT	153	13134M	208	14101MP	300	14466AL	228
10400A	260	13134T (IP)	208	14101MP-M/8	300	14488A-B	304
10400M	260	13134T (T)	208	14103M	147, 219	144KM	287
104A	159	13134X (XZN)	208	14106	226	145KD	292
104ME	159, 307	13137E	171	14112-P	301	145KM-10H	153
106	291	13139	167, 209	14113J	299	145LH3/8F	293
107-16	226, 240, 250	13140	169, 209	14113M	299	14760	228
107-16 (IP)	226, 240, 250	13142-D6.3	167, 209	14118M	298	14760-P.FR	274
107-16 (T)	226, 240, 250	13142-F11.2	177, 205	14124	299	14770	229
107-16 (XZN)	226, 240, 250	13142-F6.3	171, 209	14124/3	299	14771	229
107-22	241, 251	13145A-150	295	14134	177, 222	14772	229, 295
107-22 (T)	241, 251	13145M	203	14134M	225	148KM	287
107-32	252, 256	13145M (12P)	204, 289	14134T (IP)	225	150-10H	153
108A	166	13145MG	203	14134T (T)	225	150-14H	292
108H	166	13146M	204	14134X (XZN)	225	15300M	233
108P	166	13147M	204	14137E	171	15310M	233
108S	166	13242M	211	14139	167, 227	15400A	232
108T (T)	166	13300A	200	14140	169, 227	15400M	232
108T (TH)	166	13300G	201	14142-D6.3	167, 227	15410M	232
110	178	13300G-FR	273	14142-F11.2	177, 222	154K	292
110AL	178	13300M	200	14142-F6.3	171, 227	154M	154
112	178	13300M-FR	273	14145A-150	295	154ML	154
112AL	179	13300XG	200	14145M	220	155	307
113	173	13301A	200	14145M-110MB	297	15544A	233
113 (2B)	173	13301M	200	14145MG	220	15555AL	233
113 (E)	173	13301X	199	14145PM-110	297	15566A	233
113-SV	275	13305M	201	14146M	221	156M	159
113UN	175	13306M	201	14147M	221	15770	233
115	174	13310M	201	14201M	297	157HE	161, 307
115-SV	275	13322A	211	14207M	231	157PE	161, 307
115G	175	13325	202	14208M	231	157S	161
115G-FR	275	13333AL	210	14209M	230	157T	161, 307
117	180	13333WA	210	14210M	230	158	291
119	175	13344A	211	14210T	230	160K	148
120	180	13365M	201	14210X	230	16101M	301
1202	157	13400-WN	199	14218M	298	16102M	302
1203	153	13400A	194	14219M	298	16106	239
1206	154, 292	13400AG	196	14241M	231	16106-16	239
1210E	292	13400M	194	14242M	231	16106-16 (T)	239
1212	294	13400M-FR	273	14245M	231	16106-16 (XZN)	239
12137E	171	13400MG	196	14300A	216	16107	241
12139	167, 192	13401A	195	14300G	218	16107-22	241
12140	169, 192	13401LH	199	14300G-FR	274	16134	177
12142-F6.3	171, 192	13401M	195	14300M	216	16201A	243
121H	170	13401MS	196	14300M-FR	274	16201M	243
121P	170	13405A	194	14301A	217	16245M	243
121T (IP)	171	13405M	194	14301M	217	162E	313
121T (T)	170	13406A	195	14301X	216	16300A	237
121T (TH)	171	13406M	195	14305M	217, 295	16300M	237
12222AL	193	13410M	196	14306M	217	16301A	238
12233A	193	13425	198	14310M	218	16301M	238
12300G	192	13425 (EPL)	198	14325	218	16301X	236
12300M	192	13425 (EPRL)	198	14365M	218	16305M	237, 289
12365M	192	13425EG	198	14400-WN	215	16310M	238

16316A	304	18108-32	252	2300XZ	024	2755	061
16316M	304	18300A	247	2305A	052	2756	061
16317A	304	18300M	247	2305M	052	2756Z	028
16317M	304	18301A	248	23103M	147, 280	2756Z-1/2	028
16325	238	18301M	248	2310M	053	2756Z-3/8	028
16400A	234	18301X	247	2325	053	2760	062
16400M	234	18310M	248	23300A	280	2760Z	028
16401A	235	18316A	304	23300M	280	2762	061
16401M	235	18316M	304	23305M	280	2763	062
16405A	234	18317A	304	23310M	280	2768J	062
16405M	234	18317M	304	23325	280	2768P	062
16410M	235	183H	176, 206, 223, 264	23400A	279	2769H	063
16425	236	183H-B	176, 206, 223, 264	23400M	279	2769N	063, 186
16425 (EPL)	236	183T (IP)	177, 207, 224, 265	23405M	279	2769NWF	063, 186
165BM	172	183T (T)	176, 207, 224, 264	23410M	279	2770	064
165LM	172	183X (XZN)	177, 207, 224, 265	23425	279	2771	064
16644A	242	18400A	244	2350G-12PSG	287	2771Z	028
16644AL	242	18400M	244	2350M	053	2772Z	028
16655A	242	18401A	245	2350X	051	2774J	061
16666AL	242	18401M	245	23760-P	280	2774JS	060
16688A	242	18405A	245	2400A	048	2774JS-3/8	092
166P	184	18405M	245	2400M	048	2774N	061
166PS/6	184	18405M (D)	246	2400MZ	024	2774P	061
166S	184	18410M	246	2400W-BA	049	2774P-1/4HF	167
16760	241	184E-64	311	2405A	048	2774P-5/16HF	169
16770	242	186	180	2405M	048	2774PS	060
16771	242	18760	252	24103M	147, 282	2774PS-3/8	092
167A	182	18770	253	2410M	049	2780	064
167C (2B)	182	18771	253	2415A	049	2785	064
167C/3-2B	182	18866A	253	2415M	049	280PM	298
167M	182	18877A	253	2425	051	3000 (PH)	080
168C	185	18888AL	253	24300A	282	3000 (PZ)	080
168CS	185	19300M	259	24300M	282	3005	080
168H-B	183	19400A	258	24305M	282	3010A	081
168P	185	19400M	258	2430M	055	3010M	081
168P (PZ)	183	19760	259	2430T	055	3010MZ	032
168PS/6	185	19770	259	24310M	282	3011M	083
168S	185	19977A	259	24400A	281	3012A	082
168T (250)	294	2000 (PH)	055	24400M	281	3012M	082
168T (TH)	183	2000 (PZ)	055	24405M	281	3012M-25	291
168T/7 (TH)	183	2000Z	025	2440A	054	3015M	083
169	294	2005	055	2440M	054	3020	084
169/2	294	2005Z	025	2440T	054	3025 (IP)	087
169BP	294	2010A	056	24410M	281	3025 (IPR)	088
169HR	294	2010M	056	2441M	054	3025 (T)	085
169HR/2	294	2010MZ	025	2441MZ	025	3025 (TH)	086
169WM	294	2011M	056	24425	281	3025-100R (T)	085
170S	315	2020	056	2445A	054	3025-100R (TH)	086
171	315	2025 (IP)	058	2445M	054	3025Z	032
17108	256	2025 (IPR)	058	2450AS	050	3027	088
17108-32	256	2025 (T)	057	2450MS	050	3110A	089, 290
171B-1/2	315	2025 (TH)	057	2455AS	050	3110M	089, 290
171S	315	2025Z	026	24760-P	282	3110MGH	290
171SB-1/2	315	2120	061	2715	162	3112G	164
172	315	2127	149	2725Z	026	3116M	160
17300A	255	2137	058, 167	2725Z-160	026	3117M	079
17300M	255	2138	058, 169	2725Z-3/8	033	3119	089, 313
17400A	254	22300A	278	2725Z-3/8 (L160)	033	3127	149
17400M	254	22300M	278	2725ZB-3/8	034	3128 (L80)	149
17405A	255	2233A	064	2725ZB-3/8 (L160)	034	3129	151
17405M	255	22400M	278	2726Z	027	3131A	148
17760	257	22425	278	2726Z-160	027	3131E	148
17770	257	2251A	065	2726Z-3/8	035	3132	148
17788A	257	2251M	065	2726Z-3/8 (L160)	035	3137	089, 167
17799A	257	2254M	157	2726ZB-3/8	036	3138	089, 169
178-10H	287	2258M	065	2726ZB-3/8 (L160)	036	3201AMW	099, 308
179B-12H	292	2259M	066	2749P-1/4HF	167	3206AM	099
180M	167	2263A	066, 308	2749P-3/8	090	3210A	099
18101M	301	2275	066	2749P-5/16HF	169	3210M	099
18102M	302	2276	066	2749PS-3/8	090	3216	100
18104M	248	2277	066	2753J	059	3217M	100
18106	249	2285ZE	029	2753JB	060	3225A	286
18106-16	249	2286Z	029	2753N	059	3247	086, 293
18106-16 (T)	249	2300A	052	2753NB	060	3250M	100
18106-16 (XZN)	249	2300M	052	2753P	059	3251	101
18107	251	2300MZ	024	2753P-160	059	3252M	101
18107-22	251	2300W-BA	053	2753PB	060	3264	148
18108	252	2300X	051	2753PS	059	3275	101

Numerical Index

3277	101	3716	162	4020	114	4405M (DU)	306
3278	101	3725Z	033	4020-60 (MH)	290	4405W	104
3285Z	039	3725Z-280	033	4025 (IP)	116	4406M	102
3285ZA	039	3725ZB	034	4025 (T)	115	4410M	104
3285ZE	039	3725ZB-280	034	4027	116	4425	105
3286Z	039	3725ZS	033	4100A	144	4425 (EPL)	105
3300A	073	3725ZSB	034	4100M	144	4425 (EPRL)	105
3300C	284, 285	3726Z	035	4101	117, 295	4425-N	104, 295
3300CB	284	3726Z-280	035	4102	291	4433A	125
3300CZ	031	3726ZB	036	4103A	146	4440A	110
3300FN	075, 288	3726ZB-280	036	4103M	146	4440M	110
3300M	073	3726ZS	035	4104	146	4440T	110
3300M (L120)	076	3726ZSB	036	4109M	290	4445A	110
3300M/4	293	3749S	090	4110A	117, 290	4445M	110
3300M/4-L120	076, 293	3749S-1/2	118	4110M	117, 290	4450M	106
3300MZ	031	3749SB	090	4111M	290	4466A	125
3300P	284	3749SB-1/2	118	4112G	164	4711X	163, 296
3300S	285	3751J	286	4112N	164	4711XZ	041
3300W	074	3752J	091	4117M	109	4715	163
3300X	072	3752N	091	4122-72	288	4715S	163
3300XA	072	3753J	091	4127	150	4715SL	163
3300XZ	030	3753JB	092	4128 (L120)	150	4725Z	040
3305A	073	3753N	091	4129	151	4725ZB	040
3305M	073	3753NB	092	4131A	148	4747	125
3305M (L120)	076	3753P	091	4132	148	4749J-380	121
3305M/4-L120	076	3753P-250	091	4133	288	4749N-380	121
3305P	284, 285, 307	3753PB	092	4137	117, 167	4750J	119
3305P-12	307	3753SM	090	4138	117, 169	4750JB	119
3305PZ	031	3753SMB	090	4202	291	4750N	119
3305W	074	3755	095	4203M	146	4750NB	119
3305X	072	3756	095	4203MF	146	4750P	119
3305XA	072	3756Z	038	4211A	144	4750PB	119
3310M	074	3756Z-1/2	038	4211M	144	4752J	118
3322A	098	3756ZS	038	4214M	144	4752N	118
3322AZ-75	038	3757	095	4223M	126	4753J	120
3325	075	3760	096	4238AM	126, 308	4753JB	120
3340C	285	3760LZ	037	4241A	127	4753N	120
3340M	078	3760Z	037	4241M	127	4753NB	120
3341G	287	3762	095	4249M	127	4753P	120
3342G-150	287	3763	096	4250M	127	4753P-410	121
3344A	098	3768J-250	097	4251A	128, 308	4753PB	120
3345P	285	3768P-250	097	4251M	128	4755	122
3350A (L120)	076	3768P-380	097	4252M	128	4756	122
3350M	075	3768Z-250	037	4254	128	4756Z	043
3350M (L120)	076	3768Z-400	037	4262M	128	4760	123
3350M/2	293	3769H	097	4272AM	129	4760LZ	042
3350M/2-L120	076, 293	3769N	097, 186	4275	129	4760Z	042
3350X	072	3769NWF	097, 186	4276	129	4763	123
3400A	068	3770	098	4277	129	4768J	122
3400LH	070	3771	098	4282	293	4768P	122
3400M	068	3771Z	037	4285Z	044	4768Z-430	041
3400M-24	291	3772Z	037	4285ZE	044	4770	124
3400MZ	030	3774J	093	4300A	107	4771	124
3400W	069	3774JB	093	4300C	284	4771Z	042
3405A	068	3774JBL	094	4300H	289	4772Z	043
3405M	068	3774JL	093	4300H (8P)	289	4774J	121
3405W	069	3774N	093	4300M	107	4774JB	122
3410M	069	3774NB	093	4300M (L110)	296	4774N	121
3415A	070	3774NL	093	4300M (L120)	109	4774NB	122
3415M	070	3774P	093	4300M (L60)	296	4774P	121
3425	070	3774P-SR	094	4300PMZ	041	4774P-450	121
3425 (2B)	071	3774PB	093	4300S	285	4774PB	122
3430M	079	3774PL	093	4305A	107	4780-400	124
3440A	077	3774PS	092	4305M	107	4781N-450	124
3440M	077	3776J	094	4310M	108	4785	124
3440T	077	3776N	094	4325	108	4788	125
3441M	078	3776P	094	4325 (L140)	109	6012M	131
3441MZ	032	3780	098	4325 (L140)-2B	109	6100M	145
3445A	077	3785	098	4340C	285	6101	131, 295
3445M	077	4000 (PH)	110	4400A	103	6102M-400	302
3445W	077	4000 (PZ)	110	4400LH	106	6112	164
3450A	071	4005	110	4400M	102	6201A	135
3450M	071	4010A	111	4400M (DU)	306	6201M	135
3450MH	071	4010M	111	4400MZ	040	6212M	135
3715	162	4010M (12P)	289	4400W	104	6300A	131
3715S	162	4012A	113	4401M	102	6300M	131
3715SL	162	4012M	112	4405A	103	6305A	131
3715SLK	162	4012M-43	306	4405M	102	6305M	131

6400A	130	ENH2003	065	RS20XXZ/9	025	RS3400MZ/8	030
6400M	130	ESH2001	065	RS2127/10	149	RS3400W/7	069
6405A	130	ESH3001	099	RS2127/6	149	RS3405A/9	068
6405A (MV)	306	ETH3001	099	RS2300A/9	052	RS3405M/12	068
6405M	130	HA001	314	RS2300M/12	052	RS3405W/7	069
6425	130	HA003	314	RS2300MZ/12	024	RS3410M/12	069
6644A	134	NV13134	265	RS2300X/12	051	RS3425/4 (2B)	071
6688A	134	NV13145	263	RS2300XZ/9	024	RS3425/9	070
6749	132	NV13400	263	RS2305A/9	052	RS3430M/6	079
6749-HEAD	132	NV13760-P	263	RS2305M/12	052	RS3440A/8	077
6752	132	NV14134	265	RS2310M/12	053	RS3440M/8	077
6752-HEAD	132	NV14145	266	RS2350M/4	053	RS3440T/8	078
6755	133	NV14400	266	RS2350X/4	051	RS3441M/11	078
6760	133	NV14433A-P	266	RS2400A/9	048	RS3445W/7	077
6768	133	NV14760-P	266	RS2400M/12	048	RS3450A/9	071
6768-HEAD	133	NV16400	267	RS2400MZ/12	024	RS3450M/10	071
6770	134	NV16760	267	RS2400W/9-BA	049	RS3450M/8	071
6785	134	O-Ring	269	RS2405A/9	048	RS3450MH/6	071
6788	134	P14145M/5	297	RS2405M/12	048	RS3X00MZ/12	031
8012M	137	P2201AM	067	RS2410M/12	049	RS4010A/10	111
8102M-400	302	P2251M	067	RS2425/6	051	RS4010M/10	111
8225M	140	P2258M	067	RS2441M/11	054	RS4012A/10	113
8400A	136	P2285Z	029	RS2445A/9	054	RS4012M/10	112
8400M	136	Pin	269	RS2450AS/6	050	RS4020/6	114
8405A	136	PIPE	132, 133, 138	RS2450MS/11	050	RS4025/9	115
8405M	136	PK115/7	174	RS2455AS/6	050	RS4025/9-IP	116
8749	138	PK166PS/6	184	RS3010A/8	081	RS4027/7	116
8749-HEAD	138	PK168PS/6	185	RS3010M/8	081	RS4127/6	150
8760	137	PK2346/6	098	RS3010MZ/8	032	RS4129/5	151
8768	138	PK2760/6	062	RS3012A/8	082	RS4300A/10	107
8768-HEAD	138	PK2763/6	062	RS3012M/8	082	RS4300M/10	107
8770	137	PK3760/6	096	RS3015M/8	083	RS4300M/12	107
8785	138	PK3763/6	096	RS3020/6	084	RS4305A/10	107
8788	138	PK4760/5	123	RS3020/7	084	RS4305M/10	107
8866A	137	PK4763/5	123	RS3025/8	085	RS4310M/10	108
AG112A	165	PS6	303	RS3025/8-IP	087	RS4325/7	108
AG112F	165	PS8	303	RS3025/8-L100R	085	RS4400A/10	103
AG112H	165	Puller	268	RS3025/8-L100RH	086	RS4400LH/6	106
AG318A	165	PW6P	303	RS3025/9-HOLE	086	RS4400MZ/10	040
AN112A	165	PW8L	303	RS3025/9-IPR	088	RS4400W/8	104
AN112C	165	PW8P	303	RS3025Z/8	032	RS4401M/10	102
AN14300	298	PW8P/4	303	RS3027/5	088	RS4405A/10	103
AS2305A	052	R810	155	RS3127/8	149	RS4405W/8	104
AS2405A	048	R810A	158	RS3129/6	151	RS4406M/10	102
AS2445A	054	R810B	158	RS3300A/9	073	RS4410M/10	104
BD004	313	R810C	158	RS3300FN/8	075, 288	RS4425/6-EPL	105
BD008E-165	311	R810D	158	RS3300M/12	073	RS4425/6-N	104, 295
BD011SE	311	R810E	158	RS3300MZ/12	031	RS4425/7	105
BD014E	310	RS13012M/8	205	RS3300MZ/8	031	RS4450M/10	106
BD014E-140	310	RS13025/8	205	RS3300W/7	074	RSAL	044
BD014E-SF	311	RS13301X/9	199	RS3300X/8	072	RSAL200	044
BD014SE	310	RS13400M/11	194	RS3300XA/9	072	RSAL300	044
BD014XE-SF	311	RS13401M/9	195	RS3300XZ/12	030	RSAS2305A/10	052
BD016E	312	RS13401MS/11	196	RS3300XZ/8	030	RSAS2405A/10	048
BD016JE	312	RS14012M/10	222	RS3305A/9	073	RSX025/11-IP	087
BD017E	312	RS14025/6	222	RS3305M/12	073	RSX025/11-IPR	088
BD018	313	RS14124/7	299	RS3305W/7	074	RSX425/14	070
BD022-120P	314	RS14301X/10	216	RS3305X/8	072	RSX772Z/3	043
BD023E	314	RS14401M/10	213	RS3305XA/9	072	S3240A	100
BD024E	314	RS14401MS/10	214	RS3310M/12	074	S3240M	100
BD042E	310	RS14405M/11	212	RS3325/9	075	S4240A	126
BD14400MJ	312	RS2010A/8	056	RS3340M/8	078	S4240M	126
BIT-60E	310	RS2010M/7	056	RS3350M/5	075	SP4122-69	288
C-Ring	268	RS2025/7	057	RS3350X/4	072	SP4300M	288
C-Ring Set	268	RS2025/7-HOLE	057	RS3400A/9	068	SP4305M-77	288
CLIP.P/5	044	RS2025/7-IP	058	RS3400LH/7	070	ST4027-140	289
D3753J	091	RS2025/7-IPR	058	RS3400M/12	068	TI4261M	142
D4753J	120	RS2025Z/7	026	RS3400MZ/12	030		

Reproduction in whole or in part without proper and prior authorization is prohibited.
Der Nachdruck, im ganzen oder auch auszugsweise, bedarf unserer ausdrücklichen,
vorherigen Genehmigung.

La reproduction de ce catalogue en tout ou en partie sans autorisation préalable est
interdite.

本商品目錄之全部版權,係歸於株式會社山下工業研究所(Kokon TOOL CO.,LTD.)所有,不論其部分或
全部,未經本公司許可,均不得複製

